



# Owner's Manual

## MODEL CMA180VL-FL Installation and Operation Manual Rev 2.00A



**CMA DISHMACHINES**  
**12700 KNOTT AVENUE**  
**GARDEN GROVE, CALIFORNIA 92841**  
**800-854-6417**  
FAX 714-895-2141

[www.cmadishmachines.com](http://www.cmadishmachines.com)

# Table of Contents

## Model CMA180VL-FL

- 1. SPECIFICATIONS..... 4**
  - 1.1 CMA180VL-FL..... 4
- 2. GETTING STARTED ..... 6**
  - 2.1. Introduction to CMA180VL-FL ..... 6
    - 2.1.1. *Plumbing Chart* ..... 7
  - 2.2. Receiving and Installation ..... 8
    - 2.2.1. *Electrical* ..... 8
    - 2.2.2. *Plumbing*..... 8
    - 2.2.3. *Chemical Dispensers* ..... 9
    - 2.2.4. *Water Tempering Kit (Optional)*.....10
    - 2.2.5. *Installation Checklist* .....11
    - 2.2.6. *Machine Start-Up Procedures* .....11
    - 2.2.7. *Electrical Requirements*.....13
- 3. WIRING OPTIONS..... 14**
- 4. QUICK SERVICE GUIDE ..... 15**
- 5. INITIAL PARTS KIT P/N 1100.17 ..... 16**
- 6. AUTO-FILL SOLID STATE TIMER ..... 17**
- 7. WIRE DIAGRAM CMA180VL-FL 240V ..... 18**
- 8. WIRE DIAGRAM CMA180VL-FL 240V BOOSTER ONLY ..... 19**

# 1. Specifications

		Metric Equivalent
<b>1.1 CMA180VL-FL</b>		
<b>WATER CONSUMPTION</b>		
PER RACK	.89 G	(3.37 L)
PER HOUR	19 G	(72 L)
<b>OPERATING CYCLE</b>		
WASH TIME-SEC	48	48
RINSE TIME-SEC	12	12
VENT FAN -SEC	110	110
TOTAL CYCLE-SEC	170	170
<b>OPERATING CAPACITY</b>		
RACKS PER HOUR (NSF rated)	21	21
WASH TANK CAPACITY	8 GAL.	(30.3 L)
PUMP CAPACITY	52 GPM	(197 LPM)
<b>WATER REQUIREMENTS</b>		
COLD WATER	41°F-65°F	(5°C-18°C)
HOT WATER	120 F°-140F°	52°C -60°C
HOT WATER INLET	½"	1.3cm
COLD WATER INLET	½"	1.3cm
DRAIN CONNECTION	2"	5.1cm
RINSE PRESSURE SET	20 PSI ±5 PSI	1.41 kg/cm <sup>2</sup>
<b>CYCLE TEMPERATURES</b>		
WASH-°F	155°F-160°F	(68°C/71°C)
RINSE-°F	180°F-195°F	(82°C/90°C)
<b>DIMENSIONS</b>		
DEPTH	29"	(76.7cm)
WIDTH	25 ½"	(65cm)
HEIGHT	85 ¼"-86 ¼"	(216-219)cm
STANDARD TABLE HEIGHT	34"	(86.3cm)
MAX CLEARANCE FOR DISHES	17 ½"	(44cm)
MINIMUM CLEARANCE FOR FAN	6"	(15.2")
RECOMMENDED	12"	(30.4")
DRAIN CONNECTION (OFF FLOOR)	11 ½" – 12½"	(29-32cm)

ELECTRICAL RATING	VOLTS	PHASE	AMPS
	208	1	78
	240	1	88
	208	3	49
	240	3	55
	480	3	25

SHIPPING WEIGHT 332#

**Note:** The required flowing water pressure to the dishwasher is 15-65 PSIG. If pressures higher than 65 PSIG are present, a pressure regulating valve must be installed in the water line to the dishwasher (by others). If flowing pressure is lower than 15 psi, improper machine operation may result.



## 2. Getting Started

---

### 2.1. Introduction to CMA180VL-FL

The CMA180VL-FL is a hot water sanitizing, single rack, door-type dishmachine. It is a stand-alone machine featuring a self-contained booster heater. The only external connections necessary are power supply, water supplies, drainpipe, and chemical dispensers. The machine utilizes re-circulated wash water and fresh water final rinse.

The machine is equipped with the built in Heat Recovery System which reduces significantly the humidity in the dishwashing room. The Heat Recovery System uses the heat of the steam generated during the wash cycles to warm up the in-feed water (41F -65F) before entering the booster heater.

This manual is structured to provide a complete reference guide to the CMA180VL-FL. It is presented in a manner that all users will be able to comprehend and use as an effective tool in supporting the operation and maintenance of the dishmachine. The first section explains how the machine is packaged and what to look for when receiving the machine.

Instructions are provided in the manual explaining how to unpack the machine and then install and set up the machine for use. Requirements are given for plumbing, wiring, and space considerations. *These attributes of the machine are always taken into consideration by our well-trained sales representatives prior to the order being placed.* In the manual, additional installation guidance is given to ensure the machine can run at optimum conditions.

The Operation Section of the manual may be used for instruction and procedures when required. We make this portion of the manual easy to understand so that all levels of operators may be able to read and comprehend the operation of the machine. The function of the machine itself is mostly automatic and takes little training to put into full operation. The Operation Section also includes diagnostic considerations for the machine when problems occur.

CMA warrants the workmanship of the machine.

**Caution:** the CMA-180 VL-FL has a Heat Recovery (HR) system comprised of heat exchange coils that can become restricted or clogged if the water supplied to the machine contains lime scale, also known as hard water condition. The cold water supplied to the CMA-180 VL-FL should be analyzed and treated to maintain maximum 3.5 grains per gallon (gpg) or 60 parts per million (ppm) water hardness to prevent scale build up conditions and to optimize dishmachine operation. The first sign of scale build up conditions will be restricted water flow or having no flow of water to the rinse arms.

**CMA recommends utilizing a water softening system to maintain water hardness measurements of 3.5 gpg or less. This will assure maximum results and optimum operation of the dishmachine.**

#### DISCLAIMERS

CMA expressly disclaims any and all warranties, express or implied, relating to the installation of any and all CMA equipment that is installed by chemical dealers, contracted servicers or third party servicers to CMA equipment. If the installation instructions are not followed exactly (to the letter), or, if any person or company conducting the installation of the CMA equipment, revise the installation procedures or alter the instructions in any manner, the CMA warranty becomes void. If, due to the improper installation of CMA equipment, this equipment ceases to operate properly or affects other parts of the CMA dishwashing equipment, in that the other parts become defective, the CMA warranty becomes void. CMA will not be liable or responsible or warrant CMA equipment, due to improper installation of any CMA model dishwasher.

**CMA does NOT endorse "Tankless On-Demand" water heaters for use on CMA Dishmachine products. On most applications, the volume of hot water required for commercial dishmachines exceeds the capacity of these types of heating sources. You will find that most, if not all, commercial dishmachines have been programmed with auto-filling features that require quick filling, with a designated limited time.**

**CMA DOES endorse, and highly recommends, the standard "tank" style water heaters, sized properly to handle each particular facility with their water heating requirements. A "tank" style water heater stores and supplies a large capacity of preheated water before providing hot water to the dishmachine. To meet required health codes, there must be a reliable and consistent flow of adequate hot water supplied to the dishmachine. If the facilities' "tank" style water heater is marginal in size, CMA recommends installing a proper size Hatco Booster Heater, a CMA's E-Temp 40 or 70-degree-rise Booster Heater (that can be installed on CMA Conveyors), or a CMA Temp-Sure Booster Heater (for door and undercounter dishmachines). All are designed to adequately achieve results.**



## 2.1.1. Plumbing Chart

# CMA-180 VENTLESS

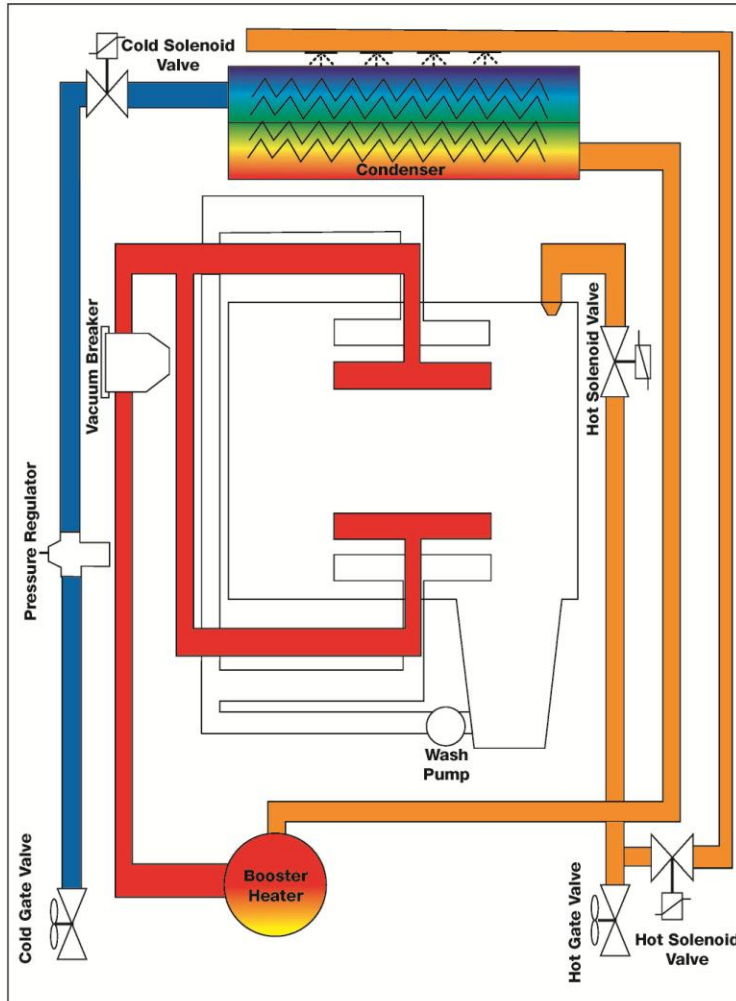

The buildings ambient or cold tap water (41F-65F) is supplied to the dishwasher through the cold water inlet valve located at the bottom of the dishwasher. The ambient/cold water enters the condenser at the top of dishwasher, as the water travels down through the condenser. The steam and heat rising through from the wash cabinet is used to preheat the incoming water to 130 to 140 degrees to feed the dishwashers own booster heater. The booster heater located underneath the wash tank boosts the final-rinse water temperature to 180 to 190 degrees for a proper sanitizing final-rinse. At the end of the 60 second wash-cycle, a 30 second steam evacuation cycle will immediately begin. Once the steam evacuation cycle has been completed, the operation indication light will turn off indicating the cycle has been completed and the rack of dishes can be removed and a new wash-cycle can be started.

The hot water source is used to fill the dishwasher with hot water needed to fill the wash tank, and to flush or clean down the condenser. The flush-down or cleaning of the condenser is only done at the end of day and sometimes after each service when the main power switch is turned to the off position.

## 2.2. Receiving and Installation

Step 1: Remove packaging material.

Step 2: Remove service manual from inside the wash tank.

Step 3: Adjust the feet. Set the machine in place.  
Level the machine side – to – side and front – to –  
back.

Step 4: It is recommended that a distance of at least eight inches (8") be  
between the table scrap sink and the dishmachine.

### 2.2.1. Electrical\*

Prior to installation make sure the electrical supply is compatible with the specifications on the machines data plate.

**WARNING:** Electrical and grounding connections must comply with the applicable portions of the National Electrical Code and/or other local electrical codes.

**Note:** For supply connections, use copper wire only rated at 90 degree C minimum.

The control panel provides a 1" conduit connection point on the rear of the panel. Refer to Section 3 for wiring options.

This machine is equipped to handle both single and three phase applications. See Section 1: Specifications 1.1 for the proper electrical ratings.

### 2.2.2. Plumbing\*

Minimum 140°F hot water supply 1/2". Minimum 41°F cold water supply 1/2"– minimum 20 psi, 6 gpm flow rate and 60 gph recovery rate. Plumbing connections located on the bottom of the machine.

**Notice to Plumber:** The plumber connecting this machine is responsible for making certain that the water lines are THOROUGHLY FLUSHED OUT BEFORE connecting to the dishwasher.

Ask your municipal water supplier for details about your local water conditions prior to installation. Recommended water hardness is 3 grains per gallon or less.

**Note:** high iron levels in the water supply can cause staining and may require an iron filter. High chlorine levels in the water supply can cause pitting and may require a chloride removal system.

If an inspection of the dishwasher or booster heater reveals lime buildup after the equipment has been in service, water treatment is recommended. If water softener is already in place, ensure there is a sufficient level of salt.

The drain is a two inch (2") pipe sleeve attached by "No-Hub" plumbing connection at the bottom of the scrap trap. Account's drain should be no higher than 11" to allow the machine to drain properly.

---

\* Electrical and plumbing connections must be made by qualified person who comply with all available Federal, State, and Local Health, Electrical, Plumbing and Safety codes

### 2.2.3. Chemical Dispensers\*

This machine must be operated with an automatic detergent feeder and, if applicable, an automatic chemical sanitizer feeder, including a visual means to verify that detergents and sanitizers are delivered or a visual or audible alarm to signal if detergents and sanitizers are not available for delivery to the respective washing and sanitizing systems. Please see instructions for electrical and plumbing connections located in this manual and in the feeder equipment manual.

1. Check valves should be installed directly at the mixing chamber coupling located by the vacuum breaker on the back of machine. There are two 1/8" FPT mounting holes provided on the mixing chamber coupling, which will position the check valves parallel to the machine avoiding any chemicals from dripping onto the stainless steel should a leak develop. One hole is for rinse chemical and one for sanitizer chemical, but only one is needed with the High Temp machines — for rinse chemical only.
2. Remove the plugs from the mixing chamber; and install injection fittings (supplied with your dispenser).
3. A 7/8" detergent injection hole is provided in the back of the wash tank. Remove the S.S. plug and install the detergent fitting (supplied with your dispenser).
4. A 7/8" chemical probe hole is provided in the front of the wash tank heater just below hi limit switch. Insert the probe into the hole from inside the wash tank and secure it with the probe retaining nut provided.

**Note:** Use only commercial-grade detergents and rinse aids recommended by your chemical professional. Do not use detergents and rinse aids formulated for residential dishwashers.

Low Temperatures chemical-sanitizing dishmachines must not exceed 6% sodium hypochlorite solution (bleach) as the sanitizing agent. Higher levels may damage stainless or components.

Follow the directions precisely that are on the litmus paper vial and test the water on the surface of the bottom of the glasses

---

\* Electrical and plumbing connections must be made by qualified person who comply with all available Federal, State, and Local Health, Electrical, Plumbing and Safety codes

2.2.4. Water Tempering Kit (Optional)

**CMA-180, EST-44, EST-66  
WATER TEMPERING VALVE KIT  
P/N 13470.10**

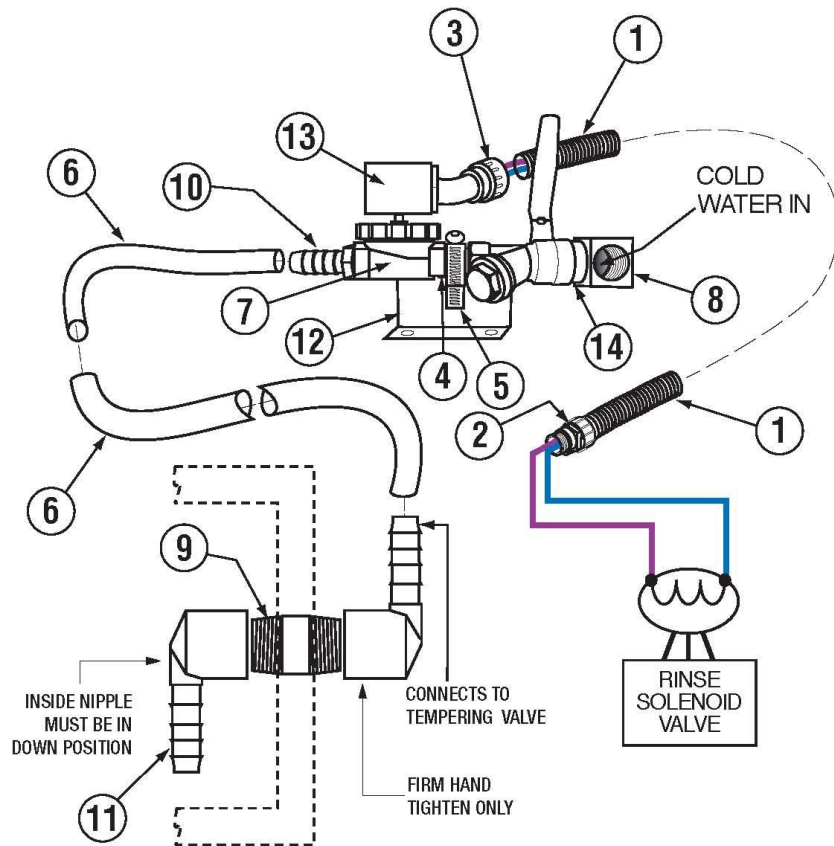

ITEM NO.	P/N	NO REQ'D	DESCRIPTION
1.	00400.00	2	CONDUIT 3/8" SEALTITE
2.	00401.00	1	ST-3/8" STRAIGHT CONNECTOR
3.	00402.00	1	ST-90 DEG 3/8" COONNECTOR
4.	00742.00	1	NIPPLE BRASS 1/2X1-1/2"
5.	03101.00	1	HOSE CLAMP #16 1"
6.	03106.45	5	BRAIDED HOSE 1/2"
7.	03603.15	1	WATER SOLENOID VALVE 1/2"
8.	41030.10	1	1/2" 90 DEG. ELL X F BRASS
9.	13472.00	1	NIPPLE PVC 1/2"X CLOSE
10.	13472.40	1	ADAPTER PVC 1/2" MALE X 1/2" BARB
11.	13472.50	2	ELBOW PVC 90 DEG F X BARB
12.	14508.50	1	PLUMBING BRACKET (180-UC)
13.	00738.15	1	SOLENOID VALVE COIL 220V
14.	41062.00	1	1/2" STRAINER BALL VALVE

2-2013

### 2.2.5. Installation Checklist

- Dishmachine checked for concealed damage.
- Hot water supply is 140° (60°C)
- Cold water supply is 41° (5°C) min
- Incoming water supply lines are ¾”.
- Incoming water supply is 6 gpm minimum capable at 20 psi flow pressure.
- Machine circuit breaker is properly sized.
- Service voltage and phase type are correct to machine data plate.
- High leg of voltage is connected to L2 (three-phase).
- Dishmachine is properly ventilated. Assure minimum clearance for fan is 6”.
- Floor drain plumbing is installed with air gap. **MUST MEET LOCAL CODES.**
- Dishmachine is properly grounded.
- Dishmachine is properly leveled.
- Dishrack guides are adjusted to level of dishtable.
- Machine circuit breaker is labeled D/W
- Water hardness is maximum 3 grains.
- Check that “Ventless” feature is operating properly.

### 2.2.6. Machine Start-Up Procedures

1. Place the scrap baskets over the wash tanks.
2. Secure the wash & rinse arms and check the free-spin.
3. Open the control panel and select ‘normal” toggle switch position.
4. Adjust the rinse pressure using the regulator and the gauge provided on machine.
  - a. Close doors and open the hand-operated fill valve until the water overflows into the scrap trap.
  - b. Turn the power switch to “on” position. *SEE NOTE FOR BOOSTER HEATER BELOW.*
  - c. Press “Auto Fill” switch to activate the water solenoid, adjust the pressure regulator until the gauge reads 20 PSI. *NOTE: Booster heater is filled during this procedure.*

5. Connect the detergent and rinse dispenser to the power block supplied & labeled inside the control panel (208-220) volt.
6. Remove the plug from the mixing chamber and install the rinse injection fitting.
7. A 7/8" chemical probe hole is provided in the wash tank behind wash tank heater cover.
8. A 7/8" detergent fitting hole is provided in the wash tank behind the machine.
9. Check the machine operating temperatures. Adjust if necessary.
  - a. After the machine has warmed up for five to ten minutes (5 – 10 min.), observe the wash and rinse temperatures. The wash temperature must be 155°F minimum. The rinse temperature must be 180°F minimum. If necessary, adjust the temperatures by removing the panel in front of the respective heater and turning the adjustment stem clockwise to increase.

*NOTE: Rinse water temperature must be observed during the rinse cycle.*

10. Check all water and drain fittings for leaks.
11. Install the wall chart and instruct the machine operator on the proper cleaning and operation of the CMA180VL-FL.

The flush-down or cleaning of the condenser is done when the main power switch is turned to the off position.

**Caution: Booster Heater**

***Booster heater is shipped on the dishmachine empty to prevent freezing. When the machine is powered up for the first time, the booster heater must be filled immediately to prevent damage to the heating element. See Section 2.2.7***

***To prevent booster heater element damage, CMA has removed a wire from the high limit switch. When initially filling of a newly installed dishmachine, you must fill the booster tank prior to connecting the removed wire. When water is observed entering the wash tank this indicates the booster tank is full and removed wire can be connected. Failure to follow these important instructions will destroy the heating element because of dry -firing.***

**Warning:**

**The Door Safety Interlock (DSI) is used to prevent the wash cabinet doors from being opened while the dishwasher is in operation. The interlock prevention arm is extended when the wash cycle begins, and remains extended during the duration of the full 60-second wash/rinse cycle including the 110-Second steam evacuation cycle at the very end. Once the full cycle is finished, the door safety interlock arm will be retracted thus allowing the doors to wash cabinet to be opened.**

### 2.2.7. Electrical Requirements

The CMA180VL-FL comes standard factory, wired for 3-phase operation. Check the electrical data plate to confirm this. Refer to "Electrical Requirements" Figure 1-A, for proper wiring instruction for both rectangular booster and wash heaters conversion. Also check the wiring diagram to properly wire the terminal power block, tank heater, and booster heater for 1 phase (or 1B diagram below). Refer to Figure 1-B, for proper wiring instruction for both triangular booster and wash heaters conversion.

#### SINGLE PHASE POWER

**NOTE:** See "Wiring options" section for 1-phase power supply.

Figure 1-A

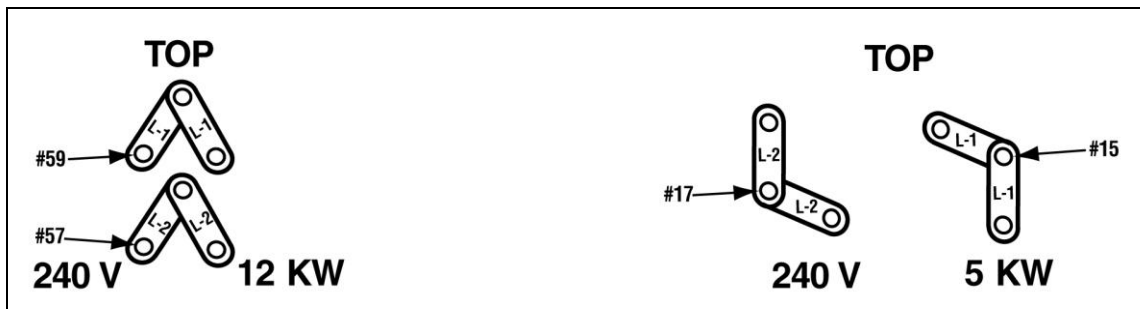
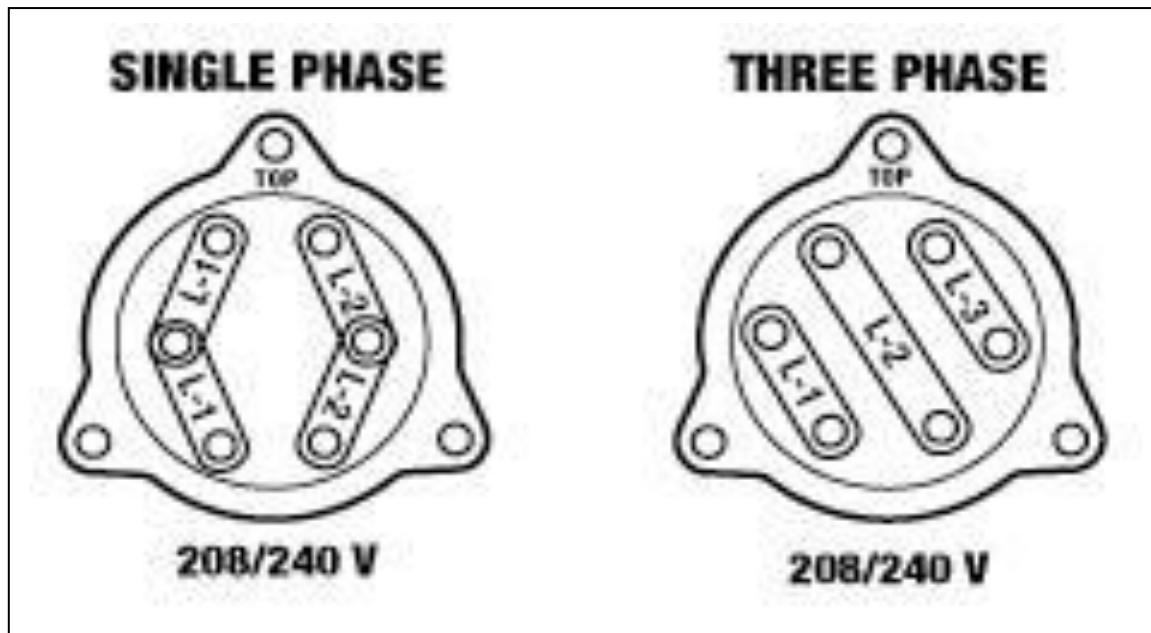

Figure 1-B



### 3. Wiring Options

#### 3-Phase and 1 Phase Wiring Options

Single-Source  
240V 3-Phase  
(Without booster)

Single-Source  
240V 3-Phase  
Standard

Single-Source  
240V 1-Phase

Two-Source  
240V 1-Phase

Single-Source  
240V 1-Phase  
(Without booster)

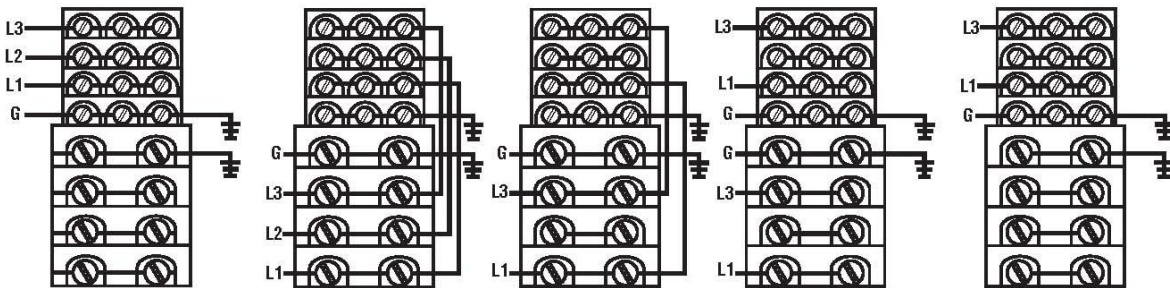

#### DISPENSER HOOK-UP

1. The power signal is 208/230 volts. The power block is labeled inside the control box. Conduit holes for both detergent & rinse are supplied on the control box.
2. A threaded (1/8") injection point is provided on the final rinse Teflon mixing chamber located off the back of the machine.
3. A (7/8") hole is provided in the tank for a probe access. It is located on the front side of the wash tank inside the heater cover.

#### MAIN POWER CONNECTION

Please refer to the machine data plate or choose one of the five (5) power connections illustrated above. Electrical requirements are shown for machines with or without booster heater, three or single phase.

**WARNING:** Insure that the machine is properly grounded and complies with all local and national codes. Injury or death may occur from shock, if the machine is not properly grounded.

Install power supply wires, L1, L2 and L3 (3-Phase) to the appropriate terminals marked L1, L2, and L3 on the power block. (If applicable, the high or "wild" leg must be connected to the L2 Terminal.)

## 4. Quick service guide

### MODEL: CMA 180 VL HIGH TEMP

TECHNICAL ISSUE	CAUSE	SOLUTION
Door mechanical switch problem	Switch alignment issue	Align switch
	Switch button broke	Replace switch,
Pump motor not running	Delimer switch is in <i>OFF</i> position	Flip to <i>NORMAL</i> position
	Loose wire connections	Check and crimp connectors
	Faulty # 3 micro switch in cam timer	Replace micro switch,
	Faulty contactor	Replace contactor,
	Faulty wash pump motor	Replace wash pump motor,
Pump motor runs continuous	Faulty # 3 micro switch in cam timer	Replace micro switch,
	Delimer switch is in <i>DELIME</i> position	Flip to <i>NORMAL</i> position
	Faulty contactor	Replace contactor,
Final rinse water below 180 degree F	Booster heater thermostat not properly set	Adjust thermostat
	Incoming main water temperature below 140 F	Raise water temperature to 140 F
	Tripped or faulty high limit switch	Reset or replace high limit switch,
	Faulty contactor	Replace contactor,
	Faulty booster heater element	Replace heating element,
	Scaled heating element	De- scale heating element
Wash tank heater is not operational	Thermostat is not properly adjusted	Adjust thermostat
	Loose lead connection	Check connectors and secure
	Tripped or faulty high limit switch	Reset or replace high limit switch,
	Faulty float switch	Replace float switch,
	Faulty contactor	Replace contactor,
	Faulty heating element	Replace heating element,
Low water pressure at the final rinse	Water regulator not adjusted properly	Adjust regulator to 18-20 PSI
	Clogged final rinse spray jets	Clean jets
	Missing final rinse spray end cap	Replace end cap,
	Low incoming water pressure from building	Increase pressure
Water solenoid leaks	Scaled or dirty solenoid valve	Clean valve
	Faulty solenoid valve diaphragm	Replace diaphragm,
Wash water temperature too low/high	Thermostat not properly set	Adjust thermostat
	Scaled heating element	Clean scale, delime machine
	Faulty temperature gauge	Replace gauge,
Machine does not operate when the door is closed	Position or proper operation of door switch	Adjust or replace door switch,
	Delimer switch is on <i>OFF</i> position	Flip to <i>NORMAL</i> position
	Faulty 1st micro switch in cam timer	Replace micro switch,
	Check cam timer motor	Replace timer if needed,
	Check ice cube relay	Replace if faulty,
	Faulty wash pump contactor	Replace contactor,
Ventless features not working properly	Check exhaust fan.	Replace if faulty, Assure minimum clearance for is 6"
	Check cam timer setting	Change the setting
	Faulty # 6 micro switch in cam timer	Replace micro switch,

## 5. INITIAL PARTS KIT P/N 1100.17

P/N	DESCRIPTION	NO. REQ'D
00121.18	CMA180 Drain Stopper O Ring	1
00200.10	Pump Assy 110/220V 60 Hz (Open)	1
00206.00	Pump Seal Kit	1
00302.19	CMA180 Buna Gasket (#302.17)	1
00304.17	CMA180 Wash Spray Arm	1
00304.19	CMA180 Rinse Arm W/Bearing	1
00308.17	CMA180 Rinse Arm SS End Plug	1
00308.50	Spray Arm End Plug SS	1
00363.00	Spray Base Lock Pin	1
00404.85	Contactora 208.240V 20AMP	1
00405.00	Start/Fill Switch Toggle	1
00411.00	Micro Switch	1
00421.78	CMA180 Illuminated Plug	1
00421.90	CMA180 Power Switch	1
00475.00	Toggle Switch DPDT 15 AMP/Delimer	1
00501.17	Timer Motor Assy 60 Sec. 220V/60Hz	1
00562.00	Roller Door Switch	1
00602.00	Door Spring	1
00631.05	Ice Cube Relay 220V	1
00706.00	¼ Water Solenoid Repair Kit JE	1
00735.00	¼ Vac Breaker Rep Kit Watts	1
00738.15	¼ Solenoid Coil JE 220V	1
03202.00	Thermometer CMA180 "Wash"	1
03202.00	Thermometer CMA180 "Rinse"	1
03408.55	Counter (Face Mount Sm) 220/50	1
13003.17	Contactora 60 AMP 3 Pole	1
13003.50	Contactora 30 AMP	1
13304.55	SS Final Rinse Spray Jet – HT	1
13415.00	EGO Thermostat Retrofit Kit Rinse	1
13417.47	CMA180 Booster Heater Gasket	1
13422.71	Immersion Heater 12 Kw 3PH/1PH, 240V	1
13417.85	Thermostat Heater CMA-44/CMA-180 Wash	1
13463.10	Liquid Level Switch SS – CMA-44	1
13605.00	Pressure Gauge	1
15518.00	Immersion Heater 6 Kw 3hp/1ph, 240V	1
17523.51	Hi Limit Switch 250 deg	1

**NOTE: CMA recommend that this Model CMA180VL-FL initial parts kit be kept on hand, as a back up supply, in the event your machine should require emergency service. All the parts included in this kit are unique to the CMA180VL-FL dishmachine, and are essential to the "quality" operation and customer service to the CMA180VL-FL unit.**

## 6. Auto-Fill Solid State Timer

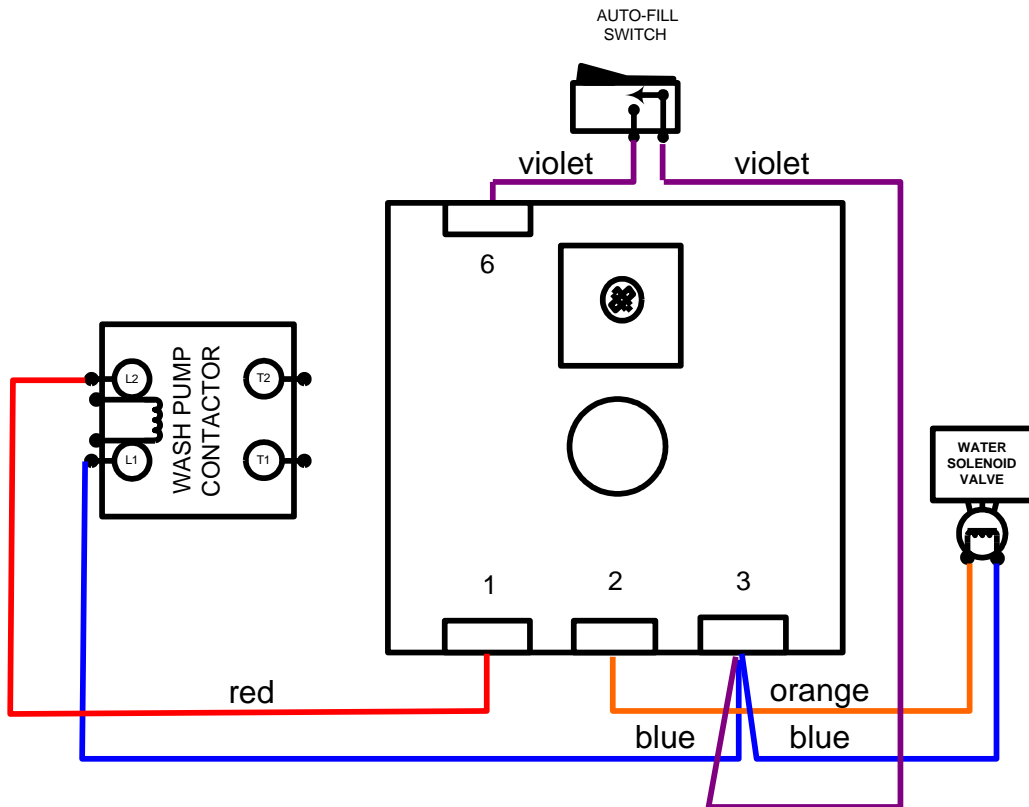
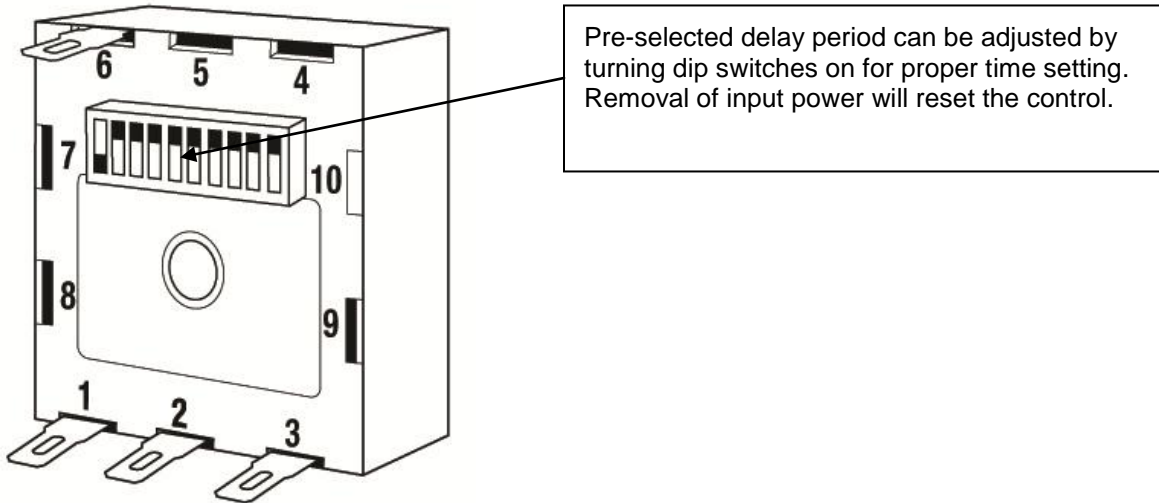

# 7. Wire Diagram CMA180VL-FL 240V

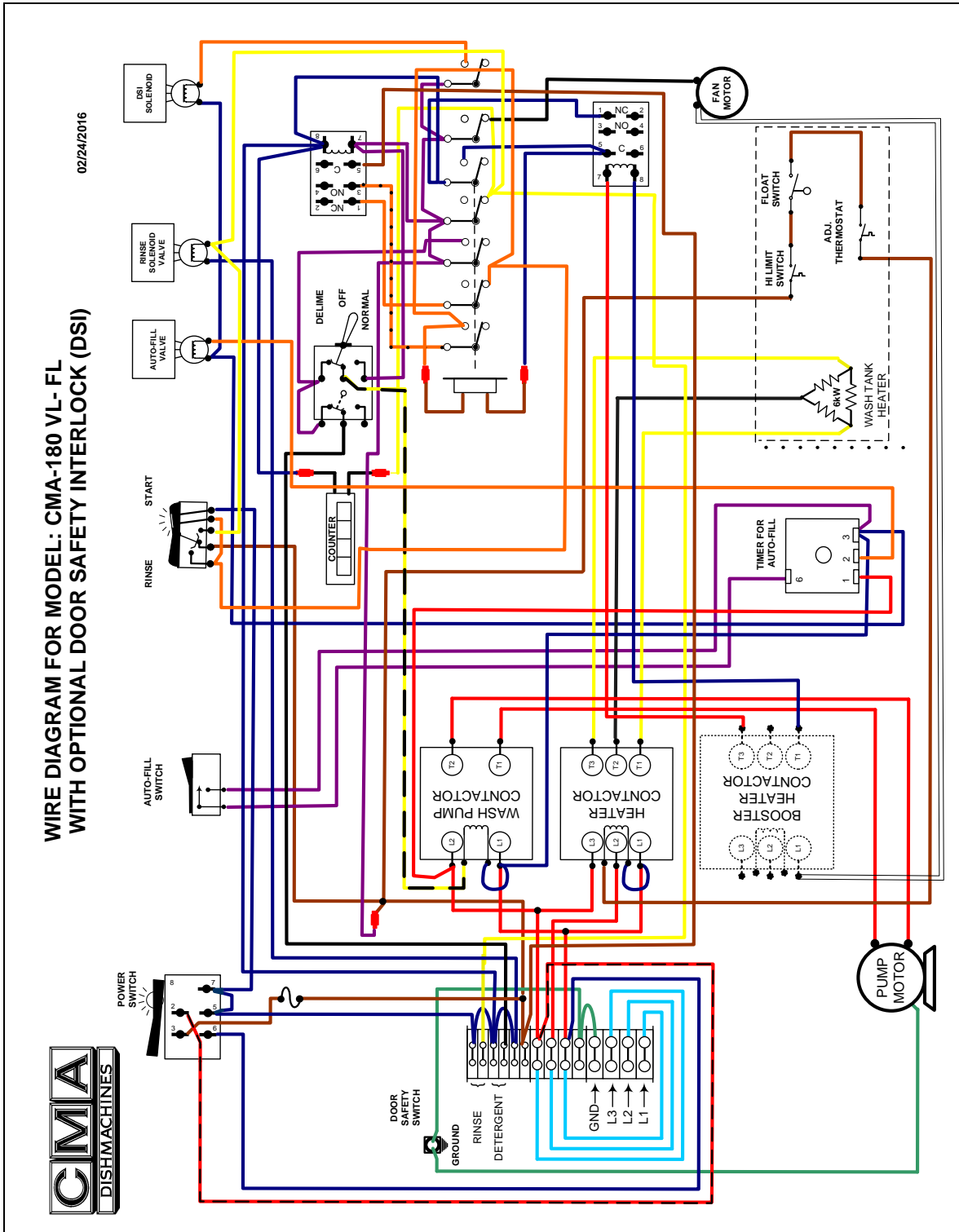

## 8. Wire Diagram CMA180VL-FL 240V Booster Only

