



CARLISLE[®]

FOODSERVICE PRODUCTS

2019-2020

CFSBRANDS®

THE LEADER IN

FoodService Healthcare Janitorial

CFS Brands unites the leading names in foodservice, healthcare and janitorial.

CFS Brands is building the leading platform for light equipment and supplies – bringing professional-grade product solutions to customers around the globe. Our companies include Carlisle FoodService Products, San Jamar, Dinex, Sparta Brush, Marko, Snap Drape and others.

SERVE
PREPARE
PROTECT
DELIVER
DISPENSE
CLEAN



CATALOG GUIDE

-  Dinnerware.....**6-33**
-  Drinkware.....**34-53**
-  Tabletop Accessories**54-67**
-  Marko.....**68-77**
-  Displayware**78-105**
-  Food Bars & Convenience...**106-133**
-  Bar Supplies.....**134-147**
-  Foodservice Trays.....**148-165**
-  Catering Equipment**166-179**
-  Professional Cookware**180-191**
-  Kitchen Accessories**192-213**
-  Storage & Handling**214-233**
-  Warewashing**234-253**
-  Cleaning Tools.....**254-275**
-  Floor & Restroom Care.....**276-311**
-  Transportation**312-321**
-  Waste Management**322-333**
-  Reference/Index/
Terms & Conditions**334-345**

Category Symbols

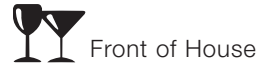

Front of House



Back of House



Sanitary Maintenance



Reference



Index

PROP 65 WARNINGS

APPENDIX A – Bisphenol A (BPA)

 **WARNING:** This product can expose you to chemicals including Bisphenol A (BPA), which is known to the State of California to cause birth defects or other reproductive harm.

For more information go to www.P65Warnings.ca.gov.

APPENDIX B – Di(2-ethylhexylphthalate) (DEHP)

 **WARNING:** This product can expose you to chemicals including Di(2-ethylhexyl)phthalate (DEHP), which is known to the State of California to cause birth defects or other reproductive harm.

For more information go to www.P65Warnings.ca.gov.

APPENDIX C – Styrene

 **WARNING:** This product can expose you to chemicals including Styrene, which is known to the State of California to cause birth defects or other reproductive harm.

For more information go to www.P65Warnings.ca.gov.

| PRODUCT | PAGE | PRODUCT | PAGE | PRODUCT | PAGE |
|---|-------------|--|-------------|--|-------------|
| 21 Key Brushes | 257-259 | Grove | 12 | Hand & Nail | 270 |
| Adapter Bars | 225 | Halcyon | 10 | Handle Guide | 275 |
| Bains Marie | 232 | Leaf | 29, 96 | High Temp | 262 |
| Bakeware | | Melamine Bowls | 30 | Hot Dog Roller | 262 |
| Bake Pans | 188, 190 | Microwave-Ware | 31 | Iron Handle | 265 |
| Cupcake Pans | 190 | Mingle | 11 | Meat Slicer Cleaner | 266 |
| Icing Grates | 191 | Mixing | 209 | Oven & Grill | 268 |
| Muffin Pans | 190 | Octagon | 92 | Pastry | 200-202 |
| Pullman Pans | 190 | Orchid Deli | 91 | Potato | 203 |
| Loaf Pans | 190 | Palette Designer Displayware | 84-85 | Racks | 296 |
| Roast Pans | 188-189 | Palette Displayware Covers | 85 | Radiator | 273 |
| Sheet Pans | 191 | Pebbled | 97 | Scratch | 269 |
| Bar Accessories | 142-147 | Petal Mist | 29, 95 | Spouts, Pumps & Valves | 263 |
| Bar Caddy | 142 | Punch | 104 | Tile & GROUT | 289 |
| Bar Mat & Service Mat | 143 | Rave Displayware | 82 | Toilet Bowl Brush | 309 |
| Bar & Shelf Liner | 143 | Roll-Top Covered | 66 | Toothbrush Style | 266 |
| Barware | | Salad | 30, 87 | Utility Scrubs | 271 |
| Alibi | 36-37 | Salsa | 58 | Vegetable | 203 |
| Lexington Mug | 48 | Scoop | 90 | Vegetable Cutter | 265 |
| Liberty | 44 | Soup | 31 | Wok | 264 |
| Mingle | 38 | Stack | 96 | Bud Vases | 61 |
| Baskets | | Brooms | | Burger Cover | 187 |
| Basket Server | 62 | Angle | 278 | Bus Boxes & Lids | 252-253 |
| Bread & Bun Basket | 63 | Duo-Sweep | 278-279 | Caddies, Condiment & Bar | 131, 141 |
| Munchie Baskets | 62 | Dust Pans | 286 | Cake Covers & Tray | 99 |
| WeaveWear Baskets & Platter | 63 | Floor Sweepers | 286 | Carts | |
| Wicker Look Basket | 63 | Handle Guide | 275 | Bussing/Transport | 316 |
| Woven Baskets | 62 | Lobby Pans | 286 | Dish Dollies | 319-320 |
| Basting Brushes | 200-202 | Lobby Pans & Broom Combos | 285 | Fold 'N Go Carts | 314-315 |
| Beverage Dispensers/Servers | | Natural Corn & Blend | 280 | Janitorial Carts | 321 |
| Cateraide IT | 170 | Racks | 296 | Service Carts | 317 |
| Cateraide LD Series Insulated | 175 | Recycled | 278 | Stainless Steel Carts | 317 |
| Cateraide Slide 'N Seal Insulated | 172 | Straight | 279 | Utility Carts | 318 |
| Cateraide XT Series Insulated | 174 | Synthetic Corn | 281 | Carafes | |
| Round Beverage Dispenser | 132 | Brushes & Scrubs | | 2 Cup | 47 |
| Square Beverage Dispenser | 132 | Atlas Multi-Purpose | 260 | Cascata | 47 |
| TrimLine Rectangular | 132 | Bake Pan Lip | 265 | Charger Plates | 30 |
| Bins, Ingredient | 233 | Basting | 200-202 | Chili & Soup Servers | 177 |
| Booster Seats | 67 | Bottle & Jar | 261 | Cocktail Shakers | 146 |
| Bottle, Oil and Sprayer | 213 | Butcher Block | 266 | Coffee Mugs | 48 |
| Bottle Brushes | 261 | Coffee Service | 263 | Coffee Service | |
| Bottle Holders | 140 | Counter Top | 273 | Cheese Shaker/Sugar Pourer | 60 |
| Bottle Pourers | 144 | Croissant | 200 | Creamer/Pitchers | 60 |
| Bowls | | Cutting Board | 260 | Drip Trays, NeWave | 104 |
| Balsam Display | 80 | Dish | 267 | Sugar Caddies | 60 |
| Bell | 96 | Dishwasher Machine | 264 | Colanders & Strainers | 209 |
| Clam Shells | 96 | Dusters | 274 | Coldmaster Products | |
| Designer Displayware | 89 | Equipment | 264, 266 | CaterCooler | 176 |
| Double Wall Stainless Steel | 98 | Ergonomic Hand Scrubs | 265 | Coldmaster Chillers | 110 |
| Epicure Acacia Wood Grain | 88 | Food Preparation | 203 | Coldmaster Coldcrock & Accessories | 116 |
| Epicure Displayware | 86 | General Clean Up | 72 | Coldmaster Coldpans | 113 |
| Flared Square | 81 | Glass Washing | 261 | Coldmaster Condiment Bar | |
| Gathering | 13 | Grill Bricks | 269 | Organizers | 117 |

| PRODUCT | PAGE | PRODUCT | PAGE | PRODUCT | PAGE |
|---|-------------|--|-------------|--|--------------|
| Coldmaster CoolCheck | 108 | Dinnerware | | Octagonal Crocks | 92 |
| Coldmaster Dispenser | 117 | Dallas Ware | 18-19 | Orchid Deli Bowls | 91 |
| Coldmaster EZ Access Lids | 112 | Dayton | 22-23 | Palette Designer Displayware | 84-85 |
| Coldmaster Ice Cream Server, Shroud & Lid. | 28, 115 | Durus | 14-15 | Pebbled Bowls | 97 |
| Coldmaster Standard Food Pans & Lids | 111 | Epicure | 27 | Petal Mist | 29, 95 |
| Designer Coldmaster | 114 | Gathering | 13 | Rave Displayware | 82 |
| Condiment Bars & Accessories | 117 | Grove | 12 | Rectangular Crocks & Platter | 94 |
| Condiment Caddies | 131, 141 | Halcyon | 10 | Risers | 99 |
| Condiment Organizers | 128 | Kingline | 20-21 | Salad Bowl | 87 |
| Condiment Pumps | 128-129 | Mingle | 11 | Scalloped Platters | 83 |
| Containers | | Polycarbonate, Commercial | 24 | Scalloped DeliWare & Inset | 87 |
| Bains Maries | 232 | Ridge | 9 | Scoop Bowl | 90 |
| Crocks | 118-119 | Sierrus | 16-17 | Stack Bowls | 96 |
| Economical Space Savers | 230 | Square | 26 | Stands | 82 |
| Food Boxes | 226-227 | Stadia | 8 | Terra Displayware | 83 |
| Food Pans | 218-225 | Terra | 25 | Tulip Deli Crocks | 90 |
| Rounds | 231 | Dish Dollies, Optimizer | 319-320 | Disposable Lids | 52-53 |
| Squares | 228-229 | Dish Racks | | Double Boiler | 185 |
| Cookware | | All-Purpose Plate & Tray Rack | 247 | Drain Grates | 224 |
| Braziers | 184 | Combination/Flatware Rack | 246 | Dredges/Powder Cans | 208 |
| Covers | 186-187 | Cup Racks | 247 | Drinkware | 36-46, 48 |
| Double Boiler | 185 | Dollies | 249 | Drip Trays | 104 |
| Fry Pans | 182-183 | Dust Cover | 249 | Dust Pans & Lobby Brushes | 285-286 |
| Mesh Baskets | 187 | Food Pan Rack | 247 | Dusters | 274 |
| Sauce Pans | 185 | Open/Bowl Racks | 246 | End Loaders | |
| Sectional | 185 | Peg Racks | 246 | Cateraide IT | 171 |
| Stock Pots | 184 | Plaque-A-Rack System | 250-251 | Cateraide Slide 'N Seal | 173 |
| Covers | | Rack Cover | 249 | CaterCooler | 176 |
| Burger | 187 | Dishers | 205 | Dollies | 178 |
| Cake | 99 | Dishes, Roll-Top | 66 | Insulated | 176 |
| Compartment Tray | 160 | Dispensers | | Floor Brushes | |
| Cookware | 186-187 | Counter Top Lid & Straw Dispenser | 131 | Dual Surface Brushes | 287 |
| Custom, Plate | 33 | Cup Dispensers | 130 | Handle Guide | 310-311 |
| Display | 99 | Straw Dispenser | 131 | Handles | 293-295 |
| Palette Displayware | 85 | Toothpick Dispenser | 131 | Racks | 296 |
| Pastry Tray | 160 | Display Cases, Pastry | 127 | Scrubs | 287-288 |
| Plate | 32 | Display Cubes | 105 | Swivel Floor Brushes | 288 |
| Creamer | 60 | Displayware | | Tile & Grout Brushes | 289 |
| Crocks | | Balsam | 80 | Floor Maintenance | |
| Classic Crocks | 118 | Bell Bowls | 96 | Boot 'N Shoe Brush | 309 |
| Gourmet | 119 | Clam Shells | 96 | Caution Cones | 307 |
| Octagonal | 92 | Designer Displayware | 89 | Floor Drain Brush | 308 |
| Poly-Tuf | 118 | Double-Wall Stainless Steel Displayware | 98 | Floor Drain Opener | 308 |
| Rectangular | 94 | Epicure Acacia Wood Grain | 88 | Floor Sweepers | 286 |
| Supreme | 119 | Epicure Displayware | 86 | Wet Floor Signs | 307 |
| Tulip Deli | 90 | Flared Square Bowls | 81 | Floor Rack System | 233 |
| Cup Dispensers | 130 | Leaf Bowls | 96 | Floor Squeegees | |
| Dessert Dishes | 28 | MirAcryl Cubes | 105 | Double Foam Squeegees | 289-290 |
| | | Mirrored Trays | 104 | Handle Guide | 275, 310-311 |
| | | Modular Displayware | 93 | Handles | 293-295 |
| | | Narrow Rimmed | 86 | Racks | 296 |
| | | Octagon Bowls | 92 | Rubber Squeegees | 291-292 |
| | | | | VersaClean Brush & Squeegees | 292 |

continued on next page »

| PRODUCT | PAGE | PRODUCT | PAGE | PRODUCT | PAGE |
|---|---------------------------|--|-------------------|---|-------------|
| Floor Sweeps | | Ice Caddies, Cateraide | 179 | Pans, Baking | |
| Omni Sweep | 282 | Ice Cream Server, Shroud | | Bake Pans | 188-189 |
| Fine Floor Sweeps | 283 | & Lid, Coldmaster | 28, 115 | Cupcake Pans | 190 |
| Handle Guide | 275, 310-311 | Ice Only Container | 199 | Icing Grates | 191 |
| Handles | 293-295 | Ice Scoops | 145, 199 | Muffin Pans | 190 |
| Heavy Floor Sweeps | 284 | Ice Sculptures | 103 | Pullman Pans | 190 |
| Medium Floor Sweeps | 283 | Ice Totes, Containers | 199 | Loaf Pans | 190 |
| Multi-Surface Floor Sweeper | 286 | Icing Grates | 191 | Roast Pans | 188-189 |
| Racks | 296 | Ingredient Bins | 233 | Sheet Pans | 191 |
| Sweep Complete | 282 | Insulated Food | | Pasta Cookers, Sectional | 185 |
| Food Bars | | Pan Carriers | 171, 173, 176-177 | Pasta Forks | 121 |
| Adapter Bars | 225 | J-Jars | 61 | Pastry Brushes | 200-202 |
| Buffet Bars | 126 | Janitorial Carts & Accessories | 321 | Pastry Display Cases | 127 |
| Five-Star | 126 | Ladles | 100-101, 121 | Pastry Tray Covers | 160 |
| Maximizer | 122-123 | Lid & Condiment Organizer | 131 | Pitchers | 49-51, 60 |
| Six-Star | 124-125 | Liquor Pourers | 144-145 | Plate Covers | |
| Sneeze Guards | 127 | Lobby Pans | 285-286 | Custom Plate Covers | 33 |
| Tabletop | 124-125 | Measurers | | Polycarbonate Plate Covers | 32 |
| Youth | 124-125 | Commercial | 204 | Polyglass Plate Covers | 32 |
| Food Boxes & Containers | | Dishers | 205 | Plate Stands | 82 |
| Bains Marie | 232 | Measure Misers | 205-207 | Plates | |
| Color-Coded | 226-227 | Measuring Cups | 204 | Charger | 30 |
| Economical Space Saver | 230 | One Gallon Containers | 203 | Epicure Acacia Wood Grain | 88 |
| Food Storage Boxes & Lids | 226-227 | Portioning Cups | 203 | Leaf | 29 |
| Round Containers & Lids | 231 | Microfiber Cloths | 274 | Petal Mist | 29, 95 |
| Square Containers & Lids | 228-229 | Microwave-Ware | 31 | Portable Bar & Accessories | 136-137 |
| Food Pans | | Mixing Bowls | 209 | Powder Cans & Dredges | 208 |
| Coldmaster Food Pans | 113 | Money Maid Combo Packs | 161 | Pump Kit | 128 |
| Drain Grates | 224 | Mop Buckets | 307 | Punch Bowls | 104 |
| Drain Shelves | 220, 222-223 | Mops & Accessories | | Ramekins | |
| DuraPan Food Pans | | Cut-End Mops | 303-304 | Butter Dish | 57 |
| & Accessories | 224-225 | Dust Mops | 298 | Japanese Style | 57 |
| EZ Access Lids | 218, 220-222 | Looped-End Mops | 301-302 | Melamine | 58 |
| High Heat Pans | 218, 222-223 | Microfiber Mops | 297 | Molcajete | 58 |
| Palette Designer Displayware Pans | 84-85 | Microfiber Bucket | 298 | Oval | 56 |
| Polycarbonate Pans | 218, 220 | Mop Bucket & Wringer Combos | 307 | Salsa Dishes | 58 |
| Smart Lids | 219 | Mop Guide | 299-300 | SAN | 59 |
| Specialty Food Pans | 223 | Mop Handles | 297, 304-306 | Sauce Cups | 59 |
| Universal Food Pan Lids | 218 | Screw Top Mops | 304 | Scalloped | 57 |
| Food Preparation Brushes | 203 | Sponge Mops | 305 | Square | 56 |
| Food Stations | 128 | Muffin Pans | 190 | Stainless Steel | 59 |
| French Whips | 212 | Mugs | | Straight Sided | 56 |
| Fry Pans | 182-183 | Coffee | 48 | Rectangular Microfiber Bucket | 298 |
| Fryer Baskets | 187 | Lexington | 48 | Recycle Containers & Lids | 330-331 |
| Glass Rimmers | 144 | Order Racks | 198 | Recycle Lable Kit | 331 |
| Grill Bricks, Screens | 269 | Order Wheels | 198 | Restroom Maintenance | |
| Hand & Nail Brushes | 270 | Oven/Broiler Brushes, Scrapers | 268-269 | Bowl Brushes | 309 |
| Handles & | | Packet Racks | 128 | Force Cup | 309 |
| Accessories | 293-297, 304-306, 310-311 | Paddle Scrapers | 210-211 | Risers | 99 |
| Handle Guide | 275, 310-311 | Pan Carriers | 171, 173, 176-177 | Salad Bars | 122-126 |
| Heat Lamps | 196-197 | | | Salsa Dishes & Bowls | 56-59 |
| Ice Buckets | 147 | | | Sauce Cups | 59 |

| PRODUCT | PAGE | PRODUCT | PAGE | PRODUCT | PAGE |
|--|-------------------|--------------------------------------|-------------------|---|-------------|
| Scoops | 199, 145 | Tortilla Servers | 64-65 | Turners | 216 |
| Scrapers | 210-211 | Tote Boxes & Lids | 252-253 | Vases, Bud | 61 |
| Scrubs, Sponges | 267 | Trays | | Warewashing Racks & Accessories | |
| Service Mat & Bar Mat | 143 | Bakery | 151 | Color-Coded | 240-245 |
| Serving Spoons, Buffet Spoons & Pasta Forks | 100-102, 120-121 | Bar | 162-163 | Customized | 238-239 |
| Servingware | 100-102, 120-121 | Bistro | 157 | Dish | 246-247 |
| Shaker/Dredge | 208 | Café | 157 | Dollies | 249 |
| Shakers, Cocktail | 146 | Cake | 99 | Dust Cover | 249 |
| Sheet Pan Carriers | 177 | Carrier, Insulated | 177 | Flatware | 248 |
| Shelf Liner & Bar Mat | 143 | Celebration, Chrome Plated | 164 | Glass | 240-245 |
| Shovels | 213 | Compartment | 158-160 | Hold Down Grid | 248 |
| Skimmers, Wire Mesh | 209 | Cork | 163 | NeWave | 241 |
| Sneeze Guards | 126-127 | Covers | 160 | OptiClean Rack System | 236-237 |
| Soup & Chili Servers | 177 | Display | 151 | Placque-A-Rack System | 250-251 |
| Soup Service | 31 | Drip | 104 | Rack Cover | 249 |
| Spatulas | 210-211 | Festival | 165 | Specialty | 246-248 |
| Specialty Racks | 246-248 | Fiberglass | 150-156 | Waste Containers | |
| Speed-Rak Bottle Holders | 140 | Glasteel | 150-155 | 50-Gallon Roll Away | 325 |
| Sponges, Scour Pads | 267 | GripLite | 163 | Bronco & Lids | 324-325 |
| Spoons | 100-102, 120-121 | Griptite 2 | 162 | Centurian | 328 |
| Spouts | 144, 263 | Handled | 161 | Compost | 330-331 |
| Spouts, Pumps & Valves | 263 | Illuminated | 103 | Dollies | 326-327 |
| Squeegees | | Low Edge | 151 | Fire Resistant | 329 |
| Floor | 289-292 | Market | 156 | Hot Stamped | 325 |
| Window | 275 | Metric | 151 | Office Wastebaskets | 329 |
| Step Risers | 99 | MirAcryl Mirrored Display | 104 | Recycle Containers & Accessories | 330-331 |
| Store 'N Pour | | Octagonal | 164 | Roll-Away, 50 Gallon | 326 |
| PourPlus | 138 | Oval | 162-164 | Tool Caddy Bag | 325 |
| Complete Units & Backups | 139 | Petal Mist | 95 | TrimLine | 327 |
| Condiment System | 142 | Racks | 247 | Wet Floor Signs | 307 |
| Speed Spout | 138-139 | Rectangular | 151, 157, 162-165 | Whips, French | 212 |
| Bar Service Pack | 139 | Room Service | 161 | Window Maintenance | |
| Strainers & Colanders | 209 | Round | 66, 162-165 | Squeegees | 275 |
| Straw Dispenser | 131 | Stands | 165 | Scrapers | 275 |
| Sugar Caddies | 60 | Tip | 161 | Wine Buckets & Stands | 146 |
| Sugar Pourer/Cheese Shaker | 60 | Trapezoid | 151, 157 | Wine Holder | 147 |
| Syrup Pitchers | 60 | Wrap Trays | 150 | Wine Servers & Coolers | 146-147 |
| Ticket Wheels | 198 | Tulip Dishes | 28 | Wire Mesh Baskets | 187 |
| Tilt Trucks | 332-333 | Tumblers | | Wire Mesh Skimmers | 209 |
| Tip Trays | 161 | Bistro | 42 | Woven Baskets | 62 |
| Tongs | 102, 120-121, 212 | Coca-Cola, Genuine Tumbler | 43 | | |
| Tool Caddy Bag | 325 | Coca-Cola, Stackable | 40 | | |
| Toothpick Dispenser | 131 | Crystalon RimGlow | 45 | | |
| Top Loaders | | Crystalon Stack-All | 42 | | |
| Cateraide IT | 171 | Lafayette | 46 | | |
| Cateraide Slide 'N Seal | 173 | Lorraine | 41 | | |
| CaterCooler | 176 | Mingle | 38 | | |
| Dollies | 178 | Louis | 41 | | |
| Insulated | 177 | Pebble Optic | 43 | | |
| Topping Rails | 129 | Pepsi | 40 | | |
| | | Stackable | 39, 45 | | |
| | | Swirl | 46 | | |



CARLISLE
FOODSERVICE PRODUCTS



ELEGANT VERSATILE DURABLE BEAUTIFUL **DINNERWARE**

Carlisle offers a wide array of guest pleasing dinnerware choices that can coordinate with every type of venue and cuisine. Set your table with Carlisle and watch the savings stack up vs. traditional dinnerware. Our durable collections are designed to be beautiful and long-lasting.



MELAMINE DINNERWARE

Inspired by **classical design and nature**, Stadia blends clean lines with **subtle organic shapes** to delight the eye and add contemporary style to any tabletop. Incorporating **stadium-shaped bowls and coupe plates**, Stadia offers a **refreshing take on traditional design fused with a modern twist** on conventional white dinnerware.



Stadia

- Stadium-shaped bowls and coupe plates with organic shapes offer plating options for any table setting
- Made from heavy-weight melamine resistant to breaking, staining, chipping and cracking
- Look and feel of china without the replacement cost making Stadia a smart investment
- Refreshing neutrals of luminous white and warm grey-beige emphasize food presentation and coordinates with any tabletop décor
- Safe for temperatures up to 212°F
- Dishwasher safe; NSF Listed
- One-year limited warranty



NEW
PRODUCT



| Prod No | Description | Color | Pack |
|--------------------------|------------------------------|--------|-------|
| Stadia Dinnerware | | | |
| 53000 Δ | 10.5" Dinner Plate | 02, 80 | 12 ea |
| 53001 Δ | 9" Salad Plate | 02, 80 | 12 ea |
| 53002 Δ | 7.25" Bread and Butter Plate | 02, 80 | 12 ea |
| 53003 Δ | 8.5" Pasta Plate | 02, 80 | 12 ea |
| 53004 Δ | 9.5" Pasta Plate | 02, 80 | 12 ea |
| 53005 Δ | 11.5" Pasta Plate | 02, 80 | 12 ea |
| 53006 Δ | 12 oz Bowl | 02, 80 | 12 ea |
| 53007 Δ | 32 oz Bowl | 02, 80 | 12 ea |
| 53008 Δ | 52 oz Bowl | 02, 80 | 12 ea |
| 53009 Δ | 13" x 17" Platter | 02, 80 | 12 ea |
| 53010 Δ | 4 oz Sauce Cup | 02, 80 | 24 ea |
| 53011 Δ | 2 oz Sauce Cup | 02, 80 | 24 ea |

NSF Listed products are designated with a Δ and may be prefixed with an N
 Note: Melamine Dinnerware is not recommended for microwave

Inspired by **Earth's natural elements**, our new Ridge collection suggests the **look and texture of stone** with the benefits and **durability of melamine**. Modern, minimalist shapes from bouillon bowls to platters offer a **variety of plating options**.

Ridge

- Neutral & natural colors compliment any plate from ethnic-inspired dishes to farm-to-table culinary creations
- Featuring modern, minimalist organic shapes, premium texture and matte finish
- Ideal where breakage is a concern, such as the poolside
- Durable melamine resists staining, chipping and cracking
- Safe for temperatures up to 212°F
- Dishwasher safe
- One-year limited warranty



| Prod No | Description | Color | Pack |
|-------------------------|--------------------|----------------|-------|
| Ridge Dinnerware | | | |
| 53107 | 10.5" Dinner Plate | 23, 37, 38, 72 | 12 ea |
| 53101 | 10" Coupe Plate | 23, 37, 38, 72 | 12 ea |
| 53106 | 9" Salad Plate | 23, 37, 38, 72 | 12 ea |
| 53105 | 11" Rimless Plate | 23, 37, 38, 72 | 12 ea |
| 53104 | 9" Rimless Plate | 23, 37, 38, 72 | 12 ea |
| 53103 | 18" Oblong Platter | 23, 37, 38, 72 | 6 ea |
| 53102 | 13" Oblong Platter | 23, 37, 38, 72 | 6 ea |
| 53109 | 52 oz Bowl | 23, 37, 38, 72 | 12 ea |
| 53108 | 22 oz Bowl | 23, 37, 38, 72 | 12 ea |
| 53110 | 8 oz Bouillon Bowl | 23, 37, 38, 72 | 24 ea |

Note: Melamine Dinnerware is not recommended for microwave

MELAMINE DINNERWARE

The Halcyon serving ware collection offers perfect plating for a variety of cuisines and food styles. Featuring durable bone-white melamine, Halcyon provides artful plating choices for sushi, salads, pasta, appetizers and more. The collection also includes an assortment of dip bowls, flight trays and spoons. Take your dining and presentation to a new level.

Halcyon

- Unique design enhances the appearance of plated foods
- Made of sturdy, durable, heavy-weight melamine
- Resists oils and staining
- Wide variety including 26 shapes and sizes of plates, platters, serving cups and bowls
- Bone-white is a perfect neutral backdrop for your meal presentation
- Safe for temperatures up to 212°F
- NSF Listed; dishwasher safe
- One-year limited warranty



White(02)

| Prod No | Description | Color | Pack |
|---------------------------|--|-------|-------|
| Halcyon Dinnerware | | | |
| HAL01 Δ | 5", 12 oz Flared Rim Appetizer Cup | 02 | 12 ea |
| HAL02 Δ | 5.5", 18 oz Flared Rim Appetizer Cup | 02 | 12 ea |
| HAL03 Δ | 10", 16 oz Oval Pasta Bowl | 02 | 12 ea |
| HAL04 Δ | 12", 6 oz Round Pasta Bowl | 02 | 12 ea |
| HAL05 Δ | 5", 11 oz Angled Appetizer Cup | 02 | 12 ea |
| HAL06 Δ | 6", 16 oz Angled Appetizer Cup | 02 | 12 ea |
| HAL09 Δ | 9" Square Rim Plate | 02 | 12 ea |
| HAL10 Δ | 10-1/2" Square Rim Plate | 02 | 12 ea |
| HAL11 Δ | 12" Square Rim Plate | 02 | 12 ea |
| HAL12 Δ | 3 Compartment Tray | 02 | 6 ea |
| HAL13 Δ | 7.62 x 7" x 3", 3 oz Small Lily Bowl | 02 | 12 ea |
| HAL14 Δ | 10.5" x 9" x 4.25", 8 oz Medium Lily Bowl | 02 | 12 ea |
| HAL15 Δ | 11.5" x 9.5" x 4.5", 10 oz Large Lily Bowl | 02 | 12 ea |

| Prod No | Description | Color | Pack |
|---------------------------|----------------------------------|-------|-------|
| Halcyon Dinnerware | | | |
| HAL16 Δ | 10" Serving Platter | 02 | 12 ea |
| HAL17 Δ | 11.5" Serving Platter | 02 | 12 ea |
| HAL18 Δ | 13" Serving Platter | 02 | 6 ea |
| HAL20 Δ | 4", 20 oz Petite Sauce Bowl | 02 | 24 ea |
| HAL21 Δ | 4.5", 2 oz Handled Sauce Bowl | 02 | 24 ea |
| HAL22 Δ | 11", 8 oz Top Hat Pasta Bowl | 02 | 12 ea |
| HAL23 Δ | 12", 5 oz Oval Low Bowl | 02 | 12 ea |
| HAL24 Δ | 10.5" x 6.5" Small Serving Plate | 02 | 12 ea |
| HAL26 Δ | 13" x 6.5" Sleigh Tray | 02 | 12 ea |
| HAL27 Δ | .25 oz Pho Spoon | 02 | 48 ea |
| HAL28 Δ | .25 oz Broth Spoon | 02 | 48 ea |
| HAL31 Δ | 2.5", 1 oz Spoon Bowl | 02 | 48 ea |
| HAL32 Δ | 3.5", 2 oz Handled Bowl | 02 | 48 ea |

NSF Listed products are designated with a Δ and may be prefixed with an N
 Note: Melamine Dinnerware is not recommended for microwave

Mingle's swirl design draws attention to the center of the plate – **putting the focus on your culinary creations.**

Mingle

- Perfect for employee dining, pool & resort dining or any casual venue where durability is ideal
- Textured body and swirl design puts the focus on your culinary creations
- Base color mimics ceramics
- Safe for temperatures up to 212°F
- NSF Listed; dishwasher safe
- One-year limited warranty



| Prod No | Description | Color | Pack |
|--------------------------|--------------------------|------------------------|-------|
| Mingle Dinnerware | | | |
| 54001 Δ | 11" Dinner Plate | 13, 15, 17, 18, 46, 52 | 12 ea |
| 54002 Δ | 9" Salad Plate | 13, 15, 17, 18, 46, 52 | 12 ea |
| 54003 Δ | 9", 28.5 oz Rimmed Soup | 13, 15, 17, 18, 46, 52 | 6 ea |
| 54004 Δ | 7", 27 oz Ice Cream Bowl | 13, 15, 17, 18, 46, 52 | 12 ea |
| 54005 Δ | 6", 17 oz Bowl | 13, 15, 17, 18, 46, 52 | 12 ea |
| 54007 Δ | 7" Bread & Butter Plate | 13, 15, 17, 18, 46, 52 | 12 ea |
| 54018 Δ | 5", 4.5 oz Fruit Bowl | 13, 15, 17, 18, 46, 52 | 48 ea |
| 54019 Δ | 8", 35.5 oz Cereal Bowl | 13, 15, 17, 18, 46, 52 | 12 ea |

NSF Listed products are designated with a Δ and may be prefixed with an N
 Note: Melamine Dinnerware is not recommended for microwave

MELAMINE DINNERWARE

Grove features **classic shapes with unique features and patterns.**

For **use inside and out**; dress up a table for everyday entertaining or use worry-free **for school, church, parties, poolside or barbecues.**

Grove

- Temperature insulated; resists drawing heat or cold away from food
- Durable, heavy-weight melamine with the look of stoneware resists chipping and breakage
- Mix and match Grove's complimentary neutral colors or pair with traditional solid pieces from other collections
- Gently stroped design imitates the look of weathered wood and lends itself to standardized plating
- One-year limited warranty against breakage
- Safe for temperatures up to 212°F
- Dishwasher safe; NSF listed



| Prod No | Description | Color | Pack |
|-------------------------|-----------------------------------|----------------------|-------|
| Grove Dinnerware | | | |
| 64001 Δ | 11" Dinner Plate | 06, 15*, 18, 46, 70 | 12 ea |
| 64002 Δ | 9" Salad Plate | 06, 15, 18, 46, 70 | 12 ea |
| 64007 Δ | 7" Bread & Butter Plate | 06, 15, 18, 46, 70 | 12 ea |
| 64020 Δ | 12" x 8" Oval Plate | 06*, 15, 18, 46, 70 | 12 ea |
| 64022 Δ | 10.5" x 10.5" Square Dinner Plate | 06, 15, 18, 46, 70 | 12 ea |
| 64023 Δ | 8.5" x 8.5" Square Salad Plate | 06, 15, 18, 46*, 70* | 12 ea |
| 64003 Δ | 9", 28.5 oz Soup Bowl | 06, 15, 18, 46, 70 | 6 ea |
| 64005 Δ | 6", 17 oz Small Bowl | 06, 15, 18, 46*, 70 | 12 ea |
| 64013 Δ | 7", 27 oz Ice Cream Bowl | 06*, 15, 18, 46, 70 | 12 ea |
| 64018 Δ | 5", 4.5 oz Fruit Bowl | 06, 15, 18, 46, 70 | 48 ea |

NSF Listed products are designated with a Δ and may be prefixed with an N

Note: Melamine Dinnerware is not recommended for microwave

* Color available by special order only

Gathering has an organic **look of beautiful hand-thrown pottery** with the lasting time-tested **durability and weight of melamine**. Gathering designs feature **larger plating surfaces**. **Texture and color complete the mood** in a variety of dining settings.

Gathering

- The modern European coupe design is on-trend and offers larger plating surfaces
- The unique look fits perfectly within the farm-to-table setting
- Heavy-weight melamine is dishwasher safe and stain resistant making Gathering a great investment
- Safe for temperatures up to 212°F
- One-year limited warranty against breakage
- NSF Listed



Adobe(70)

| Prod No | Description | Color | Pack |
|-----------------------------|-------------------------|-------|-------|
| Gathering Dinnerware | | | |
| GA55001 Δ | 11" Dinner Plate | 70 | 12 ea |
| GA55002 Δ | 9" Salad Plate | 70 | 12 ea |
| GA55008 Δ | 7" Bread & Butter Plate | 70 | 12 ea |
| GA55003 Δ | 8", 35.5 oz Small Bowl | 70 | 12 ea |
| GA55011 Δ | 6", 20 oz Small Bowl | 70 | 12 ea |
| GA55012 Δ | 4.62", 9 oz Dip Bowl | 70 | 12 ea |
| GA55013 Δ | 12.5" Charger Plate | 70 | 12 ea |
| GA55014 Δ | 12" x 8" Oval Platter | 70 | 12 ea |

NSF Listed products are designated with a **Δ** and may be prefixed with an N

Note: Melamine Dinnerware is not recommended for microwave

MELAMINE DINNERWARE

Durus looks and feels like porcelain dinnerware without the replacement costs due to chipping or breaking. **Switch to Durus and watch the savings pile up!**

Durus®

- High quality, heavy-weight melamine dinnerware has the look and feel of china without the replacement cost
- Available in 9 solid colors
- Minimize your scratch and stain problems with our exclusive mirror-like glaze
- See a return on investment in less than 18 months in most operations after switching to Durus from china
- Reduce dinnerware drying time with the advanced Durus foot design and slick water-sheeting glazed surface
- Save money with our Durus four-year warranty* against breakage, the best guarantee in the industry
- Mix and match Durus side dishes with china plates for a beautiful tabletop that costs less to maintain
- Custom decorating available; see page 334
- Safe for temperatures up to 212°F
- Four-year limited warranty
- NSF Listed; dishwasher safe



Coordinating Ramekins & Soup Bowls are also shown below. Additional information on coordinating pieces can be found in the Drinkware & Tabletop Accessories catalog sections.



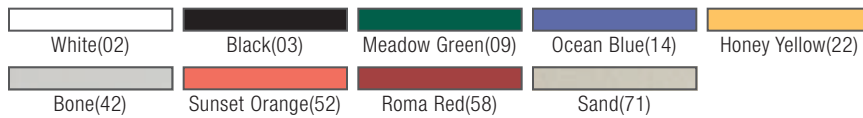

| Prod No | Description | Color | Pack |
|--------------------------------|------------------------------------|------------------------------------|-------|
| Durus Narrow Rim Plates | | | |
| 43000 Δ | 10.5" 3-Compartment Plate | 42 | 12 ea |
| 43002 Δ | 10.5" Dinner Plate | 02, 09, 14, 22, 42, 52 | 12 ea |
| 43004 Δ | 9" Dinner Plate | 02, 09, 14, 22, 42, 52, 58, 71 | 24 ea |
| 43006 Δ | 7.25" Salad Plate | 02, 09, 14, 22, 42, 52 | 48 ea |
| 43008 Δ | 6.5" Pie Plate | 02, 03, 09, 14, 22, 42, 52, 71 | 48 ea |
| Durus Wide Rim Plates | | | |
| 43024 Δ | 12" Dinner Plate | 02 | 12 ea |
| 43010 Δ | 10.5" Dinner Plate | 02, 14, 22, 42, 52* | 12 ea |
| 43012 Δ | 9" Dinner Plate | 02, 09, 14, 22, 42, 52 | 24 ea |
| 43016 Δ | 7.5" Salad Plate | 02 | 48 ea |
| 43018 Δ | 6.5" Pie Plate | 02, 14, 42 | 48 ea |
| Durus Oval Platters | | | |
| 43080 Δ | 13.5" x 10.5" Oval Platter | 02, 09, 14, 22*, 42, 52, 71 | 12 ea |
| 43082 Δ | 12" x 9.25" Oval Platter | 02, 03, 09, 14, 22, 42, 52, 58, 71 | 12 ea |
| 43086 Δ | 9.5" x 7.25" Oval Platter | 02, 03, 22*, 42, 52* | 24 ea |
| Durus Bowls & Cup | | | |
| 43030 Δ | 20 oz, 12" Chef Salad/Pasta Bowl | 02, 03, 09, 14, 22, 42, 52, 58 | 12 ea |
| 43032 Δ | 16 oz, 7.5" Rimmed Bowl | 02, 03, 14, 22, 52 | 24 ea |
| 43034 Δ | 13 oz, 9.25" Pasta/Soup/Salad Bowl | 02, 09*, 14, 22, 42, 52*, 58 | 24 ea |
| 43036 Δ | 12 oz, 7.25" Rimmed Bowl | 02, 09, 14, 22, 42, 52, 71 | 24 ea |
| 43038 Δ | 10 oz, 5.38" Rimmed Nappie Bowl | 02, 09, 14, 22, 42, 52 | 24 ea |
| 43040 Δ | 6 oz, 6" Rimmed Bowl | 02, 09, 14, 22, 42, 52 | 48 ea |
| 43042 Δ | 4.5 oz, 4.75" Rimmed Fruit Bowl | 02, 09, 14, 22, 42, 52, 58, 71 | 48 ea |
| 43050 Δ | 7 oz, 4" Bouillon Cup | 02, 03, 09, 14, 22, 42, 52, 71 | 48 ea |

NSF Listed products are designated with a Δ and may be prefixed with an N

Note: Melamine Dinnerware is not recommended for microwave

* Color available by special order only



MELAMINE DINNERWARE

Dress your dining table with the **beauty and feel of porcelain** at a fraction of the price. Sierrus Dinnerware is a **medium weight** version of our popular Durus design. Mix and match Durus with Sierrus to make your budget go farther.

Sierrus™

- All purpose, medium-heavy weight dinnerware has the same design as our Durus® line
- Available in eight solid colors
- Made of heavy-duty, break-resistant melamine
- Safe for temperatures up to 212°F
- Two-year limited warranty
- NSF Listed; dishwasher safe

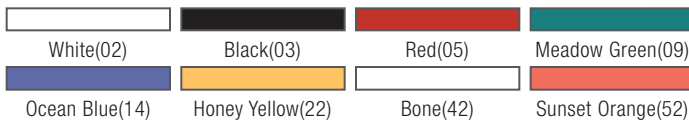

| Prod No | Description | Color | Pack |
|----------------------------------|---------------------------|-----------------------------------|-------|
| Sierrus Narrow Rim Plates | | | |
| 33000 Δ | 10.5" 3-Compartment Plate | 02, 03, 05, 09, 14, 22, 42, 52 | 12 ea |
| 33002 Δ | 10.5" Dinner Plate | 02, 03, 05, 09, 22, 42, 52 | 12 ea |
| 33004 Δ | 9" Dinner Plate | 02, 03, 05, 09, 14, 22, 42, 52 | 24 ea |
| 33006 Δ | 7.25" Salad Plate | 02, 03, 05, 09, 14, 22, 42, 52* | 48 ea |
| 33008 Δ | 6.5" Pie Plate | 02, 03, 05, 09*, 14, 22*, 42, 52 | 48 ea |
| Sierrus Wide Rim Plates | | | |
| 33024 Δ | 12" Dinner Plate | 02, 03, 05, 09*, 14, 42, 52* | 12 ea |
| 33010 Δ | 10.5" Dinner Plate | 02, 05*, 09*, 14*, 22, 42, 52* | 12 ea |
| 33012 Δ | 9" Dinner Plate | 02, 03, 05, 09, 14, 22, 42, 52 | 24 ea |
| 33016 Δ | 7.5" Salad Plate | 02, 05, 09*, 14, 22*, 42, 52 | 48 ea |
| 33018 Δ | 6.5" Pie Plate | 02, 03, 05*, 09, 14*, 22, 42, 52* | 48 ea |
| 33020 Δ | 5.5" Bread & Butter Plate | 02, 03*, 05, 09, 14, 42, 52* | 48 ea |

NSF Listed products are designated with a Δ and may be prefixed with an N

Note: Melamine Dinnerware is not recommended for microwave

* Color available by special order only



Carlisle Mugs

Carlisle Mugs pair perfectly with the color options of Sierrus Dinnerware.

See page 48 for more information on these great mugs.

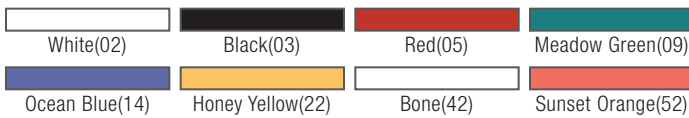

| Prod No | Description | Color | Pack |
|--------------------------------|------------------------------------|----------------------------------|-------|
| Sierrus Platters | | | |
| 33080 Δ | 13.5" x 10.5" Oval Platter | 02, 03, 05, 09, 14, 22, 42, 52* | 12 ea |
| 33082 Δ | 12" x 9.25" Oval Platter | 02, 03, 05, 09, 14, 22, 42, 52 | 12 ea |
| 33086 Δ | 9.5" x 7.25" Oval Platter | 02, 03, 05, 09*, 14, 22, 42, 52* | 24 ea |
| Sierrus Bowls & Cup | | | |
| 33030 Δ | 20 oz, 12" Chef Salad/Pasta Bowl | 02, 03, 05, 14, 22, 42, 52* | 12 ea |
| 33032 Δ | 16 oz, 7.5" Rimmed Bowl | 02, 03, 05, 09, 14, 22, 42, 52* | 24 ea |
| 33034 Δ | 13 oz, 9.25" Pasta/Soup/Salad Bowl | 02, 03, 05, 09*, 14, 22, 42 | 24 ea |
| 33036 Δ | 12 oz, 7.25" Rimmed Bowl | 02, 03, 05, 09, 14, 22, 42, 52 | 24 ea |
| 33038 Δ | 10 oz, 5.38" Rimmed Nappie Bowl | 02, 03, 05, 09*, 14, 22, 42, 52 | 24 ea |
| 33040 Δ | 6 oz, 6" Rimmed Bowl | 02, 03, 05, 09, 14, 22, 42, 52 | 48 ea |
| 33042 Δ | 4.5 oz, 4.75" Rimmed Fruit Bowl | 02, 03, 05, 09, 14, 22, 42, 52 | 48 ea |

NSF Listed products are designated with a Δ and may be prefixed with an N

Note: Melamine Dinnerware is not recommended for microwave

* Color available by special order only

MELAMINE DINNERWARE

Dallas Ware set the industry standards by which all others are judged. **Quality and durability have been the Dallas Ware trademark for over 50 years.** The NSF listing on all Dallas Ware items ensures the highest sanitary standards.

Dallas Ware®

- Reinforced rim and foot design stacks with major competitors' products
- Meets PS25-70 specifications
- Safe for temperatures up to 212°F
- One-year limited warranty
- NSF Listed; dishwasher safe

Tabletop Accessories available in coordinating colors. See page 58 for more details





| | | | | |
|------------------|-----------|---------------|------------------|-------------------|
| White(02) | Black(03) | Red(05) | Meadow Green(09) | Ocean Blue(14) |
| Honey Yellow(22) | Tan(25) | Café Blue(35) | Bone(42) | Sunset Orange(52) |

Prod No **Description** **Color** **Pack**

Dallas Ware Narrow Rim Plates

| | | | |
|---------|----------------------------|--|-------|
| 43500 Δ | 10.25" Dinner Plate | 02, 03, 05, 09, 14, 22, 25, 35, 42, 52 | 48 ea |
| 43501 Δ | 9" Dinner Plate | 02, 03, 05, 09, 14, 22, 25, 35, 42, 52 | 48 ea |
| 43503 Δ | 7.25" Salad Plate | 02, 03, 05, 09, 14, 22, 25, 35, 42, 52 | 48 ea |
| 43504 Δ | 6.5" Pie Plate | 02, 25 | 48 ea |
| 43505 Δ | 5.63" Bread & Butter Plate | 02, 25, 35 | 48 ea |

Dallas Ware Compartment Plates

| | | | |
|---------|----------------------------------|--------|-------|
| 43512 Δ | 11", 1" D, 3-Compartment Plate | 35 | 48 ea |
| 43514 Δ | 9.75", 1" D, 3-Compartment Plate | 25, 35 | 36 ea |
| 43516 Δ | 9", 1.31" D, 3-Compartment Plate | 02, 25 | 24 ea |

Dallas Ware Oval Platters

| | | | |
|---------|----------------------------|--------------------|-------|
| 43560 Δ | 12" x 8.5" Oval Platter | 02, 03, 25, 35 | 24 ea |
| 43563 Δ | 9.25" x 6.25" Oval Platter | 02, 03, 25, 35, 42 | 24 ea |

Dallas Ware Bowls

| | | | |
|---------|------------------------------|--|-------|
| 43520 Δ | 16 oz, 5.75" Nappie Bowl | 02, 25 | 48 ea |
| 43521 Δ | 14 oz, 5.5" Nappie Bowl | 02, 03, 05, 09, 14, 22, 25, 35, 42, 52 | 48 ea |
| 43522 Δ | 14 oz, 5.5" Rim Nappie Bowl | 02, 25, 35 | 24 ea |
| 43525 Δ | 13 oz, 5.25" Nappie Bowl | 02, 25, 35 | 24 ea |
| 43528 Δ | 10 oz, 5" Nappie Bowl | 02, 25, 35 | 48 ea |
| 43529 Δ | 10 oz, 5.88" Grapefruit Bowl | 02, 03, 05, 09, 14, 22, 25, 35, 42*, 52* | 48 ea |
| 43531 Δ | 4.75 oz, 4.5" Fruit Bowl | 02, 25, 35 | 48 ea |
| 43532 Δ | 3.5 oz, 4.13" Fruit Bowl | 02, 03, 05, 25, 35 | 48 ea |
| 43533 Δ | 6.5 oz Oval Fruit Dish | 02 | 48 ea |
| 43540 Δ | 8 oz, 3.75" Bouillon Cup | 02, 03, 05, 09, 14, 22, 25, 35, 42, 52 | 24 ea |

NSF Listed products are designated with a Δ and may be prefixed with an N

Note: Melamine Dinnerware is not recommended for microwave

* Color available by special order only



MELAMINE DINNERWARE

Kingline is the top choice for **heavy-duty applications like school cafeterias.** Our medium weight melamine offers **beauty and durability at a great value.**

Kingline™

- All purpose, medium weight dinnerware meets the tough requirements of heavy-duty foodservice applications
- Durable gloss finish resists chipping, scratching and staining
- Reinforced at vital stress points
- Save even more money with our exclusive Sandshades® variegated dinnerware
- Safe for temperatures up to 212°F
- One-year limited warranty
- NSF Listed; dishwasher safe

TOP CHOICE FOR SCHOOLS



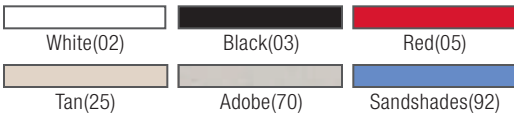

| Prod No | Description | Color | Pack |
|------------------------------------|-------------------------------------|----------------------|-------|
| Kingline Plates | | | |
| KL116 Δ | 10" Dinner Plate | 02, 03, 25 | 48 ea |
| KL200 Δ | 9" Dinner Plate | 02, 03, 05, 25, 70 | 48 ea |
| KL920 Δ | 9" Dinner Plate | 92 | 48 ea |
| KL201 Δ | 7.25" Sandwich Plate | 02, 03, 05, 25 | 48 ea |
| KL204 Δ | 6.5" Pie Plate | 02, 03, 05, 25 | 48 ea |
| KL205 Δ | 5.5" Bread & Butter Plate | 02, 25, 70 | 48 ea |
| Kingline Compartment Plates | | | |
| KL102 Δ | 10", .75" D, 3-Compartment Plate | 02, 25, 70 | 48 ea |
| KL203 Δ | 8.75", 1.25" D, 3-Compartment Plate | 02, 25 | 12 ea |
| Kingline Oval Platters | | | |
| KL126 Δ | 13.5" x 9.75" Oval Platter | 02, 25 | 12 ea |
| KL127 Δ | 12" x 9" Oval Platter | 02, 03, 05, 25, 70** | 12 ea |
| Kingline Bowls & Cup | | | |
| KL350 Δ | 8 oz Bouillon Cup | 02, 03, 05, 25 | 48 ea |
| KL115 Δ | 16 oz, 6.13" Chowder Bowl | 02, 25 | 48 ea |
| KL108 Δ | 14 oz, 5.5" Nappie Bowl | 02, 25 | 48 ea |
| KL119 Δ | 12.5 oz, 5.5" Rimmed Nappie Bowl | 02, 25 | 48 ea |
| KL924 Δ | 12.5 oz, 5.5" Rimmed Nappie Bowl | 92 | 48 ea |
| KL121 Δ | 10 oz, 5.88" Grapefruit Bowl | 02, 25 | 48 ea |
| KL118 Δ | 10 oz, 5.13" Nappie Bowl | 02, 03, 05, 25 | 48 ea |
| KL123 Δ | 8 oz, 7.75" Wide Rimmed Salad Bowl | 02 | 48 ea |
| KL800 Δ | 5 oz, 5" Rimmed Fruit Bowl | 02, 25, 70 | 48 ea |
| KL805 Δ | 4.75 oz, 4.5" Rimmed Fruit Bowl | 02, 03, 05, 25 | 48 ea |
| KL928 Δ | 4.75 oz, 4.25" Rimmed Fruit Bowl | 92 | 48 ea |

NSF Listed products are designated with a Δ and may be prefixed with an N

Note: Melamine Dinnerware is not recommended for microwave

*Sandshades items vary in color, hue and intensity from piece to piece

** Color available by special order only

MELAMINE DINNERWARE

With **versatility and strength** on its side, Dayton continues to be a reliable dinnerware choice. **Modern colors** bring life to the table while the **look of ceramic** maintains a classic feel. **Mix and match with Dallas Ware** to acquire a truly customized setting.

Dayton™

- Withstands the rigors of commercial foodservice dishwasher use
- Maintains its appearance after one year of dishwasher testing
- Dayton melamine is stain-, scratch- and break-resistant, making it ideal for any foodservice operation
- Safe for temperatures up to 212°F
- One-year limited warranty

43866



43864



43850

43850

43868

43856

43858

43872

43866

43860

43862

43850

43864

43854

10 GREAT COLORS

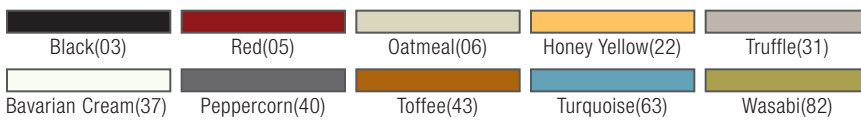

| Prod No | Description | Color | Pack |
|--|------------------------------|---|-------|
| Dayton Dinnerware Plates & Platters | | | |
| 43850 | 10.25" Dinner Plate | 03, 05, 22, 31*, 37, 40*, 43*, 63, 82 | 48 ea |
| 43852 | 9" Dinner Plate | 03, 05, 06, 22, 31, 37, 40, 43*, 63, 82 | 48 ea |
| 43854 | 7.25" Salad Plate | 03*, 05, 06*, 22, 37*, 63 | 48 ea |
| 43856 | 5.63" Bread & Butter Plate | 03, 05, 06, 22, 37, 63*, 82* | 48 ea |
| 43872 | 9.25" x 6.25" Oval Platter | 05, 37 | 24 ea |
| Dayton Dinnerware Bowls & Cup | | | |
| 43858 | 16 oz, 5.75" Nappie Bowl | 03, 05, 06*, 22*, 37, 63*, 82* | 48 ea |
| 43860 | 14 oz, 5.5" Rim Nappie Bowl | 03, 05, 06, 22*, 31*, 37, 40, 63, 82 | 24 ea |
| 43862 | 10 oz, 5" Nappie Bowl | 03, 05, 06*, 22, 37, 43*, 82* | 48 ea |
| 43864 | 10 oz, 5.88" Grapefruit Bowl | 03, 05, 06*, 22, 31, 37, 43*, 63*, 82 | 48 ea |
| 43866 | 4.75 oz, 4.5" Fruit Bowl | 03, 05, 06, 22, 31*, 37*, 40*, 63, 82* | 48 ea |
| 43868 | 8 oz, 3.75" Bouillon Cup | 03, 05, 06*, 22*, 31*, 37, 40*, 43*, 63*, 82* | 24 ea |

Note: Melamine Dinnerware is not recommended for microwave
* Color available by special order only

COMMERCIAL DINNERWARE

Polycarbonate material resists stains and chipping

- Designed for corrections, hospitals, schools, long term care facilities, or anywhere long product life and economy are important
- Super-tough polycarbonate dinnerware offers a five-year guarantee against breakage
- Plates have scratch-resistant textured surface
- Stacks with other polycarbonate dinnerware currently on the market
- Temperature use range: -40° to 212°F
- Five-year limited warranty
- NSF Listed; dishwasher safe

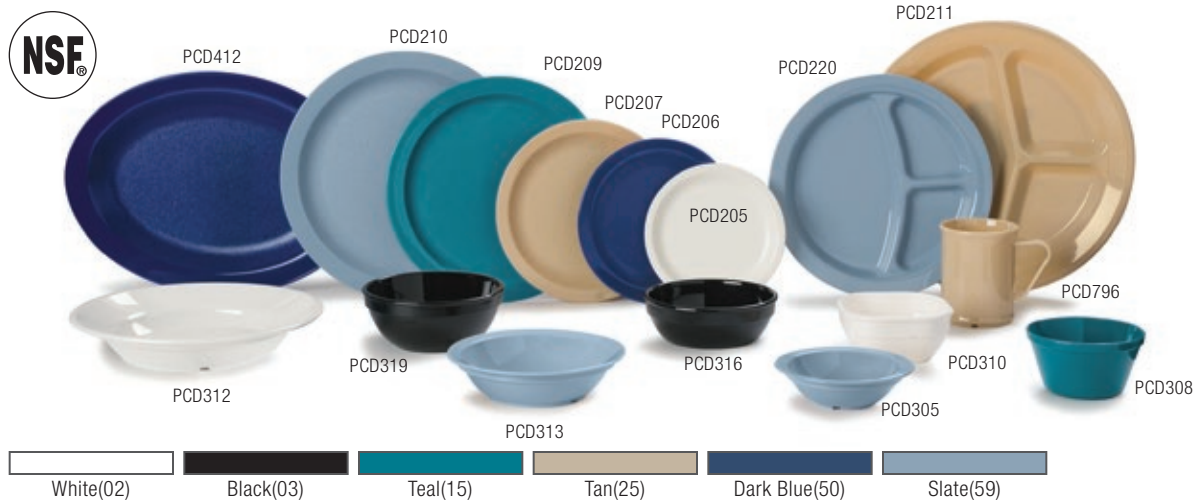

| Prod No | Description | Color | Pack |
|---|--|------------------------|-------|
| Commercial Dinnerware Plates | | | |
| PCD210 ▲ | 10" Narrow Rim Plate | 02, 03, 25, 50, 59 | 48 ea |
| PCD209 ▲ | 9" Narrow Rim Plate | 02, 03, 15, 25, 50, 59 | 48 ea |
| PCD207 ▲ | 7.25" Narrow Rim Plate | 25 | 48 ea |
| PCD206 ▲ | 6.5" Narrow Rim Plate | 02, 03, 50, 59 | 48 ea |
| PCD205 ▲ | 5.5" Narrow Rim Plate | 02, 03 | 48 ea |
| Commercial Dinnerware Compartment Plates | | | |
| PCD211 ▲ | 11" Narrow Rim 3-Compartment Plate, 1.25" deep | 03, 25 | 48 ea |
| PCD220 ▲ | 9" Narrow Rim 3-Compartment Plate, 1" deep | 02, 59 | 48 ea |
| Commercial Dinnerware Oval Platter | | | |
| PCD412 ▲ | 12" x 9" Oval Platter | 02, 03, 50 | 24 ea |
| Commercial Dinnerware Bowls & Cup | | | |
| PCD319 ▲ | 15 oz, 5.25" Nappie Bowl | 02, 03, 25, 50 | 48 ea |
| PCD312 ▲ | 12 oz, 9" Soup Bowl | 02, 03 | 48 ea |
| PCD310 ▲ | 10 oz, 4" Square Bowl | 02 | 48 ea |
| PCD313 ▲ | 10 oz, 6" Rimmed Grapefruit Bowl | 02, 59, 25 | 48 ea |
| PCD316 ▲ | 10 oz, 5" Nappie Bowl | 03 | 48 ea |
| PCD308 ▲ | 8.4 oz, 4" Bouillon Cup | 02, 15 | 48 ea |
| PCD305 ▲ | 5 oz, 3.5" Rimmed Fruit Bowl | 02, 03, 15, 25, 50, 59 | 48 ea |
| Commercial Dinnerware Mug | | | |
| PCD796 ▲ | 9.6 oz Mug | 02, 25 | 48 ea |

NSF Listed products are designated with a ▲ and may be prefixed with an N
 ◆ California Residents: Bisphenol A **WARNING:** See appendix A on page 1

DINNERWARE ACCENT PIECES

Terra Dinnerware Accents offer the exotic and earthy look of **hand thrown pottery** with the break resistance of heavy duty melamine. The **organic design** blends in with many food presentations and styles.

Terra™

- The look of heavy-weight, hand thrown pottery blends into a variety of settings and offers an exceptional presentation
- Constructed of a unique, break-resistant material with the look and feel of ceramic
- Safe for temperatures up to 212°F
- One-year limited warranty
- NSF Listed; dishwasher safe



| Prod No | Description | Color | Pack |
|-------------------------|-------------------------------------|--------|-------|
| Terra Dinnerware | | | |
| 43410 Δ | 9" Terra Square Plate | 02 | 24 ea |
| 43420 Δ | 58 oz, 9.75" Terra Footed Bowl Pack | 02, 03 | 12 ea |
| 43422 Δ | 40 oz, 8.5" Terra Footed Bowl | 02, 03 | 12 ea |

NSF Listed products are designated with a Δ and may be prefixed with an N

DINNERWARE ACCENT PIECES

Square

As a tasting plate, an accent dish or the foundation for a grand buffet, square plates are on trend. Our square plates have rounded edges and the fine look of porcelain.

- Squares offer the look of ceramics in long-wearing melamine
- Three sizes hold everything from salads and appetizers to buffet style presentations
- Squared rim design is a sleek take on a classic look
- Made of heavy-duty, break-resistant melamine
- Safe for temperatures up to 212°F
- One-year limited warranty
- NSF Listed; dishwasher safe

Square Scoops

- Scoop shaped design holds sauces as well as appetizers or side dishes



| Prod No | Description | Color | Pack |
|--------------------------|-------------------------------|--------|-------|
| Square Dinnerware | | | |
| 43308 Δ | 8" Square Plate | 02,03 | 48 ea |
| 43306 Δ | 9.5" Square Plate | 02,03 | 48 ea |
| 43304 Δ | 11.5" Square Plate | 02,03 | 48 ea |
| Square Scoops | | | |
| 7940 Δ | 2 oz, 3.5" Small Square Dish | 02 | 48 ea |
| 7942 Δ | 5 oz, 5.25" Small Square Dish | 02, 03 | 48 ea |

NSF Listed products are designated with a Δ and may be prefixed with an N

Epicure®

The elegant coupe shape is the perfect frame for larger plating creations. Epicure's coupe shape lends European appeal in durable melamine.

- European coupe design combines strength and beauty with functionality
- Coupe design offers larger serving area
- Safe for temperatures up to 212°F
- One-year limited warranty
- NSF Listed; dishwasher safe

Epicure® Shapes

Tasting Plates

- One of a kind shapes add variety when serving appetizers, desserts or specialty foods



| Prod No | Description | Color | Pack |
|---------------------------|-----------------------------------|---------|-------|
| Epicure Dinnerware | | | |
| 43800 Δ | 12" Buffet/Pizza Plate | 02 | 12 ea |
| 43801 Δ | 10" Dinner Plate | 02 | 48 ea |
| 43803 Δ | 8" Dinner Plate | 02 | 48 ea |
| 5933 Δ | 32 oz, 8.25" Vegetable Bowl | 02 | 24 ea |
| 43813 Δ | 36 oz, 8" Chef Salad/Serving Bowl | 02 | 12 ea |
| 43814 Δ | 20 oz, 6.5" Soup/Salad Bowl | 02 | 12 ea |
| Epicure Shapes | | | |
| 43806 Δ | 11" TriArc Plate | 02, 03* | 4 ea |
| 43822 Δ | 6.25" Square Plate | 02 | 48 ea |

NSF Listed products are designated with a Δ and may be prefixed with an N

* Color available by special order only

DINNERWARE ACCENT PIECES

Tulip Dishes

- Ideal for serving ice cream, puddings, salads and more
- Stack with similar glass or plastic dessert dishes
- Made of break-resistant SAN
- 4532, 4534 are also available in extra-durable polycarbonate
- Tulip Dishes are the perfect compliment to the Coldmaster® Ice Cream Server shown below
- NSF Listed; dishwasher safe



Ice Cream Server & Lid

- Coldmaster technology and benefits (see pages 108 – 117)
- Accommodates standard 3-gallon ice cream tubs
- Free, clear polycarbonate lid included with each Coldmaster Ice Cream Server
- Replacement Lids (CM1013) also available

Ice Cream Shroud

- Attractive stainless steel cover offers an upscale appearance

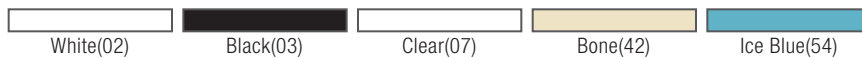

| Prod No | Description | Color | Pack |
|--|-------------------------------------|----------------|-------|
| Tulip Dishes | | | |
| 4530 Δ | 5 oz, 3.75" SAN Tulip Dessert Dish | 03, 07, 42, 54 | 24 ea |
| 4532 $\Delta \blacklozenge$ | 5 oz, 3.75" PC Tulip Dessert Dish | 07 | 24 ea |
| 4531 Δ | 5 oz, 4.63" SAN Tulip Berry Dish | 03, 07, 42 | 24 ea |
| 4535 Δ | 8 oz, 4.63" SAN Tulip Berry Dish | 07 | 48 ea |
| 4533 Δ | 13 oz, 5.5" SAN Tulip Bowl | 07 | 24 ea |
| 4534 $\Delta \blacklozenge$ | 13 oz, 5.5" PC Tulip Bowl | 07 | 24 ea |
| Coldmaster Ice Cream Server, Lid & Shroud | | | |
| CM1012 $\Delta \blacklozenge$ | 3 gal Coldmaster Ice Cream Server | 02, 03 | 1 ea |
| CM1013 \blacklozenge | Lid for Coldmaster Ice Cream Server | 07 | 1 ea |
| 38655 | Coldmaster Ice Cream Shroud | — | 1 ea |

NSF Listed products are designated with a Δ and may be prefixed with an N

\blacklozenge California Residents: Bisphenol A **WARNING:** See appendix A on page 1

PLATES & BOWLS

Tough polycarbonate **Petal Mist**

provides heavy duty serving pieces with a design that looks great longer! Textured exterior hides scratches. Smooth interior makes it easy to clean.

Petal Mist®

- Perfect for buffets, food bars, delis, poolside and catering
- Made of tough, break-resistant polycarbonate
- Textured exterior hides scratches; smooth interior is easy to clean
- Safe for use in freezers and in temperatures from 40° to 212°F
- See page 95 for additional Petal Mist trays and bowls
- NSF Listed; dishwasher safe



Leaf Plates

- Intricate leaf pattern enhances food appearance
- Molded of durable SAN for long life
- Dishwasher safe



| Prod No | Description | Color | Pack |
|--------------------------------------|---|--------|-------|
| Petal Mist Plates & Bowls | | | |
| 6904 ▲◆ | 18 oz, 6" Petal Mist Bowl | 03, 07 | 36 ea |
| 6954 ▲◆ | 7.5" Petal Mist Plate | 07 | 36 ea |
| 6907 ▲◆ | 23.9 oz, 8" Petal Mist Soup/Salad Plate | 07 | 36 ea |
| 6956 ▲◆ | 9" Petal Mist Plate | 07 | 36 ea |
| Leaf Plates | | | |
| 0345 | 6" Leaf Plate | 07 | 36 ea |
| 0347 | 9" Leaf Plate | 07 | 12 ea |

NSF Listed products are designated with a ▲ and may be prefixed with an N
◆ California Residents: Bisphenol A **WARNING:** See appendix A on page 1



PLATES & BOWLS

Melamine Salad Bowls

- Made of dependable, impact-resistant melamine
- Safe for temperatures up to 212°F
- NSF Listed; dishwasher safe



Charger Plates

- Beautiful mirror-finish charger plates are an elegant addition to any place setting
- Easy care tarnish-resistant finish
- Hand wash only



| Prod No | Description | Color | Pack |
|-----------------------------|---------------------------------|-------|-------|
| Melamine Salad Bowls | | | |
| 500B Δ | 8 oz, 5.5" Melamine Salad Bowl | 03 | 72 ea |
| 575B Δ | 13 oz, 6" Melamine Salad Bowl | 03 | 72 ea |
| 650B Δ | 20 oz, 6.5" Melamine Salad Bowl | 03 | 72 ea |
| 800B Δ | 24 oz, 7.5" Melamine Salad Bowl | 03 | 48 ea |
| 500M Δ | 10 oz, 5.5" Melamine Salad Bowl | 20 | 72 ea |
| 575M Δ | 10 oz, 6" Melamine Salad Bowl | 20 | 72 ea |
| 650M Δ | 20 oz, 6.5" Melamine Salad Bowl | 20 | 72 ea |
| 800M Δ | 27 oz, 7.5" Melamine Salad Bowl | 20 | 48 ea |
| Charger Plates | | | |
| 608924 | 12.25" Charger Plate, Chrome | — | 12 ea |

NSF Listed products are designated with a Δ and may be prefixed with an N

Microwave-Ware

- Polycarbonate serving accessories designed specifically for microwave cooking
- Stays cool to the touch when coming out of the microwave
- Extremely impact resistant
- Small 8 oz Casserole is perfect for salads and sides—easily doubles as an olive, nut or butter dish on buffets
- Temperature use range: -40° to 212°F
- Dishwasher safe



7420



7400

Soup Service

- Hefty, thick-walled designs keep food and beverages hot
- Stackable 12 oz Jumbo Soup/Latté Mug (4512) has polycarbonate inner liner and SAN exterior
- 8 and 12 oz handled bowls stack for storage; easy-grab handles are perfect for buffet lines



Our Soup Service Pieces are designed to pair perfectly with our Durus and Sierras Dinnerware.

See page 14-17 for more information



7006



4512



7008

| | | | |
|-----------|------------------|-----------------|-------------------|
| White(02) | Meadow Green(09) | Ocean Blue(14) | |
| Stone(19) | Honey Yellow(22) | Lenox Brown(28) | Sunset Orange(52) |

| Prod No | Description | Color | Pack |
|-----------------------|---|------------------------|-------|
| Microwave-Ware | | | |
| 7400 ▲◆ | 12 oz, 5.25" x 8.75" Oval Casserole | 02 | 24 ea |
| 7405 ▲◆ | 8 oz, 4.25" x 7.5" Oval Casserole Dish | 02 | 24 ea |
| 7420 ◆ | 12 oz, 5.25" Handled Soup Bowl | 02 | 24 ea |
| Soup Service | | | |
| 7006 | 8 oz, 4.63" Handled Soup Bowl | 09, 14, 19, 22, 28, 52 | 24 ea |
| 7008 | 12 oz, 5.25" Handled Soup Bowl | 19, 28 | 24 ea |
| 4512 ◆ | 12 oz, 5.5" Jumbo Soup/Latté Mug with White Liner | 19, 28 | 24 ea |

NSF Listed products are designated with a ▲ and may be prefixed with an N
 ◆ California Residents: Bisphenol A **WARNING:** See appendix A on page 1

PLATE COVERS

Polyglass Plate Covers

- Available to fit a wide variety of plate sizes and footprints
- Polyglass (PG) plate covers are designed for use in microwaves and heated carts
- Heat resistant to 270°F yet stays cool to the touch; excellent insulation properties
- Impact-resistant material offers a superior alternative to standard fiberglass covers
- NSF Listed; dishwasher safe



Polycarbonate Plate Covers

- Clear covers for easy viewing of food
- Highly heat- and break-resistant
- 1960 and 1992 also fit European “pin-fired” footless style plates for secure stacking
- Can be used in heated carts or under heat lamps up to 212°F
- Dishwasher safe



| Prod No | Description | Color | Pack |
|-----------------------------------|--|----------|-------|
| Polyglass Plate Covers | | | |
| 91020 Δ | 8.75" – 9.13" Polyglass Cover | 202 | 12 ea |
| 91040 Δ^* | 9.5" – 10" Polyglass Cover | 202 | 12 ea |
| 91055 Δ | 10.13" – 10.5" Polyglass Cover | 202 | 12 ea |
| 91070 Δ | 10.25" – 10.63" Polyglass Cover | 202 | 12 ea |
| 91065 Δ | 10.13" – 10.38" Polyglass Cover | 202 | 12 ea |
| 91080 Δ | 10.5" – 10.75" Polyglass Cover | 202, 203 | 12 ea |
| 91075 Δ | 10.63" – 10.69" Polyglass Cover | 202 | 12 ea |
| 91085 Δ | 11" – 11.25" Polyglass Cover | 202 | 12 ea |
| 91090 Δ | 11.75" – 12" Polyglass Cover | 202 | 12 ea |
| 91095 Δ | 12" – 12.25" Polyglass Cover | 202 | 12 ea |
| Polycarbonate Plate Covers | | | |
| 1900 \blacklozenge | 8.69" to 9.13" PC Cover | 07 | 12 ea |
| 1960 \blacklozenge | 9" Combination "Pin-Fired" Plate & Bowl PC Cover | 07 | 12 ea |
| 1965 \blacklozenge | 9.44" to 9.75" PC Cover | 07 | 12 ea |
| 1987 \blacklozenge | 9.81" to 10" PC Cover | 07 | 12 ea |
| 1989 \blacklozenge | 10.81" to 10.25" PC Cover | 07 | 12 ea |
| 1991 $\Delta \blacklozenge$ | 10.5" to 10.63" PC Cover | 07 | 12 ea |
| 1992 $\Delta \blacklozenge$ | 10.5" to 10.63" "Pin-Fired" PC Cover | 07 | 12 ea |
| 1993 \blacklozenge | 10.75" to 11" PC Cover | 07 | 12 ea |
| 1994 \blacklozenge | 12" PC Cover | 07 | 12 ea |

NSF Listed products are designated with a Δ and may be prefixed with an N

* Item available by special order only

\blacklozenge California Residents: Bisphenol A **WARNING:** See appendix A on page 1

Custom Acrylic Plate Covers

- Excellent for keeping food warm
- Made to order for undersized or oversized plates and platters
- Use for table service or patient serving
- Dishwasher safe up to 180°F

Custom Plate Covers

Ordering information

- Contact your customer service representative for minimum order quantities
- Two samples of each item are required for quote
- Please allow four to six (4-6) weeks for delivery of samples
- Custom plate cover orders require customer approval of samples prior to production
- If cover has not been previously molded, additional tooling charges apply
- A size variance of 0.13" is possible in the manufacturing of this product
- Larger and smaller sizes of custom covers by special quotation only
- Custom covers are not returnable

CUSTOMIZE



Note: Do not use Acrylic Plate Covers in heated carts, under heat lamps, or near exposed heat sources; safe for temperatures under 130°F

| | |
|-------------|-----------|
| | |
| Translucent | Clear(07) |

| Prod No | Description | Color | Pack |
|--|-----------------------------------|-------|-------|
| Custom Acrylic Clear Round Plate Covers | | | |
| Group A | 7" And Under Acrylic Round Cover | 07 | 24 ea |
| Group B | 7.06" – 8" Acrylic Round Cover | 07 | 24 ea |
| Group C | 8.06" – 10" Acrylic Round Cover | 07 | 24 ea |
| Group D | 10.06" – 14" Acrylic Round Cover | 07 | 24 ea |
| Group E | 14.06" – 16" Acrylic Round Cover | 07 | 24 ea |
| Custom Acrylic Translucent Round Plate Covers | | | |
| Group AT | 7" And Under Acrylic Round Cover | 02 | 24 ea |
| Group BT | 7.06" – 8" Acrylic Round Cover | 02 | 24 ea |
| Group CT | 8.06" – 10" Acrylic Round Cover | 02 | 24 ea |
| Group DT | 10.06" – 14" Acrylic Round Cover | 02 | 24 ea |
| Group ET | 14.06" – 16" Acrylic Round Cover | 02 | 24 ea |
| Custom Acrylic Clear Oval Plate Covers | | | |
| Group P1 | 11" And Under Acrylic Oval Cover | 07 | 24 ea |
| Group P2 | 11.06" – 12.5" Acrylic Oval Cover | 07 | 24 ea |
| Group P3 | 12.56" – 14" Acrylic Oval Cover | 07 | 24 ea |
| Group P4 | 14.06" – 16" Acrylic Oval Cover | 07 | 24 ea |
| Custom Acrylic Translucent Oval Plate Covers | | | |
| Group P1T | 11" And Under Acrylic Oval Cover | 02 | 24 ea |
| Group P2T | 11.06" – 12.5" Acrylic Oval Cover | 02 | 24 ea |
| Group P3T | 12.56" – 14" Acrylic Oval Cover | 02 | 24 ea |
| Group P4T | 14.06" – 16" Acrylic Oval Cover | 02 | 24 ea |

NSF Listed products are designated with a **Δ** and may be prefixed with an N



CARLISLE
FOODSERVICE PRODUCTS



CLASSIC
INVITING
ENDURING
BEAUTIFUL
EYE-CATCHING
DRINKWARE

Carlisle offers a complete line of barware, stemware and serveware. Let us help you dress your bar and restaurant with our complete line of break-resistant beverage service products.





DRINKWARE

Update your barware and stemware presentation with the **sophisticated styling** and **unbeatable durability** of Alibi. An excellent choice for outdoor and poolside beverage service.

Alibi™ Barware

- Resistant to staining, breaking and chipping
- Light-weight and durable, making it essential for special occasions and outdoor events
- Thick base on barware feels like traditional glassware
- Wide assortment of styles to choose from
- Personalize it by adding your own brand, logo, label and design; see page 334
- Promotes safety by eliminating risk of broken glass
- Barware is made of BPA free SAN
- Dishwasher safe*



Clear(07)

| Prod No | Description | Glass Rack | Color | Pack |
|----------------------|----------------------------------|----------------|-------|-------|
| Alibi Barware | | | | |
| 5601 | 1.5 oz Alibi Shot | RG49 | 07 | 24 ea |
| 5602 | 2 oz Alibi Shooter | RG49 | 07 | 24 ea |
| 5603 | 3 oz Alibi Shooter/Mini Dessert | RG49 | 07 | 24 ea |
| 5609 | 9 oz Alibi Rocks/Juice | RG25-1, RW20 | 07 | 24 ea |
| 5610 | 10 oz Alibi Hi-Ball | RG49-2 | 07 | 24 ea |
| 5612 | 12 oz Alibi Double Old Fashioned | RG16-1, RW20 | 07 | 24 ea |
| 5614 | 14 oz Alibi Beverage | RG25-2, RW30-1 | 07 | 24 ea |
| 5616 | 16 oz Alibi Pint/Mixing | RG16-2, RW20-1 | 07 | 24 ea |

*Note: Hand washing in bar sinks or 3-compartment sinks will extend life of drinkware



Alibi™ Stemware

- Polycarbonate material is resistant to staining, breaking and chipping
- Great for special occasions and outdoor events
- Thick base & thin stem mimics traditional glassware
- Dishwasher safe



Clear(07)

| Prod No | Description | Glass Rack | Color | Pack |
|---------------------------------------|----------------------------|-------------------------|-------|-------|
| Alibi Drinkware & Stemware | | | | |
| 5644 ♦ | 6 oz Alibi Champagne Flute | RG49-4 | 07 | 24 ea |
| 5640 ♦ | 8 oz Alibi Champagne Flute | RG25-5, RW20-4C, RW30-4 | 07 | 24 ea |
| 5645 ♦ | 8 oz Alibi White Wine | RG25-3, RG36-3, RW30-2 | 07 | 24 ea |
| 5643 ♦ | 11 oz Alibi White Wine | RG16-4, RW20-3 | 07 | 24 ea |
| 5646 ♦ | 9 oz Alibi Martini | RG9-3 | 07 | 24 ea |
| 5642 ♦ | 20 oz Alibi Red Wine | RG16-4, RW20-3 | 07 | 24 ea |
| 5641 ♦ | 22 oz Alibi Balloon | RG16-4 | 07 | 24 ea |
| 5648 ♦ | 15 oz Water | RG25-3, RW20-2 | 07 | 24 ea |
| 5649 ♦ | 16 oz Pilsner | RG25-5, RW20-4C, RW30-4 | 07 | 24 ea |
| 5650 ♦ | 16 oz Hurricane | RG36-4, RW30-3 | 07 | 24 ea |
| 5651 ♦ | 11 oz Margarita | RG9-3 | 07 | 24 ea |
| 5652 ♦ | 16 oz Margarita, Grande | RG9-3 | 07 | 24 ea |

DRINKWARE

The look of recycled glass, the durability of Tritan plastic.

Mingle

- The look and feel of recycled glass drinkware
- Tritan offers durability that withstands heavy use in your venue
- Durable Tritan is break and craze-resistant
- Stain resistant
- BPA Free
- NSF Listed; dishwasher safe
- Two-year limited warranty



Coordinating pitchers listed on page 51



RECOMMENDED GLASS RACK IS LISTED IN THE PRODUCT CHART

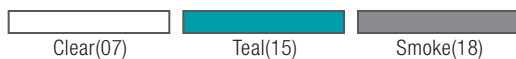

| Prod No | Description | Glass Rack | Color | Pack |
|-------------------------|----------------------------|----------------|------------|-------|
| Mingle Drinkware | | | | |
| MIN5441 Δ | 6 oz Juice Cup | RG49-1 | 07, 15, 18 | 12 ea |
| MIN5440 Δ | 14 oz Double Old Fashioned | RG16-1, RW20 | 07, 15, 18 | 12 ea |
| MIN5442 Δ | 19 oz Highball | RG16-2, RW20-1 | 07, 15, 18 | 12 ea |
| MIN5449 Δ | 22 oz High Ball | RG16-3, RW20-2 | 07 | 12 ea |

NSF Listed products are designated with a Δ and may be prefixed with an N

SAN TUMBLERS

Carlisle leads the industry in **durable SAN Tumblers**. The variety of sizes, finishes and decorating opportunities are sure to **satisfy all of your tumbler needs**.

Stackable

- Durable SAN reduces breakage
- Tapered sides make tumblers easy to stack
- Interior lugs prevent jamming when stored
- Textured exterior hides wear and tear
- Custom decorating available; see page 334
- BPA free
- NSF Listed; dishwasher safe

Note: Please specify case pack when ordering



| Prod No | Description | Disposable Lid | Glass Rack | Color | Pack |
|--------------------------|--|----------------|------------------------|--------------------|-------|
| SAN – Large Packs | | | | | |
| 5501 Δ | 5 oz SAN Stackable Tumbler | DX1193ST8714* | RG49-1 | 07, 10, 13, 47, 54 | 72 ea |
| 5526 Δ | 8 oz SAN Stackable Tumbler | DX1191ST8714* | RG36-1 | 07, 10, 13, 47, 54 | 72 ea |
| 5529 Δ | 9 oz Old Fashioned SAN Stackable Tumbler | DXTT58* | RG25-1, RW20 | 07, 13 | 72 ea |
| 5506 Δ | 9.5 oz SAN Stackable Tumbler | 5506L | RG25-1, RG36-1, RW30 | 07, 10, 13, 47, 54 | 72 ea |
| 5212 Δ | 12 oz SAN Stackable Tumbler | 5212L | RG25-2, RW20-1, RW30-1 | 07, 10, 13, 47, 54 | 72 ea |
| 5216 Δ | 16 oz SAN Stackable Tumbler | DXTT58* | RG25-2, RW20-1 | 07, 10, 13, 47, 54 | 72 ea |
| 5220 Δ | 20 oz SAN Stackable Tumbler | DX30008714* | RG16-3, RW20-2 | 07, 10, 13, 47, 54 | 72 ea |
| 5224 Δ | 24 oz SAN Stackable Tumbler | DXTT45* | RG16-3, RW20-2 | 07, 10, 13 | 72 ea |
| 5232 Δ | 32 oz Tall SAN Stackable Tumbler | — | RG16-4 | 07, 10 | 24 ea |
| 5532 Δ | 32 oz SAN Stackable Tumbler | — | RG16-3 | 07, 10, 13 | 48 ea |
| 43937 Δ | 5.5 oz Low Profile SAN Stackable Tumbler | — | RG16, RW20 | 07 | 72 ea |
| SAN – Small Packs | | | | | |
| 5501-2 Δ | 5 oz SAN Stackable Tumbler | DX1193ST8714* | RG49-1 | 07 | 24 ea |
| 5526-2 Δ | 8 oz SAN Stackable Tumbler | — | RG36-1 | 07 | 24 ea |
| 5529-2 Δ | 9 oz Old Fashioned SAN Stackable Tumbler | DXTT58* | RG25-1, RW20 | 07 | 24 ea |
| 5532-2 Δ | 32 oz SAN Stackable Tumbler | — | RG16-3 | 07** | 24 ea |
| 5506-2 Δ | 9.5 oz SAN Stackable Tumbler | 5506L | RG25-1, RG36-1, RW30 | 07 | 24 ea |
| 5212-2 Δ | 12 oz SAN Stackable Tumbler | 5212L | RG25-2, RW20-1, RW30-1 | 07 | 24 ea |
| 5216-2 Δ | 16 oz SAN Stackable Tumbler | DXTT58* | RG25-2, RW20-1 | 07 | 24 ea |
| 5220-2 Δ | 20 oz SAN Stackable Tumbler | DX30008714* | RG16-3, RW20-2 | 07 | 24 ea |

NSF Listed products are designated with a Δ and may be prefixed with an N

Note: *The DX Series Disposable Lids listed above are available through our Dinet Catalog

**Color available by special order only

SAN TUMBLERS

Genuine Coca-Cola® & Pepsi® Stackable Tumblers

- Same features as our regular SAN Stackable Tumblers
- Printed with the famous Coca-Cola® or Pepsi® trademark
- BPA free

Items are Trademarked by the Coca-Cola® Company. Coca-Cola® Stackable Tumblers are available for distribution only to authorized Coca-Cola® fountain customers for commercial foodservice use. Coca-Cola® Stackable Tumblers cannot be used for retail sale to the public.

Items are Trademarked by PepsiCo®. PepsiCo® Stackable Tumblers are available for distribution only to authorized PepsiCo® fountain customers for commercial foodservice use. PepsiCo® Stackable Tumblers cannot be used for retail sale to the public.



| Prod No | Description | Disposable Lid | Glass Rack | Pack |
|-------------------------------------|--------------------------------|----------------|----------------|--------|
| Coca-Cola Stackable Tumblers | | | | |
| 52163550E | 16 oz Coca-Cola Tumbler, Clear | DXTT58* | RG25-2, RW20-1 | 72 ea |
| 52203550A | 20 oz Coca-Cola Tumbler, Clear | DX30008714* | RG16-3, RW20-2 | 72 ea |
| 52243550G | 24 oz Coca-Cola Tumbler, Clear | DXTT45* | RG16-3, RW20-2 | 72 ea |
| 5232-63550J | 32 oz Coca-Cola Tumbler, Clear | — | RG16-4 | 72 ea |
| 52163550D | 16 oz Coca-Cola Tumbler, Ruby | DXTT58* | RG25-2, RW20-1 | 72 ea |
| 52203550 | 20 oz Coca-Cola Tumbler, Ruby | DX30008714* | RG16-3, RW20-2 | 72 ea |
| 52243550H | 24 oz Coca-Cola Tumbler, Ruby | DXTT45* | RG16-3, RW20-2 | 72 ea |
| 5232-63550I | 32 oz Coca-Cola Tumbler, Ruby | — | RG16-3 | 72 ea |
| Pepsi Stackable Tumblers | | | | |
| 5216841C2 | 16 oz Pepsi Clear Script | DXTT58* | RG25-2, RW20-1 | 72 ea. |
| 52163841A | 16 oz Pepsi Ice Blue Script | DXTT58* | RG25-2, RW20-1 | 72 ea. |
| 52163841F | 16 oz Pepsi Royal Blue Script | DXTT58* | RG25-2, RW20-1 | 72 ea. |
| 5216C203 | 16 oz Pepsi Clear Globe | DXTT58* | RG25-2, RW20-1 | 72 ea. |
| 5216RB203 | 16 oz Pepsi Royal Blue Globe | DXTT58* | RG25-2, RW20-1 | 72 ea. |
| 5216IB203 | 16 oz Pepsi Ice Blue Globe | DXTT58* | RG25-2, RW20-1 | 72 ea. |
| 5220841C2 | 20 oz Pepsi Clear Script | DX30008714* | RG16-3, RW20-2 | 72 ea. |
| 52203841B | 20 oz Pepsi Ice Blue Script | DX30008714* | RG16-3, RW20-2 | 72 ea. |
| 52203841G | 20 oz Pepsi Royal Blue Script | DX30008714* | RG16-3, RW20-2 | 72 ea. |
| 5220C203 | 20 oz Pepsi Clear Globe | DX30008714* | RG16-3, RW20-2 | 72 ea. |
| 5220RB203 | 20 oz Pepsi Royal Blue Globe | DX30008714* | RG16-3, RW20-2 | 72 ea. |
| 5220IB203 | 20 oz Pepsi Ice Blue Globe | DX30008714* | RG16-3, RW20-2 | 72 ea. |
| 5224841C2 | 24 oz Pepsi Clear Script | DXTT45* | RG16-3, RW20-2 | 72 ea. |
| 52243841C | 24 oz Pepsi Ice Blue Script | DXTT45* | RG16-3, RW20-2 | 72 ea. |
| 52243841H | 24 oz Pepsi Royal Blue Script | DXTT45* | RG16-3, RW20-2 | 72 ea. |
| 5224C203 | 24 oz Pepsi Clear Globe | DXTT45* | RG16-3, RW20-2 | 72 ea. |
| 5224RB203 | 24 oz Pepsi Royal Blue Globe | DXTT45* | RG16-3, RW20-2 | 72 ea. |
| 5224IB203 | 24 oz Pepsi Ice Blue Globe | DXTT45* | RG16-3, RW20-2 | 72 ea. |
| 5232841C2 | 32 oz Pepsi Clear Script | — | RG16-3 | 24 ea. |
| 52323841I | 32 oz Pepsi Royal Blue Script | — | RG16-3 | 24 ea. |
| 5232C203 | 32 oz Pepsi Clear Globe | — | RG16-3 | 24 ea. |
| 5232RB203 | 32 oz Pepsi Royal Blue Globe | — | RG16-3 | 24 ea. |
| 5232IB243 | 32 oz Pepsi Ice Blue Globe | — | RG16-3 | 24 ea. |

Note: *The DX Series Disposable Lids listed above are available through our Dinx Catalog

Enjoy the **timeless shape** of Louis Tumblers. Perfect for service where breakage is a concern. **Well balanced with the feel of heavy glass.**



RECOMMENDED GLASS RACK IS LISTED IN THE PRODUCT CHART

Louis™

- Faceted shape offers easy grip
- Appearance of glass
- Made of break-resistant SAN
- Stackable space saving feature
- Custom decorating available; see page 334
- BPA free
- NSF Listed; dishwasher safe



An attractive, classic tumbler collection. **Perfect for healthcare and hospitals.**

Lorraine™

- Attractive panel and facet design
- Made of break-resistant SAN
- 43649—9 oz Old Fashioned is designed for healthcare tray service, bar or room service
- 43647—6 oz size meets healthcare portion standards
- Stacking lugs prevent jamming
- BPA free
- Dishwasher safe

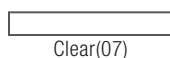

| Prod No | Description | Disposable Lid | Glass Rack | Color | Pack |
|------------------------------|-------------------------------------|----------------|------------------------|-------|-------|
| Louis SAN Tumblers | | | | | |
| 5806 Δ | 6 oz Louis Tumbler | DX11968714* | RG25-1, RG36-1, RW30 | 07 | 24 ea |
| 5808 Δ | 8 oz Louis Rocks | DX22259000* | RG25-1, RW20 | 07 | 24 ea |
| 5810 Δ | 10 oz Louis Tumbler | 5810L | RG25-1, RW30 | 07 | 24 ea |
| 5812 Δ | 12 oz Louis Rocks | 5812L | RG16-1, RW20 | 07 | 24 ea |
| 5814 Δ | 14 oz Louis Tumbler | DXTT501* | RG25-2, RW20-1, RW30-1 | 07 | 24 ea |
| 5816 Δ | 16 oz Louis Tumbler | DXTT58* | RG25-2, RW20-1 | 07 | 24 ea |
| 5818 Δ | 18 oz Louis Tumbler | DXTT58* | RG25-3, RW20-2 | 07 | 24 ea |
| 5820 Δ | 20 oz Louis Tumbler | — | RG16-3, RW20-2 | 07 | 24 ea |
| 5822 Δ | 22 oz Louis Tumbler | 5822L | RG16-3, RW20-2 | 07 | 24 ea |
| 5832 Δ | 32 oz Louis Tumbler | — | RG16-3 | 07 | 24 ea |
| Lorraine SAN Tumblers | | | | | |
| 43647 | 6 oz Lorraine Tumbler | — | RG36-1, RW30 | 07 | 24 ea |
| 43648 | 8 oz Lorraine Tumbler | 1110L | RG25-1, RW30 | 07 | 24 ea |
| 43649 | 9 oz Lorraine Old Fashioned Tumbler | DXTT59* | RG16-1, RW20 | 07 | 24 ea |
| 43651 | 12 oz Lorraine Tumbler | — | RG25-2, RW20-1 | 07 | 24 ea |
| 43653 | 16 oz Lorraine Tumbler | DX30008714* | RG16-2, RW20-1 | 07 | 24 ea |
| 43655 | 22 oz Lorraine Tumbler | — | RG16-3 | 07 | 24 ea |

NSF Listed products are designated with a Δ and may be prefixed with an N

Note: *The DX Series Disposable Lids listed above are available through the Carlisle | Dinex Catalog



SAN TUMBLERS

Bistro's **classic design works everywhere** from trendy restaurants to small town diners. Bistro never goes out of style.

Bistro™

- Attractive traditional fluted exterior
- Interior lugs prevent jamming when stored
- Made of break-resistant SAN
- BPA free
- Dishwasher safe



The perfect stacking tumbler to use in healthcare and other **situations where a better grip is helpful.**

Crystalon® Stack-All®

- Stylish, ribbed texture offers better grip
- Made of break-resistant SAN
- Stacking lugs prevent jamming when stored
- Crystalon RimGlow™ also available, see page 45
- BPA free
- Dishwasher safe

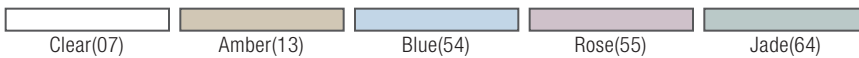

| Prod No | Description | Disposable Lid | Glass Rack | Color | Pack |
|---|--|----------------|------------------------|--------------------|--------|
| Bistro SAN Tumblers | | | | | |
| 1104 | 4 oz Bistro Tumbler | — | RG49-1 | 07 | 144 ea |
| 1105 | 5 oz Bistro Tumbler | DX11928714* | RG49-1 | 07 | 144 ea |
| 1108 | 8 oz Bistro Tumbler | — | RG36-1, RW30 | 07 | 72 ea |
| 1110 | 10 oz Bistro Tumbler | 1110L | RG25-1, RW30 | 07 | 72 ea |
| 1112 | 12 oz Bistro Tumbler | DX11808714* | RG25-2, RW30-1 | 07 | 72 ea |
| 1116 | 16 oz Bistro Tumbler | — | RG25-2, RW20-1 | 07 | 72 ea |
| 0120 | 20 oz Bistro Tumbler | DX21259000* | RG16-3, RG25-3, RW20-2 | 07 | 72 ea |
| 0132 | 32 oz Bistro Tumbler | — | RG16-3 | 07 | 48 ea |
| Crystalon SAN Stack-All Tumblers | | | | | |
| 4008 | 8 oz Crystalon SAN Tumbler | DX1198ST8714* | RG25-1, RW30 | 07, 55 | 48 ea |
| 4029 | 9 oz Old Fashioned Crystalon SAN Tumbler | DX21259000* | RG25, RW20 | 07, 55**, 64 | 48 ea |
| 4010 | 9.5 oz Crystalon SAN Tumbler | — | RG25-1, RW30 | 07, 54 | 48 ea |
| 4012 | 12 oz Crystalon SAN Tumbler | 5212L | RG25-2, RW20-1 | 07, 13, 54, 55, 64 | 48 ea |
| 4016 | 16 oz Crystalon SAN Tumbler | DXTT58* | RG25-2, RW20-1 | 07, 13, 54, 55, 64 | 48 ea |
| 4020 | 20 oz Crystalon SAN Tumbler | — | RG16-2, RW20-1 | 07, 13, 54, 55, 64 | 48 ea |

*The DX Series Disposable Lids listed above are available through the Carlisle | Dinex Catalog

**Color available by special order only

Genuine Coca-Cola® Tumbler

- Classic shape with the appearance of glass
- Dishwasher safe; stackable
- Available in clear with Coca-Cola® logo
- Break-resistant
- BPA free SAN

These items are Trademarked by the Coca-Cola® Company. Coca-Cola® Stackable Tumblers are available for distribution only to authorized Coca-Cola® fountain customers for commercial foodservice use. Coca-Cola® Stackable Tumblers cannot be used for retail sale to the public.



The tried and true diner tumblers continue to delight customers around the world.

Pebble Optic™

- Attractive pebbled exterior hides scratches
- Thick-walled SAN construction offers sturdy feel
- 5 oz, 8 oz, 9.5 oz and 12 oz sizes have stacking feature on bottom
- BPA free
- Dishwasher safe



| Prod No | Description | Disposable Lid | Glass Rack | Color | Pack |
|----------------------------------|-----------------------------------|----------------|------------------------|--------------|-------|
| Genuine Coca-Cola Tumbler | | | | | |
| 439945200 | 24 oz Coca-Cola Tumbler with Logo | | RTP | — | 72 ea |
| Pebble Optic Tumblers | | | | | |
| 5505 | 5 oz Pebble Optic Tumbler | DX24019000* | RG49-1 | 07 | 24 ea |
| 5508 | 8 oz Pebble Optic Tumbler | — | RG36-1 | 07 | 24 ea |
| 5509 | 9.5 oz Pebble Optic Tumbler | — | RG25-1, RW30 | 07, 10**, 18 | 24 ea |
| 5512 | 12 oz Pebble Optic Tumbler | DX1198ST8714* | RG36-2, RW30-1 | 07, 10, 18 | 24 ea |
| 5517 | 16 oz Pebble Optic Tumbler | — | RG25-2, RW20-1, RW30-1 | 07, 10, 18 | 24 ea |
| 5519 | 20 oz Pebble Optic Tumbler | DX11948714 | RG25-3, RW20-2, RW30-2 | 07 | 24 ea |

Note: *The DX Series Disposable Lids listed above are available through our Dinx Catalog

**Color available by special order only



POLYCARBONATE DRINKWARE

A classic barware line. Trusted by pool management to **delight customers without the worry of breakage.**

Liberty™

- Serve poolside drinks without the breakage worries of glass
- Liberty polycarbonate eliminates the need to sacrifice your presentation with disposables
- Custom decorating available; see page 334
- Dishwasher safe



Clear(07)

| Prod No | Description | Glass Rack | Color | Pack |
|--------------------------|------------------------------------|------------------------|-------|-------|
| Liberty Drinkware | | | | |
| 43628 ♦ | 8 oz Liberty Old Fashioned | RG25-1, RW30 | 07 | 48 ea |
| 43625 ♦ | 18 oz Liberty Double Old Fashioned | RG16-2, RW20-1 | 07 | 24 ea |
| 43626 ♦ | 22 oz Liberty Hi-Ball | RG16-3, RW20-2 | 07 | 24 ea |
| 43623 ♦ | 15 oz Liberty Pilsner | RG25-4, RW20-3 | 07 | 24 ea |
| 43624 ♦ | 9.5 oz Liberty Margarita | RG9-3 | 07 | 24 ea |
| 43627 ♦ | 8 oz Liberty Martini | RG16-3, RG9-3 | 07 | 24 ea |
| 43629 ♦ | 9 oz Liberty Cocktail | RG25-3, RW20-2 | 07 | 24 ea |
| 43620 ♦ | 5 oz Liberty Champagne Flute | RG25-4, RW20-3 | 07 | 24 ea |
| 43631 ♦ | 15 oz Liberty Hurricane | RG25-4, RW20-3 | 07 | 24 ea |
| 43630 ♦ | 13 oz Liberty Cocktail | RG25-3, RW20-2 | 07 | 24 ea |
| 43621 ♦ | 10.5 oz Liberty White Wine | RG16-3, RG25-3, RW20-2 | 07 | 24 ea |
| 43622 ♦ | 13.5 oz Liberty Goblet | RG16-3, RW20-2 | 07 | 24 ea |

♦ California Residents: Bisphenol A **WARNING:** See appendix A on page 1

POLYCARBONATE TUMBLERS

A **fun color grouping** that is a perfect look for poolside or barbecues where breakage is a concern.

Crystalon® RimGlow™

- Tumblers change hue and intensity with variations in lighting, perspective and beverage color
- Mix and match colors in brilliant, long-lasting polycarbonate
- Coordinates with Caribbean color dinnerware shown in the Dinnerware section of this catalog
- Crystalon Stack-All® also available, see page 42
- Dishwasher safe



4035

Stackable

- Ideal for prisons, schools and high-volume chains
- Extremely break-resistant polycarbonate extends tumbler life
- Dishwasher safe



RECOMMENDED GLASS RACK IS LISTED IN THE PRODUCT CHART



5120

5116-2

5108-2

5105-2



| Prod No | Description | Disposable Lid | Glass Rack | Color | Pack |
|---|------------------------------|----------------|--------------------------------|------------------|-------|
| Crystalon Polycarbonate RimGlow Tumblers | | | | | |
| 4033 ♦ | 12 oz Crystalon PC Tumbler | 5212L | RG25-2, RW20-1, RW30-1 | 09, 14, 22** | 48 ea |
| 4034 ♦ | 16 oz Crystalon PC Tumbler | DXTT58* | RG25-2, RW20-1 | 07, 09, 14, 22** | 48 ea |
| 4035 ♦ | 20 oz Crystalon PC Tumbler | — | RG16-2, RG16-3, RW20-1, RW20-2 | 09, 14, 22 | 48 ea |
| Polycarbonate Stackable Tumblers | | | | | |
| 5105-2 ♦ | 5 oz PC Stackable Tumbler | DX1193ST8714* | RG16, RW20 | 07 | 24 ea |
| 5108-2 ♦ | 8 oz PC Stackable Tumbler | — | RG36-1 | 07 | 24 ea |
| 5109-2 ♦ | 9.5 oz PC Stackable Tumbler | 5109L | RG25-1, RG36-1, RW30 | 07 | 24 ea |
| 5116-2 ♦ | 16.5 oz PC Stackable Tumbler | DX22259000* | RG25-2, RW20-1 | 07, 10 | 24 ea |
| 5120 ♦ | 20 oz PC Stackable Tumbler | DX30008714* | RG25-3, RW20-2 | 07 | 24 ea |

*The DX Series Disposable Lids listed above are available through the Carlisle | DineX Catalog

**Color available by special order only

♦ California Residents: Bisphenol A **WARNING:** See appendix A on page 1

POLYCARBONATE TUMBLERS

Another classic design from Carlisle. **Six sizes available for all of your bar needs.**

Lafayette®

- Distinctive fluted pattern has the look and style of glass
- Perfect for bar service, room service, or catered events
- Stacking lugs prevent jamming
- Slotted base allows complete draining
- Dishwasher safe



Swirl

- Unique swirl design creates a perfect, glass-like tabletop beverage presentation
- Dishwasher safe



RECOMMENDED GLASS RACK IS LISTED IN THE PRODUCT CHART

Clear(07)

| Prod No | Description | Disposable Lid | Glass Rack | Color | Pack |
|---|--|----------------|------------------------|-------|-------|
| Lafayette Polycarbonate Tumblers | | | | | |
| 43633 ♦ | 8 oz Lafayette PC Tumbler | DX20029000* | RG36-1, RW30 | 07 | 36 ea |
| 43635 ♦ | 10 oz Lafayette PC Tumbler | — | RG25-2, RW30-1 | 07 | 36 ea |
| 43636 ♦ | 12 oz Lafayette PC Tumbler | — | RG25-2, RW20-1, RW30-1 | 07 | 36 ea |
| 43637 ♦** | 12 oz Lafayette PC Old Fashioned Tumbler | DX21259000* | RG16-1, RG25-1, RW20 | 07 | 36 ea |
| 43638 ♦ | 16 oz Lafayette PC Tumbler | DX21259000* | RG25-2, RW20-1 | 07 | 36 ea |
| 43640 ♦ | 22 oz Lafayette PC Tumbler | — | RG16-3, RW20-2 | 07 | 36 ea |
| Swirl Polycarbonate Tumblers | | | | | |
| 43662 ♦ | 5 oz Swirl PC Tumbler | — | RG49-1 | 07 | 36 ea |
| 43663 ♦ | 8 oz Swirl PC Tumbler | DX20029000* | RG36-1, RW30 | 07 | 36 ea |
| 43664 ♦ | 9 oz Swirl PC Tumbler | — | RG25-1, RW20 | 07 | 36 ea |
| 43665 ♦ | 10 oz Swirl PC Tumbler | — | RG25-2, RW30-1 | 07 | 36 ea |
| 43666 ♦ | 12 oz Swirl PC Tumbler | — | RG25-2, RW20-1, RW30-1 | 07 | 36 ea |
| 43668 ♦ | 16 oz Swirl PC Tumbler | — | RG16-2, RG25-2, RW20-1 | 07 | 36 ea |
| 43674 ♦ | 22 oz Swirl PC Tumbler | — | RG16-3, RW20-2 | 07 | 36 ea |

Note: *The DX Series Disposable Lids listed above are available through the Carlisle | DineX Catalog

♦ California Residents: Bisphenol A **WARNING:** See appendix A on page 4

** Item available by special order only

CARAFES & MUGS

Stylish design makes **Cascata** Carafes the most **attractive** carafe you can choose for tabletops and buffets, while offering **convenience** and superior **functionality**.

Cascata Carafe

- Ergonomic shape is easy to hold and angled rim provides a drip-free pour
- Larger sizes can be used for water, juice or wine
- Smaller sizes are good for salad dressings, syrups, single-portion drinks and snack mix
- A green alternative to single-serve drinks
- Snap-on lids available in solid or hinged styles and fit .5, 1 and 1.5 Liter Carafes
- All sizes have capacity marks for portion control
- Durable polycarbonate looks like glass
- NSF Listed; dishwasher safe



Snap-on lids available in solid or hinged styles

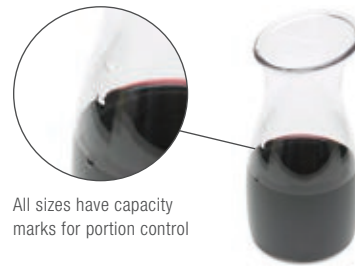

All sizes have capacity marks for portion control



70900

70902 with 70905 Lid

70903

70901 with 70904 Lid



7000

2 Cup Carafe

- Durable SAN 11 oz capacity carafe is perfect for room service, hospitals, nursing homes, restaurants and cafeterias
- Ribbed neck and textured finish provide a better grip and greater safety than glass bottles
- BPA free
- Dishwasher safe



| Prod No | Description | Capacity Marks | Glass Rack | Color | Pack |
|-----------------------------------|--|-----------------------|----------------|-------|-------|
| Cascata Carafes & Lids | | | | | |
| 70900 Δ ♦ | 0.25 Liter Carafe | 6 oz, 8 oz, 0.25L | RG25-2, RW30-1 | 07 | 12 ea |
| 70901 Δ ♦ | 0.50 Liter Carafe | 0.5L | RG16-3, RW20-2 | 07 | 12 ea |
| 70902 Δ ♦ | 1 Liter Carafe | 1.0L | RG16-5 | 07 | 12 ea |
| 70903 Δ ♦ | 1.5 Liter Carafe | 1.5L | — | 07 | 12 ea |
| 70904 Δ | Flat Carafe Lid (fits 70901, 70902, 70903) | — | — | 02 | 12 ea |
| 70905 Δ | Hinged Carafe Lid (fits 70901, 70902, 70903) | — | — | 02 | 12 ea |
| 2 Cup Carafe | | Disposable Lid | | | |
| 7000 | 11 oz Carafe | DX55-57* | RG16-2 | 07 | 36 ea |

NSF Listed products are designated with a Δ and may be prefixed with an N

Note: *The DX Series Disposable Lids listed above are available through the Carlisle | Dinex Catalog

♦ California Residents: Bisphenol A **WARNING:** See appendix A on page 1

MUGS

Lexington™ Polycarbonate Mug

- Heavy-weight mug offers traditional styling in durable polycarbonate
- Crystal clear mug has the look and feel of glass without the replacement
- Recessed drain for easy drying
- Dishwasher safe



43965

Carlisle Mugs

- Made of break-resistant, BPA free Tritan
- Specially designed, large handle allows for easy holding, keeps fingers away from hot liquids
- Available in 6 colors to coordinate with Carlisle's existing dinnerware lines
- Safe for temperatures up to 190°F (88°C)
- Custom decorating available; see page 334
- NSF Listed; dishwasher safe



43068

43066



Coffee Mugs

- Rugged, chip- and crack-resistant plastic to give you long-wearing service
- Diablo mugs have double-wall construction to maintain hot temperatures longer
- Diablo II has single-wall construction for money-saving service
- All mugs are dishwasher safe



8004

8104

4512

Customized mugs help promote your company or services. Contact Customer Service at 1-800-654-8210 for imprinting information.

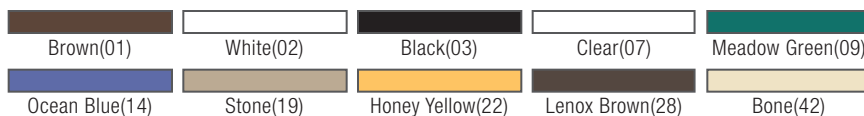

| Prod No | Description | Disposable Lid | Glass Rack | Color | Pack |
|------------------------------------|---|----------------|--------------|------------------------|-------|
| Lexington Polycarbonate Mug | | | | | |
| 43965 ♦ | 16 oz Lexington Mug | — | RG9-3 | 07 | 12 ea |
| Carlisle Mugs | | | | | |
| 43066 | 8 oz Carlisle Mug | 5109L | RG16-1 | 02, 03, 09, 14, 22, 42 | 12 ea |
| 43068 | 12 oz Carlisle Mug | — | RG25-1, RW20 | 02, 03, 09, 14, 22, 42 | 12 ea |
| Coffee Mugs | | | | | |
| 8004 ♦ | 8 oz, 4.13" Diablo Mug with White Liner | — | RG16-1 | 01, 02 | 36 ea |
| 8104 | 8 oz, 4.13" Diablo II Mug | — | RG16-1 | 01 | 36 ea |
| 4512 ♦ | 12 oz, 5.5" Jumbo Soup/Latté Mug | — | RG9, RTP | 19, 28 | 24 ea |

Note: *The DX Series Disposable Lids listed above are available through the Carlisle | DineX Catalog

♦ California Residents: Bisphenol A **WARNING:** See appendix A on page 1

PITCHERS

Carlisle offers the perfect selection of break-resistant pitchers. **They are an industry favorite.**

VersaPour® Pitchers

- Lip design allows for easy pouring with ice from front or either side without splashing
- Sure grip ergonomic handle and thumb grip help control pouring
- Made of break-resistant polycarbonate for ultimate durability
- Thinner wall provides optimum strength and durability; reduces wait staff's wrist stress
- 5544 Window Pitcher provides a smooth surface for printing your logo; accommodates up to 2.88" wide by 2" tall image
- Custom decorating available; see page 334
- 5546 and 5547 are made of BPA free SAN
- NSF Listed; dishwasher safe

VersaPour's specially contoured lip design allows for easy pouring with ice from front or sides without splashing



Polycarbonate Pitchers

- Ice trap retains ice or beer foam
- Made of break-resistant polycarbonate for ultimate durability
- NSF Listed; dishwasher safe



| Prod No | Description | Color | Pack |
|---|--------------------------------|--------|------|
| VersaPour Polycarbonate Pitchers | | | |
| 5540 Δ ♦ | 60 oz VersaPour Pitcher | 07, 13 | 6 ea |
| 5544 Δ ♦ | 60 oz VersaPour Window Pitcher | 07 | 6 ea |
| VersaPour SAN Pitchers | | | |
| 5546 Δ | 60 oz VersaPour Pitcher | 07 | 6 ea |
| 5547 Δ | 60 oz VersaPour Window Pitcher | 07 | 6 ea |
| Polycarbonate Pitchers | | | |
| 5536 Δ ♦ | 32 oz Polycarbonate Pitcher | 07 | 6 ea |
| 5538 Δ ♦ | 48 oz Polycarbonate Pitcher | 07 | 6 ea |

NSF Listed products are designated with a Δ and may be prefixed with an N
 ♦ California Residents: Bisphenol A **WARNING:** See appendix A on page 1

PITCHERS

Crystalite® Polycarbonate Pitchers

- Tapered lip permits controlled pouring of the beverage and ice
- Secure thumb hold on handle aids control of pitcher while pouring
- Slot at skirt base deters water collection
- Made of break-resistant polycarbonate for ultimate durability
- NSF Listed; dishwasher safe



Élan™ Polycarbonate Pitcher

- Thick walls and optic bottom gives these pitchers the look of glass
- Made of break-resistant polycarbonate
- Lid available separately
- Dishwasher safe



Clear(07)

| Prod No | Description | Glass Rack | Color | Pack |
|---|----------------------------|------------|-------|------|
| Crystalite Polycarbonate Pitchers | | | | |
| 5583 Δ ♦ | 48 oz Crystalite Pitcher | RF | 07 | 6 ea |
| 5587 Δ ♦ | 60 oz Crystalite Pitcher | RF | 07 | 6 ea |
| Élan Polycarbonate Pitcher & Lid | | | | |
| 5570 ♦ | 58 oz Élan Pitcher | RF | 07 | 6 ea |
| 5573 ♦ | Clear Lid for Élan Pitcher | — | 07 | 6 ea |

NSF Listed products are designated with a Δ and may be prefixed with an N

♦ California Residents: Bisphenol A **WARNING:** See appendix A on page 1

The look of recycled glass, the durability of Tritan plastic.

Mingle

- The look and feel of recycled glass drinkware
- Tritan offers durability that withstands the heavy use in your venue
- Durable Tritan is break and craze-resistant
- Stain resistant
- BPA Free
- NSF Listed; dishwasher safe
- Two-year limited warranty



Coordinating drinkware page 38

Stainless Steel Pitchers

- The look of silver, with the durability of stainless steel
- 18-8 stainless steel with mirror-polished finish
- Contoured lip to help control flow and prevent drips
- Hollow tubular handle
- Handwashing recommended



| Prod No | Description | Glass Rack | Color | Pack |
|---------------------------------|-----------------------------------|------------|------------|------|
| Mingle Pitcher | | | | |
| MIN5443 Δ | 74 oz Pitcher | — | 02, 15, 18 | 4 ea |
| Stainless Steel Pitchers | | | | |
| 609270 | 2 qt Stainless Steel Bell Pitcher | RTP | — | 1 ea |
| 609273 | 3 qt Stainless Steel Bell Pitcher | RTP | — | 1 ea |

NSF Listed products are designated with a Δ and may be prefixed with an N



DISPOSABLE LIDS

Lids

- Carlisle Disposable Lids are a green solution that saves you money
- Lower your disposable costs when you replace your disposable kid's cups with reusable Carlisle Tumblers and Disposable Lids
- Snug fitting lids fit a variety of Carlisle Tumblers and are slotted for use with straws
- Use for room service applications or anywhere you want to avoid spills
- Lids are packed 1,000 per case



In addition to the disposable lids listed here, Carlisle | Dinex offers a large selection of disposable lids for Carlisle and non-Carlisle tumblers. See our Dinex catalog at www.dinex.com for a complete listing, or contact your local Dinex sales representative for more information.



1110L with 43648

43635L with 43635

5506L with 5506

1110L with 1110

5812L with 5812

Translucent(30)

| Prod No | Description | Color | Pack |
|------------------------|---|-------|------|
| Disposable Lids | | | |
| 5810L | Fits 10 oz Louis Tumbler 5810 | 30 | 1 cs |
| 5812L | Fits 12 oz Louis Tumbler 5812 | 30 | 1 cs |
| 5822L | Fits 22 oz Louis Tumbler 5822 | 30 | 1 cs |
| 5212L | Fits 12 oz Stackable Tumbler 5212, 12 oz Crystalon SAN Tumbler 4012 and 12 oz Crystalon PC Tumbler 4033 | 30 | 1 cs |
| 5109L | Fits 9.5 oz Stackable PC Tumbler 5109, 8 oz Carlisle Mug 43066 | 30 | 1 cs |
| 5506L | Fits 9.5 oz Stackable Tumbler 5506 | 30 | 1 cs |
| 1110L | Fits 10 oz Bistro Tumbler 1110 and 8 oz Lorraine Tumbler 43648 | 30 | 1 cs |
| 63910L | Fits 10 oz Cambro® Tumbler NT10* | 30 | 1 cs |
| 63912L | Fits 12 oz Cambro® Tumbler NT12* | 30 | 1 cs |
| 52412L | Fits 12 oz Cambro® Tumbler LT12* | 30 | 1 cs |

*Cambro® is a registered trademark of Cambro® Manufacturing Company; Carlisle is not associated in any way with Cambro® Manufacturing Company



CARLISLE
FOODSERVICE PRODUCTS

PRACTICAL
RUGGED
STYLISH
UNIQUE
**TABLETOP
ACCESSORIES**



*Complete your tabletop setting in style with
Carlisle's versatile accessories offering.*





RAMEKINS

Carlisle has a ramekin for every application. Ramekins are offered in **high-quality melamine** designed to last. **The perfect addition to your hardworking tableware.**

Straight Sided Ramekins

- Melamine ramekins are safe for temperatures up to 212°F
- A modern take on a traditional product
- Use for sauces, condiments and mini desserts
- Ramekins stack for easy storage and space savings
- NSF Listed; dishwasher safe



Oval Ramekins

- Heavy-weight melamine ramekins are perfect for sauces, condiments, finger foods, mini desserts, etc.
- Oval shape is great for pouring dressings and sauces
- Wide design makes dipping easier
- NSF Listed; dishwasher safe



Square Melamine Ramekins

- Made of sturdy, break-resistant melamine
- 2 oz square ramekins available in single and double sizes
- Ramekins are stackable and can be used as a set for a variety of dipping sauces or individually for soy sauce and other condiments
- Safe for temperatures up to 212°F
- NSF Listed; dishwasher safe



| Prod No | Description | Color | Pack |
|---------------------------------|-----------------------------|-------------|-------|
| Straight Sided Ramekins | | | |
| 410 Δ | 2 oz Straight Sided Ramekin | 02, 03, 42 | 48 ea |
| 412 Δ | 3 oz Straight Sided Ramekin | 02, 03, 42 | 48 ea |
| 414 Δ | 4 oz Straight Sided Ramekin | 02, 03, 42 | 48 ea |
| Oval Ramekins | | | |
| S310 Δ | 2 oz Oval Ramekin | 02, 03, 42 | 48 ea |
| S312 Δ | 3 oz Oval Ramekin | 02, 03, 42* | 48 ea |
| S314 Δ | 4 oz Oval Ramekin | 02*, 03, 42 | 48 ea |
| Square Melamine Ramekins | | | |
| 0860 Δ | 2 oz Square Ramekin | 02, 03 | 48 ea |
| 0862 Δ | Double 2 oz Square Ramekin | 02, 03 | 24 ea |

NSF Listed products are designated with a Δ and may be prefixed with an N

* Color available by special order only



Japanese Style Ramekin

- Made of sturdy, break-resistant melamine
- 2 oz ramekins are styled with an Asian flare
- Heavy-weight design has the look and feel of ceramic or glass
- Ramekins are stackable and can be used for wasabi, ginger or a variety of dipping sauces
- Safe for temperatures up to 212°F
- NSF Listed; dishwasher safe



Scalloped Melamine Ramekins

- Made of thick-walled, heavy-weight melamine
- Stylish design coordinates with our dinnerware and display pieces
- Serves sauces, butter, salad dressings, salsa, etc.
- NSF Listed; dishwasher safe



Melamine Butter Dish

- Ideal for small portions of butter, wasabi or other condiments
- Wide mouth gives the illusion of a larger portion
- Heavy-weight sides have the look and feel of ceramic or glass
- Unique look is perfect for both casual and upscale dining or even pre-portioning in buffet and catering applications
- NSF Listed; dishwasher safe



| Prod No | Description | Color | Pack |
|-------------------------------|-----------------------------|-------------|-------|
| Japanese Style Ramekin | | | |
| 0864 Δ | 2 oz Japanese Style Ramekin | 02, 03 | 48 ea |
| Scalloped Ramekins | | | |
| 43942 Δ | 1 oz Scalloped Ramekin | 02, 03*, 42 | 48 ea |
| 43943 Δ | 2 oz Scalloped Ramekin | 02, 03, 42* | 48 ea |
| 43944 Δ | 3 oz Scalloped Ramekin | 02, 03 | 48 ea |
| Melamine Butter Dish | | | |
| 0855 Δ | 1 oz Melamine Butter Dish | 02 | 48 ea |

NSF Listed products are designated with a Δ and may be prefixed with an N

* Color available by special order only



RAMEKINS

Melamine Ramekins

- Thick-walled, heavy-weight melamine is perfect for serving sauces, butter, salad dressing, salsa, etc.
- NSF Listed; dishwasher safe



Salsa Dishes

- Carlisle salsa dishes are available in a variety of sizes, weights and materials
- Designed to accommodate dipping large chips or appetizers
- Deep salsa bowl has 8 oz capacity, perfect for serving salsa, cheese sauce, soups and other sauces

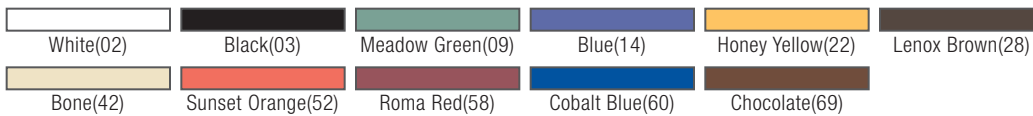

| Prod No | Description | Color | Pack |
|--------------------------|---------------------------------|---|-------|
| Melamine Ramekins | | | |
| S277 Δ | 1.75 oz Smooth Ramekin | 42 | 48 ea |
| S275 Δ | 1.5 oz Smooth Ramekin | 02, 03, 09, 14, 22, 42, 52, 60 | 48 ea |
| 0852 Δ | 2 oz Smooth Ramekin | 02, 03, 09, 14, 22, 42, 52, 58, 60, 69, | 72 ea |
| S280 Δ | 3 oz Smooth Ramekin | 02, 03, 42, 52, 58, 60, 69 | 48 ea |
| S285 Δ | 4 oz Smooth Ramekin | 02, 03, 09, 14, 22, 42, 52, 58, 60, | 48 ea |
| S286 Δ | 6 oz Smooth Ramekin | 02, 03, 42, 60, 69 | 48 ea |
| S279 Δ | 2 oz Fluted Ramekin | 02, 03, 42, 60 | 48 ea |
| S282 Δ | 3 oz Fluted Ramekin | 02, 03, 42, 60, 69 | 48 ea |
| S287 Δ | 4 oz Fluted Ramekin | 02, 03, 42, 60, 69 | 48 ea |
| Salsa Dishes | | | |
| 0873 Δ | 3 oz Melamine Molcajete Ramekin | 03 | 48 ea |
| 0878 Δ | 8 oz Melamine Molcajete Ramekin | 03 | 48 ea |
| 43125 | 5 oz SAN Salsa Dish | 60 | 48 ea |
| 4553 | 8 oz Melamine Deep Salsa Bowl | 28 | 36 ea |
| 0875 Δ | 5 oz Melamine Salsa Dish | 02, 03, 42, 60 | 48 ea |

NSF Listed products are designated with a Δ and may be prefixed with an N

Ramekins & Sauce Cups

- Perfect for individual service of butter, salsa, condiments, sauce
- Made of durable, break-resistant SAN
- Available in four distinct styles
- 0362, 0843, 0844, 0845, 2500: NSF Listed; dishwasher safe



Stainless Steel Ramekin & Sauce Cup

- Rust-free, 18-8 stainless provides durable, easy care service
- Dishwasher safe



SAN Ramekins

- Economical SAN ramekins serve sauces, butter, salad dressings, salsa, etc.
- Stackable design for easier storage
- Dishwasher safe



| Prod No | Description | Color | Pack |
|----------------------------------|--|------------|--------|
| Ramekins & Sauce Cups | | | |
| 0362 Δ | 2.5 oz Standard Ramekin | 02, 07, 28 | 48 ea |
| 0843 Δ | 1 oz Fluted Ramekin | 02 | 48 ea |
| 0844 Δ | 2 oz Fluted Ramekin | 02, 07 | 48 ea |
| 0845 Δ | 4.5 oz Fluted Ramekin | 02, 07, 28 | 48 ea |
| 2500 Δ | 2.5 oz SAN Sauce Cup | 07 | 72 ea |
| 0820 | 2.75 oz Oyster Sauce Cup | 07 | 144 ea |
| 0830 | 1 oz Soufflé Cup | 07 | 144 ea |
| 0831 | 2.5 oz Soufflé Cup | 07 | 144 ea |
| 602400 | 1.5 oz Stainless Steel Classic Ramekin | — | 144 ea |
| 602500 | 2.5 oz Stainless Steel Classic Sauce Cup | — | 144 ea |
| SAN Ramekins | | | |
| 43121 | 1.5 oz Smooth Ramekin | 42 | 48 ea |
| 43122 | 2 oz Smooth Ramekin | 03 | 48 ea |
| 43123 | 3 oz Smooth Ramekin | 03, 42 | 48 ea |
| 43126 | 6 oz Smooth Ramekin | 03, 42, 60 | 48 ea |

NSF Listed products are designated with a Δ and may be prefixed with an N



COFFEE SERVICE

Sugar Caddies

- Merchandiser caddy has pockets for salt and pepper shakers plus sign clip
- NSF Listed; dishwasher safe



Creamer/Pitchers

- Stain-resistant creamers and pitchers can be used for syrup, cream, salad dressings, sauces, etc
- Easy-pour, no-drip lip design
- Made of dishwasher safe SAN; safe for temperatures from 0° to 180°F
- 4560 is NSF Listed



Cheese Shaker/Sugar Pourer

- Popular 12 oz size is made of durable, break-resistant SAN
- Threaded lip fits standard shaker or pourer caps

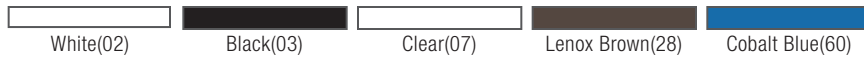

| Prod No | Description | Color | Pack |
|--|---------------------------------------|--------------------|-------|
| Caddies, Pitchers & Pourers | | | |
| 4549 Δ | Crystalite Caddy (holds 20 packets) | 07 | 24 ea |
| 4550 Δ | Standard Caddy (holds 20 packets) | 02, 03, 07, 28, 60 | 24 ea |
| 4551 Δ | Merchandiser Caddy (holds 50 packets) | 03 | 24 ea |
| 4560 Δ | 2 oz Syrup Pitcher/Creamer | 02, 07 | 36 ea |
| 4563 | 3 oz Creamer/Pitcher | 02 | 36 ea |
| 3316 | Base with Pourer Top | 07 | 36 ea |
| 3319 | Base with Shaker Top | 07 | 36 ea |

NSF Listed products are designated with a Δ and may be prefixed with an N



J-Jars

- Durable jars are ideal for condiments of all types: jelly, jam, mustard, sauces, etc.
- Chrome-plated caddy offers beauty and strength
- NSF Listed



4575

Bud Vases

- Let flowers add the finishing touch to any tabletop
- Beautiful, break-resistant acrylic with heavy base to prevent messy spills



Clear(07)

| Prod No | Description | Color | Pack |
|------------------|---------------------|-------|-------|
| J-Jars | | | |
| 4575 Δ | 8 oz J-Jar with Lid | 07 | 24 ea |
| Bud Vases | | | |
| 4650 | 4" Acrylic Bud Vase | 07 | 12 ea |
| 4651 | 6" Acrylic Bud Vase | 07 | 12 ea |

NSF Listed products are designated with a Δ and may be prefixed with an N



SERVING BASKETS

Woven Baskets

- Handmade natural beauty combined with easy care
- Resistant to mold and mildew
- Microwave safe
- Dishwasher safe



Munchie Baskets™

- Excellent for serving a deli sandwich or a specialty appetizer
- Stackable and dishwasher safe
- Custom decorating available; see page 334



The industry's only basket with custom imprinting

Basket Server

- Break-resistant SAN baskets can be used for holding tall items like bread sticks or can be used as an ice bucket for table or room service
- Safe for use in temperatures from 0° to 180°F
- Dishwasher safe



| Prod No | Description | Color | Pack |
|------------------------|------------------------------------|--------|-------|
| Woven Baskets | | | |
| 6550 | 9" x 6.25" Small Oval Basket | 03, 25 | 6 ea |
| 6551 | 11.75" x 7.75" Medium Oval Basket | 03, 25 | 6 ea |
| 6552 | 11.5" x 8.5" Rectangle Oval Basket | 03, 25 | 6 ea |
| 6553 | 9" Small Round Basket | 03, 25 | 6 ea |
| Munchie Baskets | | | |
| 44030 | 7.38" x 5.38" Munchie Basket | 03, 05 | 24 ea |
| 44031 | 10.38" x 8" Munchie Basket | 03, 05 | 12 ea |
| Basket Server | | | |
| 356 | 6.5" Basket, 3 qt | 07 | 6 ea |



WeaveWear™ Baskets & Platter

- For serving chips, fries, sandwiches, finger foods or kids' meals
- Wicker weave pattern exterior with smooth, easy to clean interior
- Safe alternative to wicker and plastic coated wire
- Made of durable FDA grade polypropylene
- Vented base on 6528 and 6529 allows for drainage and reduces condensation
- 6528, 6527, 6529 feature a wide diameter and raised bottom design to create a unique presentation for your signature sandwich, appetizer or specialty item
- Dishwasher safe



Wicker Look Basket

- Elegant baskets for serving chips, fries, sandwiches, finger foods or kids' meals
- Design features a detailed wicker weave patterned exterior
- Smooth, easy-to-clean interior
- Made of durable, scratch-resistant polycarbonate



Bread & Bun Basket

- Extremely economical basket is great for all types of food such as sandwiches, fries, ribs, chips or breads



| Prod No | Description | Color | Pack |
|--|---|----------------|-------|
| WeaveWear Baskets & Platter | | | |
| 6504 | 9" x 6.25" Oval WeaveWear Basket | 03, 05, 09, 67 | 12 ea |
| 6524 | 9" Round WeaveWear Basket | 03, 05, 09, 67 | 12 ea |
| 6526 | 12" Round WeaveWear Basket | 03, 05, 09, 67 | 12 ea |
| 6528 | 9.25" Round WeaveWear Basket with Drain Slots | 03 | 12 ea |
| 6527 | 10.38" Round WeaveWear Platter | 03, 31 | 12 ea |
| 6529 | 11" Round WeaveWear Basket with Drain Slots | 03 | 12 ea |
| Wicker Look Basket | | | |
| WB965 ♦ | 9.44" x 6.63" Oval Basket | 07 | 6 ea |
| Bread & Bun Basket | | | |
| 0333 | 9.25" x 6" Oval Basket | 03, 05 | 36 ea |

♦ California Residents: Bisphenol A **WARNING:** See appendix A on page 1



TORTILLA SERVERS

Interlocking base & lid design allows for stacking several tortilla servers at one time

Tortilla Servers

- Lid has easy-grip, recessed handle
- Durable polycarbonate tortilla servers withstand temperatures up to 212°F
- Polypropylene servers are easy-clean, long-lasting and economical; withstand temperatures up to 190°F
- NSF Listed; dishwasher safe

US Patent No. D-331351



Salsa and Molcajete Dishes on page 58



| Prod No | Description | Color | Pack |
|---|--------------------------|----------------|-------|
| Interlocking Tortilla Servers & Lids | | | |
| 0470 ▲◆ | 7.5" PC Tortilla Server | 03, 05, 60 | 24 ea |
| 0475 ▲◆ | 7.5" PPY Tortilla Server | 03, 05, 28, 42 | 24 ea |

NSF Listed products are designated with a ▲ and may be prefixed with an N

◆ California Residents: Bisphenol A **WARNING:** See appendix A on page 1



Aztec Tortilla Servers

- Unique Aztec design works well in any traditional Mexican or Tex-Mex restaurant
- 8" and 12" servers available in a lift off lid model
- 7" server available with hinged lid for easy one handed access
- Thick walled polypropylene material helps keep tortillas warm for table service
- Microwaveable, safe for temperatures up to 150°F
- Servers are stackable
- NSF Listed; dishwasher safe



| Prod No | Description | Color | Pack |
|--|------------------------------|------------|-------|
| Aztec Tortilla Servers & Lids | | | |
| 0710 Δ | 7" Hinged Tortilla Server | 03, 29 | 12 ea |
| 0713 Δ | 8" Lift Off Tortilla Server | 03, 29 | 12 ea |
| 0717 Δ | 12" Lift Off Tortilla Server | 03, 08, 29 | 6 ea |
| 0700 Δ | 7" Hinged Replacement Lid | 03, 29 | 12 ea |
| 0703 Δ | 8" Replacement Lid | 03, 08 | 12 ea |
| 0707 Δ | 12" Replacement Lid | 03, 08, 29 | 6 ea |

NSF Listed products are designated with a Δ and may be prefixed with an N



SERVING TRAYS & ACCESSORIES

Round Serving Trays

- Serving Trays are perfect for bar service or individual meals including salads, sandwiches or burgers
- Perfect size for iced seafood platters
- Made of heavy-duty, break-resistant melamine
- NSF Listed; dishwasher safe



1300



Roll-Top Covered Dishes

- Multi-purpose roll-top dishes are perfect for serving sugar, candies, sauces or dressings
- High-polish 18-8 stainless steel
- Handwashing recommended

609132



609131



609133



| Prod No | Description | Color | Pack |
|--------------------------------|----------------------------------|------------|-------|
| Serving Trays | | | |
| 1300 Δ | 13" x 1.5" Melamine Serving Tray | 01, 02, 60 | 12 ea |
| Roll-Top Covered Dishes | | | |
| 609131 | 10 oz Roll-Top Covered Dish | — | 12 ea |
| 609132 | 14 oz Roll-Top Covered Dish | — | 12 ea |
| 609133 | 30 oz Roll-Top Covered Dish | — | 1 ea |

NSF Listed products are designated with a Δ and may be prefixed with an N

Dual Booster Seats

- Two-sided seat offers a choice of heights
- Extra-strong, one-piece molded design with wide square base for better stability
- Anti-skid pads on both sides prevent sliding

Booster Seat With Safety Strap

- Strap secures to chair to increase child safety
- Snap clasp and adjustable strap for use behind chair back or under seat



7111-4



| Prod No | Description | Color | Pack |
|---------------------------------------|--------------------------------|--------------------|-------|
| Dual Booster Seat | | | |
| 7110 | Booster Seat | 01, 03, 05, 06, 08 | 4 ea |
| Booster Seat with Safety Strap | | | |
| 7111-4 | Booster Seat with Safety Strap | 01, 03 | 4 ea |
| Replacement Strap | | | |
| 7112 | Replacement Strap | 03 | 12 ea |

Note: 7110, 7111-4 can ship UPS/FedEx Ground at oversize cost



CARLISLE
FOODSERVICE PRODUCTS

BEAUTIFUL
QUALITY
ELEGANT
PROTECTIVE
HANDMADE
MARKO
TABLE
COVERINGS

No room is complete without the finishing touches and setting. An excellent table begins with quality products. Marko offers the finest quality of textiles to help you achieve that perfect look.



IN-STOCK PROGRAM

Includes the **most requested** Marko table coverings, napkins, skirting and accessories **available as stocked items**. With Carlisle FoodService, you can count on Marko to be there for you.

Embrace™

- Polyester/Spandex fabric embraces the table providing a snug fit and eliminating wrinkles
- True four-way stretch fabric easily expands over most tables for a uniform look
- Reinforced plastic feet come standard and are sewn in to hold the cover firmly in place
- Feet protect linens from contact with rough floor surfaces and help prevent ripping and soiling
- Serving as a functional linen, Embrace is perfect for beverage dispensers and waste receptacles
- Easy to install; no pressing or dry cleaning required
- Machine washable and dryable for easy care

EMB5026HT30



EMB5026TLC23

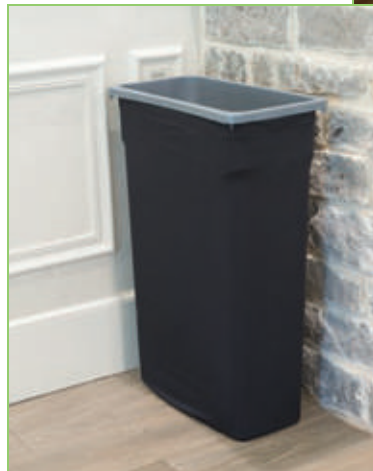

Embrace



Black(014)

| Product No | Description | Finished Size | Color | Pack |
|----------------|---|-----------------|-------|------|
| Embrace | | | | |
| EMB5026RT830 | Embrace Rectangular Cover | 96" x 30" x 30" | 014 | 1 ea |
| EMB5026AC830 | Embrace Arch Cut Cover | 96" x 30" x 30" | 014 | 1 ea |
| EMB5026RT630 | Embrace Rectangular Cover | 72" x 30" x 30" | 014 | 1 ea |
| EMB5026AC630 | Embrace Arch Cut Cover | 72" x 30" x 30" | 014 | 1 ea |
| EMB5026R72 | Embrace Round Table Cover | 72" | 014 | 1 ea |
| EMB5026R24 | Embrace Round Table Cover | 24" | 014 | 1 ea |
| EMB5026HT30 | Embrace Hi-Top Round Table Cover | 30" | 014 | 1 ea |
| EMB5026TLC23 | Embrace 23 gal TrimLine Cover | — | 014 | 1 ea |
| EMB5026WC35 | Embrace 32 gal Waste Container Cover | — | 014 | 1 ea |
| EMB5026WC44 | Embrace 44 gal Waste Container Cover | — | 014 | 1 ea |
| EMB5026WC55 | Embrace 55 gal Waste Container Cover | — | 014 | 1 ea |
| EMB5026BS10 | Embrace 10 gal Beverage Server Cover | — | 014 | 1 ea |
| EMB5026BS5 | Embrace 5 gal Beverage Server Cover | — | 014 | 1 ea |
| EMB5026BS25 | Embrace 2.5 gal Beverage Server Cover | — | 014 | 1 ea |
| EMB5026LTRC | Embrace Tray Stand Cover, >30" | 30"+ | 014 | 1 ea |
| EMB5026TRC | Embrace Tray Stand Cover, <30" | 30" | 014 | 1 ea |
| EMB5026TT27014 | Embrace Tray Cover (Fits 27" x 22" Oval Tray) | 28" x 33" | 014 | 1 ea |

SoftWeave™ Spun Filament Polyester Tablecloths & Napkins

- Spun filament polyester fabric (blend of polyspun and poly filament) provides the look and feel of cotton without fading or shrinking
- Excellent resistance to pilling and snagging
- Absorbs liquids quickly
- Advanced stain release technology allows you to wash at only 120°F water temperature and use half the detergent
- Aspen Damask, a Marko exclusive, has a high definition pattern that offers a bolder contrast



SoftWeave Tablecloth

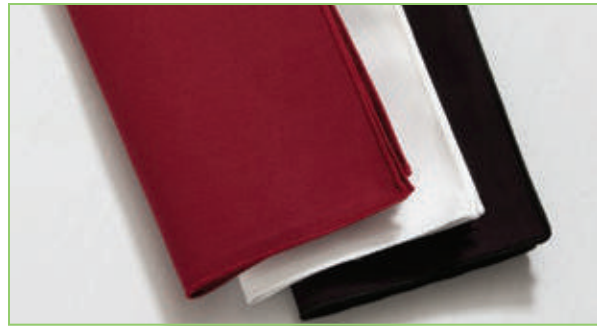

SoftWeave Napkins

SoftWeave



Aspen Damask

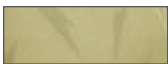

Sage(147)

Classic Twill

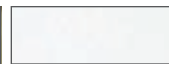

White(010)

| Prod No | Description | Dimensions | Color | Pack |
|---------------------------|-----------------------------------|------------|---------------|------|
| Fabric Tablecloths | | | | |
| 53785252SM | SoftWeave Square Tablecloth | 52" x 52" | 010, 014, 046 | 1 ea |
| 537852AITM | SoftWeave Rectangular Tablecloth | 52" x 108" | 010, 046 | 1 ea |
| 53785454SM | SoftWeave Square Tablecloth | 54" x 54" | 010 | 1 ea |
| 537854AUTM | SoftWeave Rectangular Tablecloth | 54" x 120" | 010 | 1 ea |
| 53785858SM | SoftWeave Square Tablecloth | 58" x 58" | 010 | 1 ea |
| 53787272SM | SoftWeave Square Tablecloth | 72" x 72" | 010 | 1 ea |
| 537876RM | SoftWeave Round Tablecloth | 76" | 010 | 1 ea |
| 537890RM | SoftWeave Round Tablecloth | 90" | 010 | 1 ea |
| 53935252SM | SoftWeave Aspen Damask Tablecloth | 52" x 52" | 147 | 1 ea |

Classic Twill Skirting and Accessories

- Minimal fading, shrinking and wrinkling
- 100% Polyester; machine wash and dry
- Flame retardant
- Shirred skirts come complete with hook and loop tape and 550PC clips



Classic Twill Skirting w/ SoftWeave Tablecloth

Clips

Marko offers specifically designed clips to fit a variety of table edges. From our lifetime guarantee on our metal clips to our polycarbonate plastic clips, Marko has everything you need to pull your look together.

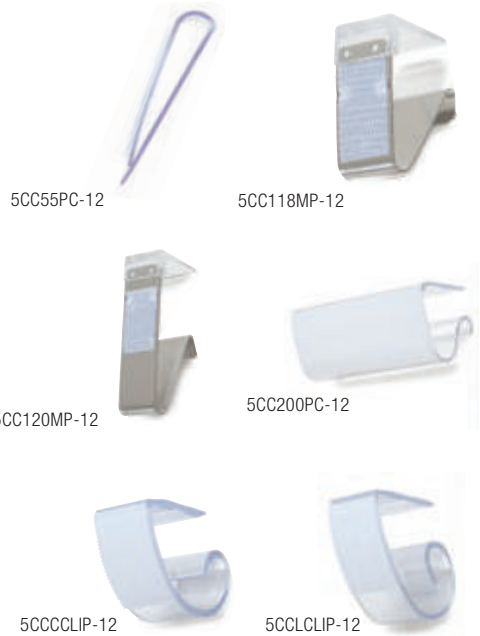

Classic Twill



White(010)

Black(014)

| Prod No | Description | Dimensions | Color | Pack |
|-----------------------------|---|-------------------|----------|-------|
| Fabric Skirting | | | | |
| 5024CE29AF | Classic Twill Shirred Pleat Skirting w/Velcro Header & 24 Clips | 13' | 010, 014 | 1 ea |
| 5024EG29AF | Classic Twill Shirred Pleat Skirting w/Velcro Header & 31 Clips | 17.5' | 010, 014 | 1 ea |
| 5024FW29AF | Classic Twill Shirred Pleat Skirting w/Velcro Header & 38 Clips | 21' | 010, 014 | 1 ea |
| Skirting Accessories | | | | |
| | | Table Edge | | |
| 5CC55PC-12 | Overlock & Valance Clip, Hook & Loop Header | 1/2" | — | 12 ea |
| 5CC118MP-12 | 12 Metal Skirting Clip, Hook & Loop Header | 3/8" - 1-1/4" | — | 12 ea |
| 5CC120MP-12 | 12 Metal Skirting Clip, Hook & Loop Header | 1-1/4" - 2-1/4" | — | 12 ea |
| 5CC200PC-12 | 12 Plastic Skirting Clip, Hook & Loop Header | 3/8" - 3/4" | — | 12 ea |
| 5CCCCLIP-12 | 12 Plastic Skirting Clip, Hook & Loop Header | 3/4" - 2" | — | 12 ea |
| 5CCLCLIP-12 | 12 Large Plastic Skirting Clip, Hook & Loop Header | 1-1/2" - 2-1/2" | — | 12 ea |

Bistro Striped Napkins

- Popular farm-to-table look
- 100% SoftWeave fabric
- Yarn dyed stripe stays true to color without fading or bleeding
- Designed to be washed with bleach



Bistro Striped Napkins

SoftWeave



Bistro Striped

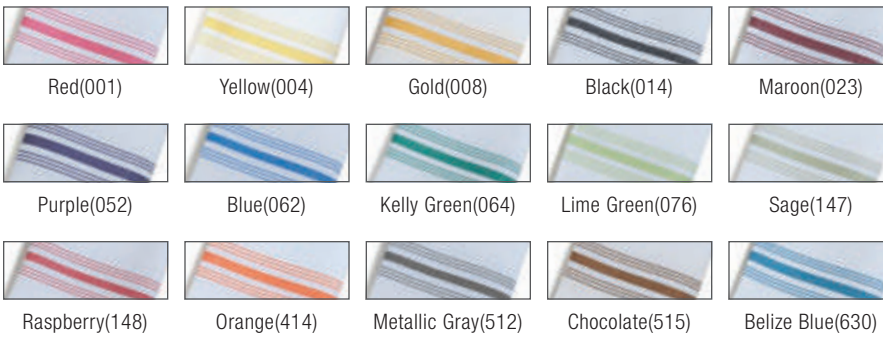

Aspen Damask Color



| Product No | Description | Finished Size | Color | Pack |
|-----------------------|---------------------------------|---------------|---|-------|
| Fabric Napkins | | | | |
| 53781717NM | SoftWeave Napkins | 17" x 17" | 010, 014, 046 | 12 ea |
| 53782020NM | SoftWeave Napkins | 20" x 20" | 010, 014, 046 | 12 ea |
| 53771822NH | SoftWeave Bistro Striped Napkin | 18" x 22" | 001, 004, 008, 014, 023, 052, 062, 064, 076, 147, 148, 414, 512, 515, 630 | 12 ea |
| 53931717NM | Aspen Damask Napkins | 17" x 17" | 147 | 12 ea |

Vinyl Table Coverings

Vative Series

- Premium vinyl line with the elegance and drape of fabric
- Heavy 6 gauge vinyl with polyester knit backing
- Flame retardant
- Easy care – simply wipe clean with a soft, damp cloth

Vative Glimmer Series

- Premium vinyl line with the elegance and drape of fabric; the “shimmering” color makes it perfect for weddings or upscale gatherings.
- Heavy 6 gauge vinyl with polyester knit backing
- Flame retardant
- Easy care – simply wipe clean with a soft, damp cloth

Classic Series

- Economical 4 gauge vinyl with polyester backing
- Flame retardant
- Easy care – simply wipe clean with a soft, damp cloth



Classic™ Series (Red Check)



Clear Vinyl

Clear Vinyl Rolls

- Protect your tabletops and expensive fabric tablecloths from moisture and spills
- BPA free
- Flexible material withstands repeated bending and pressure
- Use for multiple meal services – reduce laundry expenses and employee labor
- Excellent choice for long- or short-term care facilities with group dining environments
- A practical choice for large-scale craft projects in schools, daycares or DIY classes



Pan Rack Cover

Vative Series



Stone(382)

Vative Glimmer

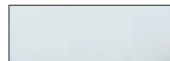

Metallic Silver(625)

Classic Check



Red(001)

Clear Vinyl Rolls



Clear(018)

Misc. Vinyl



Clear(018)

| Product No | Description | Finished Size | Color | Pack |
|--------------------------|--------------------------------------|---------------|-------|------|
| Vinyl Tablecloths | | | | |
| 59035252SM ♦ | Vative Series | 52" x 52" | 382 | 1 ea |
| 59085252SM ♦ | Vative Series Glimmer Series | 52" x 52" | 625 | 1 ea |
| 51515252SM ♦ | Classic Series | 52" x 52" | 001 | 1 ea |
| Clear Vinyl Rolls | | | | |
| 53135054L | Clear Vinyl Roll, 4 Gauge, 54" Wide | 50 yd | 018 | 1 ea |
| 53182554L | Clear Vinyl Roll, 8 Gauge, 54" Wide | 25 yd | 018 | 1 ea |
| 53201554L | Clear Vinyl Roll, 12 Gauge, 54" Wide | 15yd | 018 | 1 ea |
| Misc. Vinyl | | | | |
| 5675CL ♦ | Pan Rack Cover | N/A | 018 | 1 ea |

♦ California Residents: Di(2-ethylhexyl)phthalate (DEHP) **WARNING:** See appendix B on page 1

IN-STOCK PROGRAM DETAILS

Marko In-Stock items **can be combined with any foodservice product order** to meet freight minimums. Combined product orders will **ship together** from one distribution center

Return Policy:

- In-Stock items will offer the same 90-day return policy as foodservice
- All returns must be in original standard packs and unused, saleable condition
- See Carlisle Terms & Conditions for a complete list of requirements

Additional Ordering Information:

- In-Stock items can be combined on one purchase order with foodservice products
- In-Stock items can be combined with made-to-measure items
- Combined orders of In-stock items and made-to-measure items will ship together upon completion of the made-to-measure items

Note:

- Carlisle reserves the right to add or remove items from our stocking program at any time
- Made-to-measure items cannot be combined with foodservice orders

For more information, please contact your sales representative



CALCULATING TABLECLOTH SIZE

DROP LENGTHS

- A standard drop of 8" is recommended for all tables. That is the amount of fabric that will hang over each side of the table.
- Some operators might want a slightly shorter or longer drop. In most cases 6" is the shortest drop recommended. An 8" drop will let both fabric and vinyl tablecloths drape easily.

Basic Table Sizing

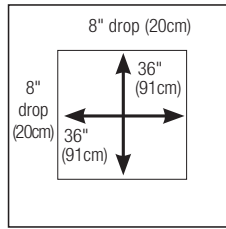

Square Or Rectangular Tables

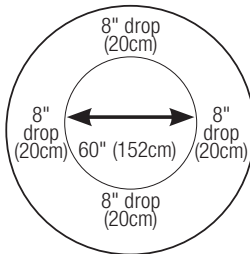

Round Tables

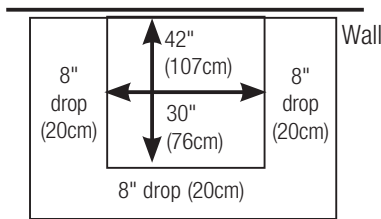

Booth Tables

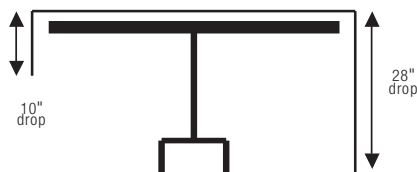

Conference Cloth

For any square, rectangular or round table, simply take the width of the tabletop, add your Drop to EACH Side and that's the size Tablecloth you need:

EXAMPLE for a 36" Square table:

| | | |
|----------------------------|---|------------------------------|
| 36" wide table | x | 36" wide table |
| +16" (8" drop x's 2 sides) | x | +16" x (8" drop x's 2 sides) |
| 52" wide cloth | x | 52" wide cloth |

or

EXAMPLE for a 60" round table:

| |
|--------------------|
| 60" round table |
| +16" (8" drop x 2) |
| 76" round cloth |

or

EXAMPLE for a 30" x 42" booth table:

| | | |
|----------------------------|---|--------------------|
| 30" wide table | x | 42" long table |
| +16" (8" drop x's 2 sides) | x | + 8" (drop 1 side) |
| 46" wide cloth | x | 50" long cloth |

Please specify Booth Set Up when ordering

Conference Cloths

Conference Cloths are used to cover Conference Tables. Similar to a Head Table at a banquet, they should have an 8" or 10" drop on the open side and 28" fall, almost to the floor, on the other sides. A typical 6' Conference Table:

| | | |
|----------------------------|---|---------------------------|
| 18" wide table | x | 72" long table |
| +38" (10" drop + 28" drop) | x | +56" (28" drop x 2 sides) |
| 56" wide cloth | x | 128" long cloth |

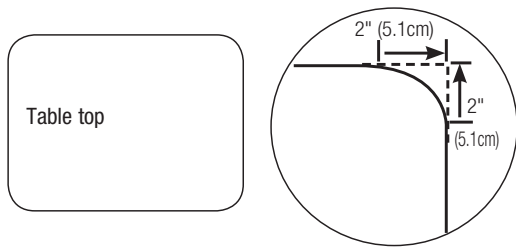
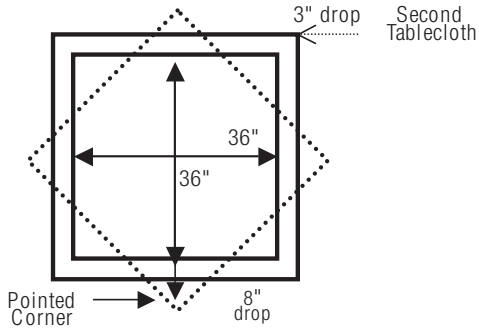
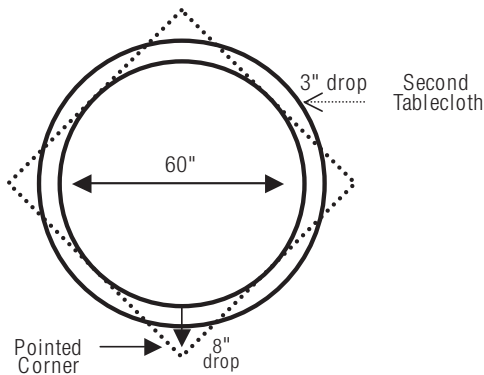

Table with radius corners



Square Or Rectangular Table OVERLAY



Round Table Overlay



Fitted Tablecloths For Odd Shaped Corners

Marko offers Hat Box Corner form fitted tablecloths that have a continuous seam around the top edge of the table. If the corner radius of your table is greater than 2" the shape of the corner will be used. If the corner radius is less than 2" the corner will be made square. Contact your customer service representative if you have any questions regarding what type of tablecloth will work for you.

Table Toppers

Table Toppers cover the top of Skirted Banquet Tables. They follow the same rules as any other rectangular, square, or round tablecloth. They need to be the exact length, width, or circumference of the table PLUS the desired drop length added to EVERY side. Use the formulas on page 76 and this page to calculate size.

For common applications where the Banquet Table is going to be skirted all the way around, we recommend the standard 8" drop. For Head Tables where one side of the table is going to be left open (Skirted 3-sides with returns on the corners of the 4th side), some people like a slightly longer drop of 10". You should be careful of drops over 10", as the cloth may end up resting partially in patrons' laps. A quick look at the chair seat heights in the room will help you avoid this problem.

Table Toppers are placed first with the Clips for fastening the Skirting placed over them to hold the Topper in place. For a finished look, always recommend Table Padding for Banquet Tables.

Overlays

Overlays are placed on top of the Tablecloth on a dining table for a more formal, elegant presentation. There are two types:

- Pointed Corners: Square cloths that are set at a 45° angle on the table for the corners to hang over the side of the table
- Second Tablecloths: Exact size and shape as the table top with a 3" drop added to all sides

Embrace

For a more tailored fit, use this guide to measure and order your specific table coverings.

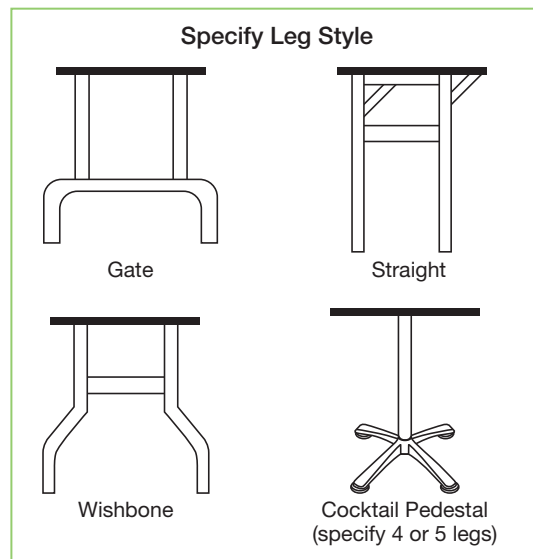



CARLISLE
FOODSERVICE PRODUCTS

STYLISH BREAK- RESISTANT CONTEMPO- RARY ELEGANT **DISPLAYWARE**

How you display your culinary creations is what brings your guests in. Carlisle has everything you need to provide an organized, attractive and safe food service environment.



MELAMINE DISPLAYWARE

Balsam displayware is your **ideal choice** for displaying prepared food in front of your guest.



Balsam™

- Withstands the rigors of commercial foodservice dishwasher use
- Maintains its appearance after one year of dishwasher testing
- Durable melamine is stain, scratch- and break-resistant, making it ideal for any foodservice operation
- Safe for temperatures up to 212°F
- NSF Listed; dishwasher safe



 Bavarian Cream(37)

| Prod No | Description | Color | Pack |
|---|------------------------------|-------|------|
| Balsam Displayware | | | |
| 55520 ▲ | 1" Deep Full Size Pan | 37* | 6 ea |
| 55522 ▲ | 2.5" Deep Full Size Pan | 37 | 6 ea |
| 55524 ▲ | 4" Deep Full Size Pan | 37 | 6 ea |
| 55526 ▲ | 1" Deep Half Long Size Pan | 37 | 6 ea |
| 55528 ▲ | 2.5" Deep Half Long Size Pan | 37 | 6 ea |
| 55530 ▲ | 4" Deep Half Long Size Pan | 37 | 6 ea |
| 55532 ▲ | 1" Deep Half Size Pan | 37* | 6 ea |
| 55534 ▲ | 2.5" Deep Half Size Pan | 37 | 6 ea |
| 55536 ▲ | 4" Deep Half Size Pan | 37 | 6 ea |
| 55538 ▲ | 1" Deep Third Size Pan | 37 | 6 ea |
| 55540 ▲ | 2.5" Deep Third Size Pan | 37 | 6 ea |
| 55542 ▲ | 4" Deep Third Size Pan | 37 | 6 ea |
| 55544 ▲ | 26 oz Angled Bowl | 37 | 6 ea |
| 55546 ▲ | 3 qt Angled Bowl | 37 | 6 ea |
| 55550 ▲ | 26 oz Square Bowl | 37 | 6 ea |

NSF Listed products are designated with a ▲ and may be prefixed with an N

* Color available by special order only

Customers respond to the presentation of prepared food. **Make your presentation irresistible** with our Flared Bowls. The shape and flare **draw the eye into the food.**

Flared Square Bowls

- Large display bowls coordinate with many other Carlisle pieces
- High quality, heavy-weight melamine
- Safe for temperatures up to 212°F
- NSF Listed; dishwasher safe



| Prod No | Description | Color | Pack |
|----------------------------|-----------------------------------|--------|------|
| Flared Square Bowls | | | |
| 33360 Δ | 5 qt, 11.75" Small Flared Bowl | 02, 03 | 4 ea |
| 33362 Δ | 8 qt, 13.75" Medium Flared Bowl | 02, 03 | 4 ea |
| 33364 Δ | 15.5 qt, 16.88" Large Flared Bowl | 02, 03 | 4 ea |

NSF Listed products are designated with a Δ and may be prefixed with an N

MELAMINE DISPLAYWARE

The **contemporary design of Rave is the versatile choice for your displays.** Rave suits many types of cuisines and the interesting shapes create a playful display that will **draw guests to your culinary offerings.**

Rave®

- Offers the look and feel of china without the replacement cost
- Bowls lock into pedestal for secure serving
- Skid-resistant feet
- Safe for temperatures up to 212°F
- Dishwasher safe



| Prod No | Description | Color | Pack |
|-------------------------|--------------------------------------|----------|-------|
| Rave Displayware | | | |
| 33310 | 7", 1.5 qt Rave Serving Bowl | 02, 03 | 6 ea |
| 33312 | 10", 4.5 qt Rave Serving Bowl | 02, 03 | 6 ea |
| 33314 | 12", 4.5 qt Rave Salad Bowl | 02, 03 | 6 ea |
| 33316 | 13", 2 qt Rave Starburst Bowl | 02*, 03* | 6 ea |
| 33318 | 15" Rave Bowl with Rim | 02* | 6 ea |
| 33320 | 10", 2.5 qt Rave Rectangular Platter | 02 | 6 ea |
| 33322 | 16" Rave Rectangular Platter | 02, 03 | 6 ea |
| 33324 | 23" Rave Rectangular Platter | 02, 03 | 6 ea |
| 33326 | 16" Rave Trapezoid Platter | 02, 03* | 6 ea |
| 33302 | 4" Rave Pedestal | 02* | 12 ea |

NSF Listed products are designated with a **Δ** and may be prefixed with an N

* Color available by special order only

The oversized scalloped platters are **perfect for display, deli and tabletop presentations.** This collection **easily coordinates with many other Carlisle pieces.**

Scalloped Platters

- High quality, heavy-weight melamine
- Safe for temperatures up to 212°F
- NSF Listed; dishwasher safe



Terra is a longtime Carlisle customer favorite! The **organic design and exceptional quality** make it popular for buffet and display case use.

Terra®

- Unique textured platters add depth
- Safe for temperatures up to 212°F
- NSF Listed; dishwasher safe



| Prod No | Description | Color | Pack |
|---------------------------|---|--------|-------|
| Scalloped Platters | | | |
| 7944 Δ | 19.5" x 13" Rectangular Small Scalloped Tray | 02, 03 | 4 ea |
| 7946 Δ | 22.5" x 14.5" Rectangular Medium Scalloped Tray | 02, 03 | 4 ea |
| 7948 Δ | 24.5" x 18.5" Rectangular Large Scalloped Tray | 02, 03 | 4 ea |
| Terra Displayware | | | |
| 44514 Δ | 14" Round Textured Platter | 02 | 12 ea |
| 44518 Δ | 18" Round Textured Platter | 02, 03 | 12 ea |
| 44520 Δ | 13.5" x 9.25" Rectangular Textured Platter | 03 | 4 ea |
| 44522 Δ | 15.5" x 11" Rectangular Textured Platter | 02, 03 | 4 ea |
| 44524 Δ | 18" x 12.5" Rectangular Textured Platter | 02 | 4 ea |

NSF Listed products are designated with a Δ and may be prefixed with an N

MELAMINE DISPLAYWARE

The Palette Designer series is **perfect for large food presentations.** We offer a **wide rim style that frames your food beautifully.**

Palette Designer Displayware®

- Combine with decorated Palette pieces for attention getting displays in the deli case or buffet line
- Break-resistant construction reduces replacement costs
- High quality, heavy-weight melamine
- Safe for temperatures up to 212°F
- NSF Listed; dishwasher safe

Wide Rim

- Use with displayware covers shown on the facing page



| Prod No | Description | Cover | Color | Pack |
|-------------------------------------|--------------------------------------|--------|--------|-------|
| Palette Designer Displayware | | | | |
| 43024 Δ | 12" Wide Rim Round Plate | 1994* | 02 | 12 ea |
| 44400 Δ | 12" Wide Rim Square Plate | 44400C | 02, 03 | 4 ea |
| 44402 Δ | 14", 4.5 qt Wide Rim Square Bowl | 44402C | 02, 03 | 4 ea |
| 44404 Δ | 15" Wide Rim Round Platter | 44404C | 02 | 4 ea |
| 44406 Δ | 19" Wide Rim Round Platter | — | 02, 03 | 4 ea |
| 44410 Δ | 17" X 13" Wide Rim Oval Platter | 44410C | 02, 03 | 4 ea |
| 44412 Δ | 21" X 15" Wide Rim Oval Platter | 44412C | 02, 03 | 4 ea |
| 44414 Δ | 14" X 10" Wide Rim Rectangle Platter | 44414C | 02, 03 | 4 ea |
| 44416 Δ | 17" X 13" Wide Rim Rectangle Platter | — | 02, 03 | 4 ea |
| 44418 Δ | 22" Wide Rim Salmon Platter | — | 02, 03 | 4 ea |

NSF Listed products are designated with a Δ and may be prefixed with an N
 *1994 Plate Cover can be found in the Dinnerware section of this catalog

Food Pans

- 2.5" and 4" deep pans can be turned over and used as display stands
- Combine with display covers shown below to create an attractive merchandising display
- NSF Listed; dishwasher safe



Palette Displayware Covers

- Designed to work with selected pieces of our Palette Displayware
- Clear polycarbonate covers are highly heat- and break-resistant
- Allows you to safely protect and transport dishes prepped in advance
- Stack for compact storage
- Dishwasher safe



| Prod No | Description | Cover | Color | Pack |
|---|--|--------|--------|-------|
| Palette Designer Displayware Food Pans | | | | |
| 44420 Δ | 1" D Full Size Food Pan, 20.75" x 12.75" | — | 02, 03 | 6 ea |
| 44422 Δ | 2.5" D Full Size Food Pan, 20.75" x 12.75" | — | 02, 03 | 6 ea |
| 44430 Δ | 1" D Half Size Food Pan, 12.75" x 10.38" | 44432C | 02 | 6 ea |
| 44432 Δ | 2.5" D Half Size Food Pan, 12.75" x 10.38" | 44432C | 02 | 6 ea |
| 44460 Δ | 1" D Third Size Food Pan, 12.75" x 6.87" | — | 02, 03 | 6 ea |
| 44462 Δ | 2.5" D Third Size Food Pan, 12.75" x 6.87" | — | 02 | 6 ea |
| Palette Designer Displayware Covers | | | | |
| 44410C \diamond | Cover for 17" x 13" Wide Rim Oval Platter | — | 07 | 12 ea |
| 44414C \diamond | Cover for 14" x 10" Wide Rim Rectangle Platter | — | 07 | 12 ea |
| 44432C \diamond | Cover for Half Size Food Pan | — | 07 | 12 ea |

NSF Listed products are designated with a Δ and may be prefixed with an N
 \diamond California Residents: Bisphenol A **WARNING:** See appendix A on page 1

MELAMINE DISPLAYWARE

These 6 versatile pieces coordinate beautifully with our **Epicure Dinnerware** pieces that are offered **on page 27**

Epicure® Displayware

- Stain- and scratch-resistant finish
- Made of dependable, impact-resistant melamine
- Safe for temperatures up to 212°F
- NSF Listed; dishwasher safe



Narrow rimmed platters provide a larger landscape for your food presentations. Carlisle offers **5 shapes and sizes** to give you the perfect size for your application.

Narrow Rimmed Displayware

- Rimmed style displayware in a variety of shapes
- Stain- and scratch-resistant finish
- Made of dependable, impact-resistant melamine
- Safe for temperatures up to 212°F
- NSF Listed; dishwasher safe



| Prod No | Description | Color | Pack |
|--|-------------------------------------|--------|-------|
| Epicure Displayware | | | |
| ARR240 ▲ | 46 oz, 9" Round Open Vegetable Bowl | 02 | 12 ea |
| 5933 ▲ | 32 oz, 8.25" Round Bowl | 02 | 24 ea |
| 43737 ▲ | 24 oz, 7.38" Footed Serving Bowl | 02, 03 | 12 ea |
| 43738 ▲ | 36 oz, 8.63" Footed Serving Bowl | 02 | 12 ea |
| 43739 ▲ | 57 oz, 9.25" Footed Serving Bowl | 02 | 12 ea |
| 43842 ▲ | 14" x 10" Oblong Platter | 02, 03 | 12 ea |
| Narrow Rimmed Displayware | | | |
| ARR112 ▲ | 14.75" x 10.5" Oval Platter | 02 | 12 ea |
| ARR120 ▲ | 12" x 8.5" Oval Platter | 02, 25 | 12 ea |
| 43745 ▲ | 28 oz, 10" x 7.5" Baker/Server | 02, 25 | 12 ea |
| 43840 ▲ | 21" x 15" Catering Platter | 02, 03 | 6 ea |
| 43772 ▲ | 15.5" x 10.5" Oblong Platter | 02 | 12 ea |

NSF Listed products are designated with a ▲ and may be prefixed with an N

Salad Bowl

- Made of dependable, impact-resistant melamine
- Safe for temperatures up to 212°F
- NSF Listed; dishwasher safe



1000B

Scalloped DeliWare® & Inset

- Low profile reduces food waste without sacrificing presentation
- 5.5" Square Scalloped Dish is designed to use alone or as an inset in the 18" x 7" Scalloped Platter (7932)
- Use the combination of our inset and platter for displaying foods with toppings or sauces
- Durable melamine material
- NSF Listed; dishwasher safe



7930

7934

7932

Black(03)

| Prod No | Description | Color | Pack |
|---------------------------------------|----------------------------------|-------|-------|
| Melamine Salad Bowls | | | |
| 1000B Δ | 1.9 qt, 10" Bowl | 03 | 6 ea |
| Scalloped DeliWare & Inset | | | |
| 7930 Δ | 14" x 10" Scalloped Baker | 03 | 4 ea |
| 7932 Δ | 18" x 7" Scalloped Platter | 03 | 4 ea |
| 7934 Δ | 5.5" Square Scalloped Dish/Inset | 03* | 48 ea |

NSF Listed products are designated with a Δ and may be prefixed with an N

* Color available by special order only

DISPLAYWARE

The look of Acacia Wood **without the hassle**. The Epicure Acacia Wood Grain line features an **assortment of sizes and shapes** and offers something for every type of food and venue.

Epicure® Acacia Wood Grain

- Durable Material is made of sturdy, break resistant melamine
- Look of organic acacia wood without the inconvenient need to handwash or season
- Buyer's assurance with a limited warranty against breakage
- Large selection with a size to fit every serving need from Dip Bowls to 18" Round platters
- Safe for temperatures up to 212°F
- Dishwasher safe and stain resistant
- NSF Listed



EAG09 Flight Tray & EAG08 Dip Bowls



| Prod No | Description | Color | Pack |
|--|---------------------------------|-------|-------|
| Epicure Acacia Wood Grain Displayware | | | |
| EAG01 ▲ | 7.5", 34 oz Small Bowl | 69 | 12 ea |
| EAG02 ▲ | 12", 4.8 qt Serving Bowl | 69 | 6 ea |
| EAG04 ▲ | 18" x 15" Oval Platter | 69 | 6 ea |
| EAG05 ▲ | 13.88" x 7.75" Rectangular Tray | 69 | 12 ea |
| EAG06 ▲ | 18" Round Platter | 69 | 6 ea |
| EAG07 ▲ | 14.75" x 6.75" Rectangular Tray | 69 | 12 ea |
| EAG08 ▲ | 4.38", 5 oz Dip Bowl | 69 | 12 ea |
| EAG09 ▲ | 13.19" Flight Tray | 69 | 6 ea |
| EAG10 ▲ | 19.25" Round Platter | 69 | 2 ea |
| EAG11 ▲ | 9" Square Tray | 69 | 12 ea |

NSF Listed products are designated with a ▲ and may be prefixed with an N

Designer Displayware®

- Heavy, china/ceramic feel and look without the breakage
- Perfect for salads and entrées in family style dining, banquets, buffets or deli display cases
- Select pieces available in unique two-tone Mosaic colors
- FDA approved material
- Safe for temperatures up to 212°F
- NSF Listed; dishwasher safe



| Prod No | Description | Color | Pack |
|------------------------------------|--|--------|------|
| Designer Displayware | | | |
| 7910 Δ | 5 lb, 10.5" Designer Pasta Bowl | 02, 03 | 4 ea |
| 7913 Δ | 10 lb, 13" Designer Pasta Bowl | 02, 03 | 4 ea |
| 7914 Δ | 2 qt, 14" x 10" Oval Designer Platter | 02, 03 | 4 ea |
| 7916 Δ | 3 qt, 16" x 12" Oval Designer Platter | 02, 03 | 4 ea |
| 7918 Δ | 4 qt, 19" x 13.75" Oval Designer Platter | 02, 03 | 4 ea |
| 7919 Δ | 2.9 qt, 9" x 12" Designer Baker | 02, 03 | 4 ea |
| 7920 Δ | 4 qt, 10" x 14" Designer Baker | 02, 03 | 4 ea |
| Mosaic Designer Displayware | | | |
| 8919 Δ | 2.9 qt, 9" x 12" Mosaic Baker | 406* | 4 ea |
| 8920 Δ | 4 qt, 10" x 14" Mosaic Baker | 406 | 4 ea |

NSF Listed products are designated with a Δ and may be prefixed with an N

* Color available by special order only

DISPLAYWARE

Tulip Deli® Crocks

- Beautiful swirl pattern and high gloss finish
- Crocks nest for easy storage
- Durable SAN plastic is resistant to food oils and acids
- Safe for use in temperatures from 0° to 180°F
- Dishwasher safe



Scoop Bowl

- 4 qt bowls are perfect for buffets or salad bar
- Durable SAN plastic is resistant to food oils and acids
- For use in temperatures from 0° to 180°F
- Dishwasher safe



| Prod No | Description | Color | Pack |
|--------------------------|---------------------------------------|------------|------|
| Tulip Deli Crocks | | | |
| 6963 ♦ | 5 lb, 10.38" x 6.75" Tulip Deli Crock | 02, 03, 05 | 6 ea |
| 6966 ♦ | 10 lb, 13" x 10.38" Tulip Deli Crock | 02, 03, 05 | 6 ea |
| Scoop Bowl | | | |
| 0411 | 4 qt, 13.75" x 9.38" Scoop Bowl | 02, 03 | 4 ea |

NSF Listed products are designated with a **▲** and may be prefixed with an N
 ♦ California Residents: Bisphenol A **WARNING:** See appendix A on page 1

Orchid® Deli Bowls

- Polycarbonate bowls and crocks have a beautiful, glass-like appearance without the breakage
- Extremely break-resistant material can be used in heated cases or on hot tiles up to 212°F
- Withstands exposure to food acids
- NSF Listed; dishwasher safe



Black(03)

| Prod No | Description | Color | Pack |
|--------------------------|-----------------------------|-------|-------|
| Orchid Deli Bowls | | | |
| 6531 Δ ♦ | 1.5 qt, 8" Orchid Deli Bowl | 03 | 12 ea |
| 6532 Δ ♦ | 3 qt, 10" Orchid Deli Bowl | 03 | 12 ea |
| 6534 Δ ♦ | 7 qt, 12" Orchid Deli Bowl | 03 | 12 ea |

NSF Listed products are designated with a Δ and may be prefixed with an N
 ♦ California Residents: Bisphenol A **WARNING:** See appendix A on page 1

DISPLAYWARE

Octagon Bowls

- Contemporary octagonal shape is ideal for table service, buffets, salad bars or deli displays
- Made of glossy acrylic
- 8888 offers the increased durability of SAN and is safe for use in temperatures from 32° to 160°F
- Dishwasher safe



Octagonal Cocks

- Crock inserts eliminate waste while giving a full appearance
- 2.5 lb low profile crock (6723) can be used as an insert for the 5 lb crock
- 5 lb low profile crock (6726) can be used as an insert for the 10 lb crock
- Durable SAN plastic is resistant to food oils and acids
- Safe for use in temperatures from 0° to 180°F
- Dishwasher safe



| Prod No | Description | Color | Pack |
|------------------------|---|--------|------|
| Octagon Bowls | | | |
| 8886 | 2.5 lb, 7.13" x 2.87" Octagon Bowl | 03 | 4 ea |
| 8887 | 5 lb, 9.19" x 3.04" Octagon Bowl | 03 | 4 ea |
| 8888 | 8 lb, 9.38" x 4.1" Deep Octagon Bowl | 03 | 4 ea |
| Octagonal Cocks | | | |
| 6713 | 5 lb, 10.63" x 7.19" Octagonal Crock | 03 | 6 ea |
| 6723 | 2.5 lb Low Profile Octagonal Crock (and Insert for 5 lb Crock 6713) | 02, 03 | 6 ea |
| 6716 | 10 lb, 13.31" x 10.5" Octagonal Crock | 03 | 6 ea |
| 6726 | 5 lb Low Profile Octagonal Crock (and Insert for 10 lb Crock 6716) | 03 | 6 ea |

Make waves with our modular displayware! This modular display system gives you so many options in setting up your display and it all looks perfectly organized when you are done.

Modular Displayware

- Wave shape offers visual interest while enhancing the display
- Unique, flexible displayware provides an attractive solution for merchandising prepared food
- Fits in standard size food wells
- Half long lid can be used as a display tray for sliced deli meats and cheeses
- Made of tough, break-resistant polycarbonate
- Safe for use in temperatures ranging from -40° to 212°F
- NSF Listed; dishwasher safe



Collar provides support for smaller pans when used in a food well



| Prod No | Description | Color | Pack |
|--------------------------------|---------------------------------------|---------|------|
| Modular Displayware | | | |
| 6982 Δ \blacklozenge | 4.45 qt Half Long Pan - Wavy Edge | 03, 07* | 6 ea |
| 6990 Δ \blacklozenge | 4.45 qt Half Long Pan - Straight Edge | 03 | 6 ea |
| 6982L Δ \blacklozenge | Half Long Lid | 07 | 6 ea |
| 6988 Δ \blacklozenge | Half Long Collar | 03 | 6 ea |
| 6984 Δ \blacklozenge | 6.5 cup, 2.5" Deep Half Size Pan | 03 | 6 ea |
| 69844 Δ \blacklozenge | 9.25 cup, 4" Deep Half Size Pan | 03 | 6 ea |
| 69846 Δ \blacklozenge | 13 cup, 6" Deep Half Size Pan | 03 | 6 ea |
| 6984L Δ \blacklozenge | Half Size Lid | 07 | 6 ea |
| 6986 Δ \blacklozenge | 4 cup, 2.5" Deep Third Size Pan | 03 | 6 ea |
| 69864 Δ \blacklozenge | 5.6 cup, 4" Deep Third Size Pan | 03 | 6 ea |
| 69866 Δ \blacklozenge | 7.8 cup, 6" Deep Third Size Pan | 03 | 6 ea |

NSF Listed products are designated with a Δ and may be prefixed with an N

* Color available by special order only

\blacklozenge California Residents: Bisphenol A **WARNING:** See appendix A on page 1

DISPLAYWARE

Rectangular Deli Crock

- Rectangular deli crock saves space in display cases
- Acrylic crock has a high gloss finish
- Safe for use in temperatures from 32° to 160°F
- Dishwasher safe



8821

Deliware® Rectangular Crocks

- Economical durable polypropylene for maximum impact resistance in cold temperatures
- Safe for use in temperatures from 32° to 170°F



8112

8110



| Prod No | Description | Color | Pack |
|------------------------------------|---|--------|-------|
| Rectangular Deli Crock | | | |
| 8821 | 10 lb, 12" x 10" Rectangular Crock | 03* | 4 ea |
| Deliware Rectangular Crocks | | | |
| 8110 | 5 lb, 10" x 6" Rectangular Crock | 02, 03 | 12 ea |
| 8112 | 10 lb, 12.5" x 10.25" Rectangular Crock | 02, 03 | 6 ea |

* Color available by special order only

Petal Mist® Plates, Bowls & Trays

- Petal Mist's delicate design gives an elegant appearance; perfect for buffets, food bars, delis, poolside and catering
- Textured exterior hides scratches; easy-clean smooth interior
- Made of tough, break-resistant polycarbonate
- Safe for use in freezers and in temperatures from 40° to 212°F
- Coordinates with Petal Mist Dinnerware—See page 29
- NSF Listed; dishwasher safe



| Prod No | Description | Color | Pack |
|--|--|--------|-------|
| Petal Mist Plates, Bowls & Tray | | | |
| 6908 ▲◆ | 1.2 qt, 7.5" Petal Mist Bowl | 03, 07 | 36 ea |
| 6909 ▲◆ | 2.4 qt, 9" Petal Mist Bowl | 03, 07 | 12 ea |
| 6931 ▲◆ | 3.4 qt, 9.75" Petal Mist Bell Bowl fits 8.25" template opening | 03, 07 | 4 ea |
| 6914 ▲◆ | 5.6 qt, 12" Petal Mist Bowl | 03, 07 | 4 ea |
| 6917 ▲◆ | 9.7 qt, 15" Petal Mist Bowl | 03, 07 | 4 ea |
| 6919 ▲◆ | 17.2 qt, 18" Petal Mist Bowl | 03, 07 | 4 ea |
| 6942 ▲◆ | 13" Petal Mist Plate | 07 | 6 ea |
| 6947 ▲◆ | 16" x 22" Petal Mist Rectangular Tray | 07 | 6 ea |

NSF Listed products are designated with a ▲ and may be prefixed with an N
 ◆ California Residents: Bisphenol A **WARNING:** See appendix A on page 1



DISPLAYWARE

Bell Bowls

- Pebbled design made of crystal-clear acrylic
- Dishwasher safe



Stack Bowls

- Use for food bars, buffets or table service
- 15" deep rim gives a stylish bowl appearance when placed into ice or refrigerated food bar templates
- Acrylic is resistant to food acids and oils
- Dishwasher safe



Leaf Bowls

- Perfect for salad bar or table service
- Acrylic is resistant to food acids and oils
- For use in temperatures from 32° to 160°F
- Dishwasher safe



Buffet Clam Shells

- Perfect for presenting seafood, salads and appetizers in a buffet or salad bar
- Durable SAN plastic is resistant to food oils and acids
- Safe for use in temperatures from 0° to 180°F
- Dishwasher safe



| Prod No | Description | Color | Pack |
|---|--------------------------------------|------------|-------|
| Bell Bowls | | | |
| SB90 | 3.3 qt, 11" Acrylic Pebbled Bowl | 07 | 4 ea |
| SB94 | 6 qt, 14" Acrylic Pebbled Bowl | 07 | 4 ea |
| Stack Bowls | | | |
| 8038 | 1.5 qt, 8" x 3.5" Stack Bowl | 03 | 4 ea |
| 8099 | 2.5 qt, 9" x 3.5" Stack Bowl | 03 | 4 ea |
| 8100 | 3 qt, 9.5" x 4" Stack Bowl | 03 | 4 ea |
| Leaf Bowls | | | |
| LB12 | 3 qt, 11.25" Leaf Bowl | 07 | 4 ea |
| LB16 | 8 qt, 15.38" Leaf Bowl | 07 | 4 ea |
| Buffet Clam Shells | | | |
| 339 | 12 oz, 8.88" x 5.5" Small Clam Shell | 02, 07 | 12 ea |
| 0340 | 22 oz, 11" x 7" Medium Clam Shell | 02, 03, 07 | 12 ea |
| 0344 ▲ | 5 qt, 19" x 12.88" Large Clam Shell | 02, 03, 07 | 1 ea |

NSF Listed products are designated with a ▲ and may be prefixed with an N

Round Polycarbonate Pebbled Bowls

- Pebbled exterior resists scratches
- Smooth interior is unaffected by salad oils, food acids or dressings
- Durable polycarbonate is safe for use in temperatures from 40° to 212°F
- NSF Listed; dishwasher safe



Acrylic Pebbled Bowls

- Acrylic bowls have heat polished, high-gloss rim
- Pebbled finish resists scratches
- Dishwasher safe



| Prod No | Description | Color | Pack |
|--|--|--------|-------|
| Round Polycarbonate Pebbled Bowls | | | |
| 7206 Δ \blacklozenge | 0.6 qt, 6" Round PC Bowl | 07 | 12 ea |
| 7208 Δ \blacklozenge | 1.62 qt, 8" Round PC Bowl | 07 | 12 ea |
| 7210 Δ \blacklozenge | 3 qt, 10" Round PC Bowl | 07 | 12 ea |
| 7212 Δ \blacklozenge | 5.5 qt, 12" Round PC Bowl | 07 | 12 ea |
| 7215 Δ \blacklozenge | 11 qt, 15" Round PC Bowl | 07 | 4 ea |
| 7218 Δ \blacklozenge | 18 qt, 18" Round PC Bowl | 07 | 4 ea |
| 7223 Δ \blacklozenge | 33 qt, 23" Round PC Bowl | 07 | 4 ea |
| Round Acrylic Pebbled Bowls | | | |
| SB66 | .5 qt, 6" Acrylic Round Bowl | 07 | 8 ea |
| SB68 | 1 qt, 8" Acrylic Round Bowl | 07 | 4 ea |
| SB70 | 2 qt, 10" Acrylic Round Bowl | 07 | 4 ea |
| SB72 | 4 qt, 12" Acrylic Round Bowl | 07 | 4 ea |
| SB74 | 7 qt, 14" Acrylic Round Bowl | 07 | 4 ea |
| SB76 | 10 qt, 16" Acrylic Round Bowl | 07 | 4 ea |
| SB78 | 15 qt, 18" Acrylic Round Bowl | 07 | 4 ea |
| SB79 | 24 qt, 22" Acrylic Round Bowl | 07 | 4 ea |
| Oval Acrylic Pebbled Bowls | | | |
| OSB172 | 5.5 qt, 10.5" x 14" Acrylic Oval Bowl | 07 | 4 ea |
| OSB176 | 11 qt, 13" x 18" Acrylic Oval Bowl | 03, 07 | 4 ea |
| OSB178 | 15 qt, 15.25" x 21.88" Acrylic Oval Bowl | 03, 07 | 4 ea |

NSF Listed products are designated with a Δ and may be prefixed with an N
Shipping Notes: 7223 and SB79 can ship UPS/FedEx Ground at oversize cost

\blacklozenge California Residents: Bisphenol A **WARNING:** See appendix A on page 1

DISPLAYWARE

Double-Wall Stainless Steel Displayware

- Beautiful, heavy-duty, stainless steel displayware designed for delis, buffets and special event service
- The modern hammered finish hides scratches for a longer life
- Double wall construction provides insulation to help with temperature retention with both hot and cold foods; no need to preheat or chill
- Double wall construction with air insulation prevents sweating for a fresher looking display
- 609201, 609202, 609203 and 609204 bowls have dual-base indentions allowing bowls to sit flat or at an angle for a more dramatic display and easy food access
- Keeps food under 41°F for up to 2 hours or more



Double Wall Construction/Air Insulation:

- Helps with temperature retention for both hot and cold foods
- Keeps food under 41°F for up to 2 hours or more

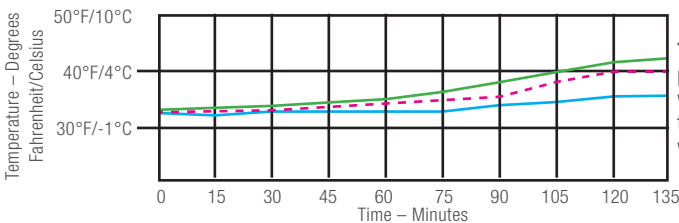

- 609211 3.5 qt, 10" Square Bowl
- 609209 4.38 qt, 10-3/4" Serving Bowl
- 609204 9.5 qt, 14" Dual Angle Bowl

Testing Conditions: Chilled cottage cheese was placed in a room temperature bowl. The bowls were left undisturbed in a 72° to 78°F room until temperatures rose above 40°F. Temperature in center was measured and recorded in 5 minute increments.

| Prod No | Description | Pack |
|--|---|------|
| Double-Wall Stainless Steel Displayware | | |
| 609201 | 1.7 qt, 8" Dual Angle Bowl with Hammered Finish | 2 ea |
| 609202 | 3.38 qt, 10" Dual Angle Bowl with Hammered Finish | 2 ea |
| 609203 | 5.75 qt, 12" Dual Angle Bowl with Hammered Finish | 2 ea |
| 609204 | 9.5 qt, 14" Dual Angle Bowl with Hammered Finish | 2 ea |
| 609209 | 4.38 qt, 10.75" Serving Bowl with Hammered Finish | 2 ea |
| 609211 | 3.5 qt, 10" Square Bowl with Hammered Finish | 2 ea |
| 609216 | 15" x 8.5" Curved Tray with Hammered Finish | 2 ea |

Display Covers (Cover Only)

- Covers enhance and protect the look of your food items; helps keep food fresh
- Use for merchandising fresh fruits, desserts, salads, sandwiches or bakery items
- Polycarbonate dome covers add increased durability and can be used in more extreme foodservice applications



PSD21EH

Use Display Covers with our full- and half-size food pans shown on pages 224-225

Cake Covers & Tray

- Clear covers display desserts and pastries
- Sanitary covers help keep foods fresher longer
- Dishwasher safe



3004

2512

SC32

Step Risers

- Step Risers create height in your food presentation
- Offers better visibility and helps merchandise foods

Polycarbonate Step Risers

- 6843 polycarbonate riser is virtually unbreakable; won't dent or chip

ABS Step Risers

- Edges have air slots for increased air circulation
- ABS plastic is very durable and easy to clean; will not warp or chip
- Textured satin finish decreases glare, hides scratches



6863

6843



| Prod No | Description | Pack |
|--|--|-------|
| Display Covers (Trays Not Included) | | |
| PSD13EH ♦ | 12" x 10" End Cut Display Cover | 1 ea |
| PSD13CH ♦ | 12" x 10" Center Cut Display Cover | 1 ea |
| PSD21EH ♦ | 12" x 20" End Cut Display Cover | 1 ea |
| PSD21CH ♦ | 12" x 20" Center Cut Display Cover (7.88" x 6.75" opening) | 1 ea |
| PSD21DEH ♦ | 12" x 20" Double End Cut Display Cover | 1 ea |
| Cake Covers & Tray | | |
| SC32 | 12" x 6" Cake Cover, Acrylic | 6 ea |
| 2512 | 12" x 6.5" Cake Cover, SAN | 6 ea |
| 3004 | 14" Display Tray, SAN | 12 ea |
| Step Risers | | |
| 6843 ▲ ♦ | 11.75" 3-Step Polycarbonate Riser** | 1 ea |
| 6863 | 23.5" 3-Step Riser ABS Riser | 1 ea |

NSF Listed products are designated with a ▲ and may be prefixed with an N

**Item available by special order only

♦ California Residents: Bisphenol A **WARNING:** See appendix A on page 1



SERVINGWARE

The rustic charm of this **hammered steel inspired** serveware adds an **upscale flare to foodservice displays** with the unbeatable **durability of stainless steel.**

Terra™ Stainless Steel Serveware

- Contemporary finish of hammered steel styling creates a rustic, urban-luxury aesthetic
- Versatile and subtle styling complements existing serveware ideal for restaurants, delis and buffets
- Durable metal is forged from 18/0, 430 grade stainless steel for a superior lifespan
- Weight balanced design allows for easy holding/gripping
- Dishwasher safe
- Towel dry recommended



| Prod No | Description | Pack |
|--|---------------------------|-------|
| Terra Stainless Steel Serveware | | |
| 60200 | 12" Solid Serving Spoon | 12 ea |
| 60201 | 12" Slotted Serving Spoon | 12 ea |
| 60202 | 12" Cold Meat Fork | 12 ea |
| 60203 | 13.5" Ladle | 12 ea |
| 60204 | 12" Pie Server | 12 ea |
| 60205 | 10" Solid Spoon | 12 ea |
| 60206 | 9.5" Solid Spoon | 12 ea |
| 60207 | 11" Cake Server | 12 ea |
| 60208 | 8.75" Ladle | 12 ea |
| 60209 | 7" Tong | 12 ea |
| 60210 | 10" Tong | 12 ea |
| 60211 | 12" Tong | 12 ea |

Aria™

- Beautiful gleaming 18-8 mirror polished stainless steel
- Heavy-duty and more economical than comparable hollow handle items
- Ladles have one ounce oval shaped bowl for pouring dressings from either side
- Dishwasher safe



| Prod No | Description | Pack |
|-------------|-------------------------------|-------|
| Aria | | |
| 609001 | 12" Aria Solid Spoon | 12 ea |
| 609002 | 12" Aria Slotted Spoon | 12 ea |
| 609005 | 10.75" Aria Cold Meat Fork | 12 ea |
| 609006 | 11.75" Aria Wide Pie Server | 12 ea |
| 609007 | 11" Aria Narrow Pastry Server | 12 ea |
| 609009 | 10" Aria Solid Spoon | 12 ea |
| 600295 | 9.5" Aria Ladle | 12 ea |
| 600296 | 13.5" Aria Ladle | 12 ea |
| 604460 | 9.25" Aria Solid Spoon | 12 ea |
| 604606 | 6" Aria Salad Tong | 12 ea |
| 604609 | 9" Aria Salad Tong | 12 ea |



SERVINGWARE

Buffet Tongs

- Heavy-duty 18-8 stainless steel with mirror polished finish for long lasting use
- Durable sanitary one-piece construction
- Scissor tongs are two-piece satin finish construction
- Dishwasher safe



| Prod No | Description | Pack |
|---------------------|----------------------------------|-------|
| Buffet Tongs | | |
| 607680 | 8" Pastry Tong | 12 ea |
| 607682 | 8" Serving Tong | 12 ea |
| 607683 | 10.25" Scalloped Serving Tong | 12 ea |
| 607685 | 10" Scissors Salad Tong | 12 ea |
| 607687 | 9.25" Bread Serving Tong | 12 ea |
| 607690 | 5.75" Ice Tong | 12 ea |
| 607691 | 7" Ice Tong | 12 ea |
| 607692 | 10" Scalloped Bread Serving Tong | 12 ea |
| 607693 | 9" Salad Tong | 12 ea |
| 607695 | 9.5" Pastry Tong | 12 ea |
| 607697 | 11.75" Serving Tong | 12 ea |

ICE SCULPTURES

Ice Sculptures

- Quick and easy way to turn any table into a showpiece
- Fill mold with water, freeze (48-72 hours) and cut open the mold
- Features patented EZ-Cut Bead™ and Contracting Cone Base™
- One time use
- Instructions included with every Ice Sculpture



SCL1

SSW1



SD01

SBG1

Contracting Cone Base allows for expansion while freezing to eliminate the major cause of cracking and breaking in the freezing process.

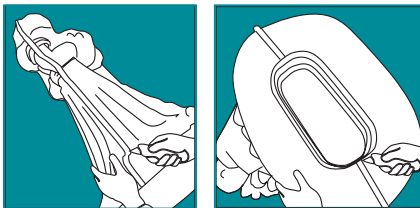

SEA1

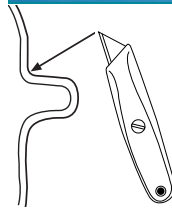

Exclusive EZ-Cut Bead opening system makes it quick and easy to un-mold a work of art.



SD01

Illuminated Trays

- Perfect for use at buffets or banquets or as an accent for ice sculptures
- Light boxes come with Blue, Red and Yellow colored panels
- Light box is UL listed, fuse protected and operates on 115 volt/60 cycle AC
- Drain kits included

| | |
|-----------|----------------|
| White(02) | Designated(00) |
|-----------|----------------|

| Prod No | Description | Color | Pack |
|--------------------------|--|-------|------|
| Ice Sculptures | | | |
| SSW1 | Swan: 19" L x 12" W x 21.5" H | 02 | 1 ea |
| SD01 | Dolphin: 20.5" L x 14.25" W x 25" H | 02 | 1 ea |
| SBG1 | Bride and Groom: 22" L x 14" W x 28" H | 02 | 1 ea |
| SCL1 | Clam Shell: 18" L x 12" W x 19" H | 02 | 1 ea |
| SEA1 | Eagle: 15.5" L x 24" W x 29" H | 02 | 1 ea |
| Illuminated Trays | | | |
| SL6011L | Large Light Box (no tray) | 00 | |
| SL6011TC* | Large Smooth Light Box Tray (only) | 00 | 1 ea |

* Drain Kits are included with Light Box Tray

NOTE: Light Boxes & Trays are sold separately; SD01, SBG1, SCL1 and SEA1, can be shipped UPS/FedEx Ground at oversize cost

BUFFET ACCESSORIES

NeWave™ Drip Trays

- Patented NeWave Drip Trays with open, free-flowing design dissipates fluid spills evenly to allow quicker evaporation
- NeWave pattern keeps mug, cup and pitcher bases dryer by eliminating the common fluid traps on other designs
- Easy to empty and clean
- NSF Listed; dishwasher safe

Octagonal Drip Tray U.S. Patent No. D-418,376;
 Rectangular Drip Tray U.S. Patent No. D-418,377

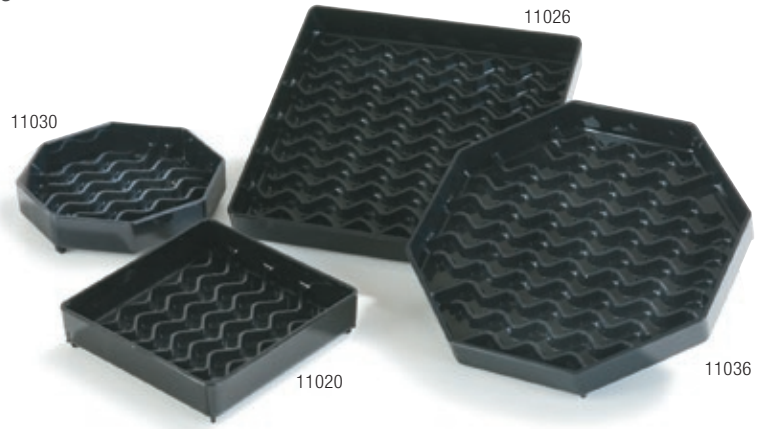

Punch/Serving Bowls

- Mirror-polished finish exterior and rim, satin finish interior
- Heavy gauge 18-8 stainless steel with argon welded bases for exceptional strength
- Handwashing recommended



Black(03)

| Prod No | Description | Color | Pack |
|----------------------------|---------------------------------|-------|-------|
| NeWave Drip Trays | | | |
| 11020 Δ | NeWave 4" Square Drip Tray | 03 | 12 ea |
| 11030 Δ | NeWave 4" Octagon Drip Tray | 03 | 12 ea |
| 11026 Δ | NeWave 6" Square Drip Tray | 03 | 12 ea |
| 11036 Δ | NeWave 6" Octagon Drip Tray | 03 | 12 ea |
| Punch/Serving Bowls | | | |
| 609310 | 10 qt, 15.5" Punch/Serving Bowl | — | 1 ea |
| 609316 | 16 qt, 18" Punch/Serving Bowl | — | 1 ea |

NSF Listed products are designated with a Δ and may be prefixed with an N

MirAcryl™ Cubes

- Design allows smaller size cubes to nest inside larger cubes for convenient storage
- Invert to use as ice bucket or wine server
- Light-weight, break-resistant acrylic



MirAcryl Mirrored Display Trays

- Beautiful, durable display pieces are easy to clean
- Made of light-weight acrylic
- Two-sided surface – use Mirrored or solid Black side for display

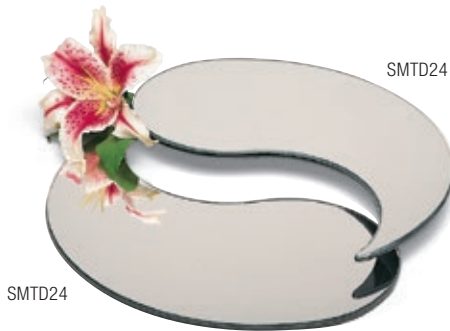

Mirror Acrylic(23)

| Prod No | Description | Color | Pack |
|--|-----------------------------------|-------|------|
| MirAcryl Cubes | | | |
| SMMC10 | 10" Mirror Cube | 23 | 1 ea |
| SMMC12 | 12" Mirror Cube | 23 | 1 ea |
| MirAcryl Mirrored Display Trays | | | |
| SMO1624 | 24" x 16" Oval MirAcryl Tray | 23 | 1 ea |
| SMR1624 | 24" x 16" Rectangle MirAcryl Tray | 23 | 1 ea |
| SMR1836 | 36" x 18" Rectangle MirAcryl Tray | 23 | 1 ea |
| SMR24 | 24" Round MirAcryl Tray | 23 | 1 ea |
| SMTD24 | 24" Teardrop MirAcryl Tray | 23 | 1 ea |

NOTE: MirAcryl™ is not returnable if the protective film is removed



CARLISLE
FOODSERVICE PRODUCTS



INNOVATIVE GUEST- PLEASING VERSATILE DEPENDABLE **FOOD BARS & CONVENIENCE PRODUCTS**

Carlisle's workhorse portable food bars, innovative Coldmaster line and industry-leading lineup of serving and convenience smallwares are critical dining supplies for your operation.

Count on Carlisle to offer products that are attractive, durable and designed to improve your operational efficiency.





COLDMASTER®

The Coldmaster solution **eliminates** the **inconvenience** and mess of ice, as well as reduces the potential for bacteria. The Coldmaster solution is **revolutionizing** the food pan category, offering **innovative** solutions and **making work easier**.



Coldmaster® CoolCheck™

- Patent-pending technology allows you to quickly see when temperatures are no longer safe
- Same great features as our standard Coldmaster products with the added element of color-changing technology
- Eliminates the guessing game behind food safety
- Unit holds food safely below 41°F for 6-8 hours*
- Reduces waste by “telling” workers when food temperature is safe
- Eliminates the mess and inconvenience of ice
- FDA approved; dishwasher safe
- Use Coldmaster Lids listed on pages 111-112
- NSF Listed

*Time will vary based on ambient room temperature



Designed to fit in standard sized food pan templates or food wells



Food Safe Temp

Above Food Safe Temp

White(02)

| Prod No | Description | Color | Pack |
|-----------------------------|---|-------|------|
| Coldmaster CoolCheck | | | |
| CM1100C14 Δ | 6" Deep Full-size Food Pan | 02 | 1 ea |
| CM1101C14 Δ | 6" Deep Half-size Food Pan | 02 | 1 ea |
| CM1102C14 Δ | 6" Deep Third-size Food Pan | 02 | 1 ea |
| CM1103C14 Δ | 6" Deep Third-size Divided Food Pan | 02 | 1 ea |
| CM1104C14 Δ | 6" Deep Sixth-size Food Pan | 02 | 1 ea |
| CM1105C14 Δ | 6" Deep High Capacity Sixth-size Food Pan | 02 | 1 ea |

NSF Listed products are designated with a **Δ** and may be prefixed with an N



The Coldmaster Solution:



- High-impact ABS plastic holds up to foodservice use
- Exclusive refrigerant gel ensures high performance
Non-toxic gel receives a cold "charge" when frozen overnight, which enables it to keep your food cold throughout the day
- Extra insulation surrounds refrigerant gel for maximum cold retention
- Refrigerant gel is enclosed in a bag; prevents leaks, even if shell is damaged

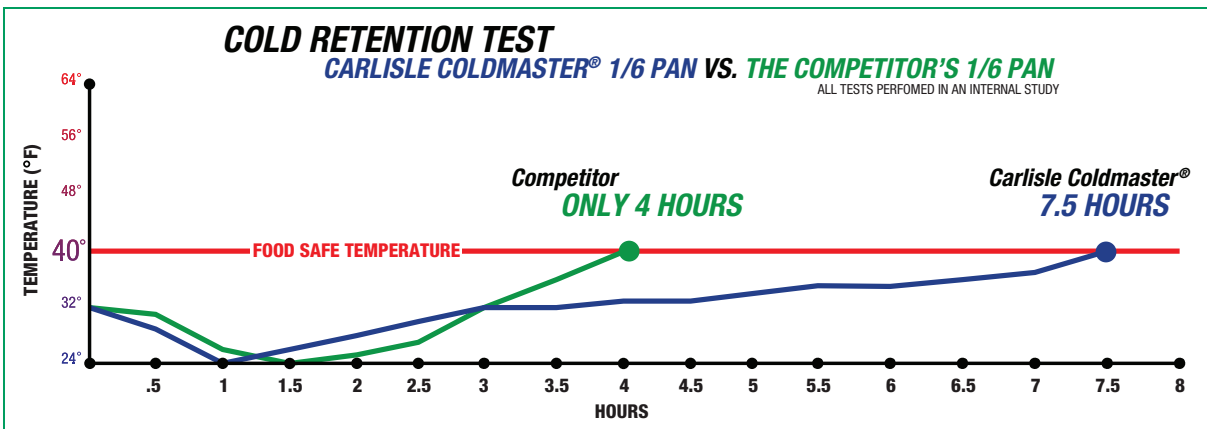

Coldmaster line includes a full suite of **COLD RETENTION SOLUTIONS** such as 3 gallon ice-cream servers, condiment bars and industry firsts such as CoolCheck™ and Designer pans

- Exclusive refrigerant gel ensures **HIGH PERFORMANCE**
- NON-TOXIC** gel receives a cold "charge" when frozen overnight, which enables it to keep your food cold throughout the day
- Extra insulation surrounds refrigerant gel for **MAXIMUM COLD RETENTION**
- Refrigerant gel is enclosed in a bag; **PREVENTS LEAKS**, even if shell is damaged, ensures 100% coverage and helps keep it in place

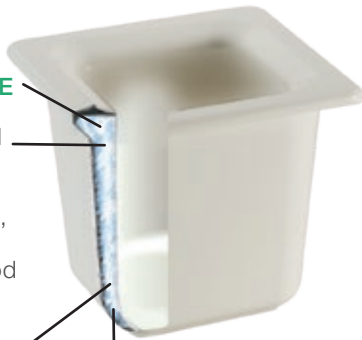

VS.

Competitor



- Gel is not enclosed in a bag, less protection if there is a break
- Units must be stored upside down or food in the unit is not chilled at the top of the pan
- No additional insulation means that there is much less "chill time"
- Limited Assortment



COLDMASTER®

Coldmaster = Peace of Mind

Coldmaster products are available in a variety of shapes and sizes from food pans to crocks, to ice cream servers. Coldmaster offers peace of mind while it keeps your food cold and fresh. Enjoy the convenience of Coldmaster, as it allows you to transport and keep food cold, anywhere you need to without messy ice or electricity.

Coldmaster Products Exceed Health Department Requirements

- With one overnight charge in your freezer, each Coldmaster keeps food at or below the ServSafe®* guidelines of 40°F for up to eight hours**

Coldmaster Products Meet FDA Standards

- All Coldmaster products are filled with an exclusive non-toxic refrigerant gel
- Constructed of high-impact ABS plastic
- Dishwasher safe



Coldmaster® Whipped Cream & 1 Quart Carton Chillers

- Chillers use the same technology as standard Coldmaster pans
- CM1107 is designed to hold a standard 1qt carton; keeps dairy/egg cartons cold up to 8 hours**
- CM1108 is designed to hold a whipped cream can and provide food-safe chilling for up to 8 hours**
- NSF Listed



| Prod No | Description | Color | Pack |
|----------------------------|---------------------------|--------|------|
| Coldmaster Chillers | | | |
| CM1107 Δ | 1 Quart Carton Chiller | 02, 03 | 1 ea |
| CM1108 Δ | Whipped Cream Can Chiller | 02, 03 | 1 ea |

NSF Listed products are designated with a **Δ** and may be prefixed with an N

*ServSafe is a registered trademark of the National Restaurant Association

**Temperature retention is based on crocks being pre-frozen for a minimum of eight hours, then filled directly with pre-chilled foods. Testing was conducted under ambient room temperatures of 76°F.



Standard Food Pans & Lids

- Designed to fit in standard sized food pan templates
- Save time and labor by placing food directly into Coldmaster Standard Pans
- Third-size divided splits into two sixth-size food pans
- NSF Listed



Coldmaster Lids

- Designed to fit Coldmaster Standard Food Pans
- Clear acrylic lid protects against contaminants
- Helps maintain cold temperatures so your food stays fresh longer
- Molded-in handle allows easy removal



| Prod No | Description | Color | Pack |
|---|---|--------|------|
| Coldmaster Standard Food Pans & Lids | | | |
| CM1100 Δ | 6" Deep Full-size Food Pan | 02, 03 | 1 ea |
| CM1101 Δ | 6" Deep Half-size Food Pan | 02, 03 | 1 ea |
| CM1102 Δ | 6" Deep Third-size Food Pan | 02, 03 | 1 ea |
| CM1103 Δ | 6" Deep Third-size Divided Food Pan | 02, 03 | 1 ea |
| CM1104 Δ | 6" Deep Sixth-size Food Pan | 02, 03 | 1 ea |
| CM1105 Δ | 6" Deep High Capacity Sixth-size Food Pan | 02, 03 | 1 ea |
| CM1125 | Full-size Coldmaster Lid | 07 | 2 ea |
| CM1126 | Half-size Coldmaster Lid | 07 | 2 ea |
| CM1127 | Third-size Coldmaster Lid | 07 | 2 ea |
| CM1128 | Sixth-size Coldmaster Lid | 07 | 2 ea |

NSF Listed products are designated with a Δ and may be prefixed with an N



COLDMASTER®

Carlisle's EZ Access Lids were designed in **collaboration** with the people who **use our products everyday.**

Coldmaster EZ Access Lids

- Lids fit standard Coldmaster Food Pans shown on page 111
- Snug fit ensures they won't pop off, even when leveling a measure miser on the sidewall
- Innovative design includes lipped notches that allow the lid to be opened with a simple flick of the wrist or serving utensil
- Raised design allows maximum fill of your food pan
- Easy-clean design eliminates food traps and allows for easy cleanability
- Convenient hang hole for easy storage when not in use
- NSF Listed

Pan/Organizer with PC Food Pans and EZ Access Lids



CM1049



CM103190Z

CM10280Z



CM10240Z

Clear(07)

| Prod No | Description | Color | Pack |
|----------------------------------|-----------------------------|-------|------|
| Coldmaster EZ Access Lids | | | |
| CM10238Z ▲◆ | 1/2 Size Lid | 07 | 2 ea |
| CM10239Z ▲◆ | 1/2 Size Lid with Notch | 07 | 2 ea |
| CM10240Z ▲◆ | 1/2 Size Lid with 2 Notches | 07 | 2 ea |
| CM10278Z ▲◆ | 1/3 Size Lid | 07 | 2 ea |
| CM10279Z ▲◆ | 1/3 Size Lid with Notch | 07 | 2 ea |
| CM10280Z ▲◆ | 1/3 Size Lid with 2 Notches | 07 | 2 ea |
| CM10318Z ▲◆ | 1/6 Size Lid | 07 | 2 ea |
| CM10319Z ▲◆ | 1/6 Size Lid with Notch | 07 | 2 ea |

NSF Listed products are designated with a ▲ and may be prefixed with an N

◆ California Residents: Bisphenol A **WARNING:** See appendix A on page 1



The **safest and most convenient** way to keep foods held in metal pans cold for **up to 8 hours** during outdoor or off-site events. Coldmaster Coldpans allow your operation to keep **limited-time-offer items** chilled **without having to expand your cold well.**

Pan/Organizer with standard Food Pans



Coldmaster Coldpans

- Designed with the same capacity as traditional style food pans; will hold DuraPan™ Food Pans (pages 224-225)
- Holds and keeps standard food pans cold
- CM1049 Pan Organizer is a 6" deep full size coldpan designed to hold (9) ninth-size food pans for easy organization
- NSF Listed, dishwasher safe



| Prod No | Description | Color | Pack |
|---------------------------------|--|--------|------|
| Coldmaster Coldpans | | | |
| CM1042 Δ | 6" Deep Full-size Coldpan (will hold full, third or half size pans) | 02, 03 | 1 ea |
| CM1040 Δ | 4" Deep Full-size Coldpan (will hold full, third or half size pans) | 02 | 1 ea |
| CM1042LP | Full Size Coldpan Lid (fits CM1040, CM1042 and CM1049) | 02 | 1 ea |
| CM1043 Δ | 6" Deep Half-size Long Coldpan (will hold 1 half-long pan) | 02 | 1 ea |
| CM1045 Δ | 6" Deep Third-size Coldpan (will hold third, sixth or ninth size pans) | 02 | 1 ea |
| CM1046 Δ | 6" Deep Two-Thirds size Coldpan (will hold two-third or third size pans) | 02 | 1 ea |
| Coldmaster Pan/Organizer | | | |
| CM1049 | 6" Deep Full-size Coldpan with Organizer (does not include food pans) | 02 | 1 ea |

NSF Listed products are designated with a Δ and may be prefixed with an N



COLDMASTER®

The decorative styling of Designer Coldmaster allows **complete versatility**. Designer has all the features of our regular Coldmaster products, but with a **premium design** that looks good on a buffet, salad bar or any tabletop presentation.

Designer Coldmaster

- High-impact ABS material stands up to rigorous use
- Eliminates the labor needed to refill unsanitary ice baths and reduces food waste by keeping food chilled
- Holds food temperatures at or below the ServSafe®** temperature of 40°F for up to four hours†
- Keeps salads fresh and crisp for hours
- Provides a classy look for bar toppings
- Clear polycarbonate lids (sold separately) help preserve food freshness
- Crocks are NSF listed and dishwasher safe



CM140102



CM1408



CM1405

CM1400443

CM1401440

CM140003



CM1400442*

CM1402444

CM1400439*

CM140002

*Special order colors require a MOQ of 400 pieces and 3 weeks lead time for production.

**ServSafe® is a registered trademark of the National Restaurant Association

† Temperature retention is based on Coldmaster being pre-frozen for a minimum of eight hours, then filled directly with pre-chilled foods. Testing was conducted under ambient room temperatures of 76°F



Ice Cream Server & Lid

- Coldmaster technology and benefits (see pages 108-109)
- Accommodates standard 3-gallon ice cream tubs
- FREE, clear polycarbonate lid included with each Coldmaster Ice Cream Server
- Replacement Lids (CM1013) also available



CM1012

Ice Cream Shroud

- Attractive stainless steel cover offers an upscale appearance



CM1012 with 38655 Shroud

| | | | | |
|-----------------------|----------------------|-----------------------|--------------------|---------------------|
| White/White(02) | Black/Black(03) | Clear(07) Lids Only | White/Pewter(440) | Black/Charcoal(444) |
| White/Champagne(439)* | White/Charcoal(441)* | Black/Champagne(442)* | Black/Pewter(443)* | |

| Prod No | Description | Color | Pack |
|--|-------------------------------------|--------------------|------|
| Designer Coldmaster – Stocked | | | |
| CM1400 Δ | 1 qt Flared Square | 02, 03, 440, 444 | 1 ea |
| CM1401 Δ | 2 qt Flared Square | 02, 03, 440, 444 | 1 ea |
| CM1402 Δ | 5 qt Oval | 02, 03, 440, 444 | 1 ea |
| Designer Coldmaster – Special Order* | | | |
| CM1400 Δ | 1 qt Flared Square | 439, 441, 442, 443 | 1 ea |
| CM1401 Δ | 2 qt Flared Square | 439, 441, 442, 443 | 1 ea |
| CM1402 Δ | 5 qt Oval | 439, 441, 442, 443 | 1 ea |
| Designer Coldmaster Lids | | | |
| CM1403 \diamond | 1 qt Lid Solid (fits CM1400) | 07 | 1 ea |
| CM1404 \diamond | 1 qt Lid Notched (fits CM1400) | 07 | 1 ea |
| CM1405 \diamond | 2 qt Lid Solid (fits CM1401) | 07 | 1 ea |
| CM1406 \diamond | 2 qt Lid Notched (fits CM1401) | 07 | 1 ea |
| CM1407 \diamond | 5 qt Lid Solid (fits CM1402) | 07 | 1 ea |
| CM1408 \diamond | 5 qt Lid Notched (fits CM1402) | 07 | 1 ea |
| Coldmaster Ice Cream Server, Lid & Shroud | | | |
| CM1012 Δ | 3 gal Coldmaster Ice Cream Server | 02, 03 | 1 ea |
| CM1013 \diamond | Lid for Coldmaster Ice Cream Server | 07 | 1 ea |
| 38655 | Coldmaster Ice Cream Shroud | — | 1 ea |

NSF Listed Products are designated with a Δ and may be prefixed with an N

*Special order colors require a MOQ of 400 pieces and 3 weeks lead time for production.

\diamond California Residents: Bisphenol A **WARNING:** See appendix A on page 1



COLDMASTER®

Coldcrock

- Same Coldmaster technology and benefits (see pages 108-109)
- Crock holds 2 quarts of salad, dressing or condiments
- NSF Listed



Coldcrock Accessories

- Use Standard Pump (CM1035) with ketchup, mayonnaise, mustard or other sauces; can be used with or without insert to provide accurate .5 ounce or 1 ounce portions
- Fixed Nozzle Pump (38600R) dispenses 1 ounce per stroke; flow back design prevents messy dripping
- Maxi Pump (CM1037) dispenses 1 ounce portions of salsa, dressings and other chunky condiments
- Maxi Pump's long nozzle allows easier dispensing; comes with snap-in nozzle restrictors to help eliminate dripping when dispensing thinner condiments



| Prod No | Description | Color | Pack |
|---|--|------------|------|
| Coldmaster Coldcrock & Accessories | | | |
| CM1030 Δ | 2 qt Coldcrock (includes Coaster) | 02, 03, 23 | 1 ea |
| CM1032 | Clear Solid Lid | 07 | 2 ea |
| CM1033 | Clear Slotted Lid | 07 | 2 ea |
| CM1033P | Clear Pump Lid (use with pumps below) | 07 | 2 ea |
| CM1035 | .5 or 1 oz Standard Pump | 02 | 2 ea |
| CM1037 | 1 oz Maxi Pump includes 2 sizes Nozzle Restrictors | 02 | 2 ea |
| 38600R | 1 oz Fixed Nozzle Pump | — | 1 ea |

NSF Listed products are designated with a **Δ** and may be prefixed with an N



Condiment Bar Organizers

- Condiment organizer available for 3 or 6 qt Coldcrocks
- Organizer is made of sturdy, high-impact plastic
- Textured exterior hides scratches
- Order organizer separately or as a set with crocks, lid and pumps (CM1058)
- Coldcrocks (CM1030) sold separately; see facing page for details



CM1065 with Coldmaster Crocks

Dispenser

- Coldmaster technology & benefits
- Perfect for milk, cream and other temperature sensitive condiments
- Faucet style dispenser offers better control for dispensing liquids

Find replacement parts at www.carlislefp.com/replacement-parts

CM1017



| Prod No | Description | Color | Pack |
|--|---|-------|-------|
| Coldmaster Condiment Bar Organizers | | | |
| CM1058 | Crock & Organizer Condiment Set (3-Crock Coldcrock Organizer and 3 ea Coldmaster Crocks, Pump Lids and Condiment Pumps) | 02 | 1 set |
| CM1065 | 6-Crock Coldcrock Organizer (only) | 02 | 1 ea |
| CM1069 | 3-Crock Coldcrock Organizer (only) | 02 | 1 ea |
| Coldmaster Dispenser | | | |
| CM1017 | 5 qt Coldmaster Milk Dispenser & Lid | 03 | 1 ea |

NSF Listed products are designated with a **Δ** and may be prefixed with an N



CROCKS

Coordinate with colorful quality crocks from Carlisle. We've got the **durability, beauty and value** you are looking for in a variety our competitors can't beat. Each style has its own features and benefits so you can **select the crock that best suits your needs.**



Classic

- Thick-walled, heavy-weight design; made of SAN
- Chemical resistance to food acids and dressings
- High-gloss finish is extremely scuff-resistant
- 0°F to 180°F temperature range
- 0.6 quart crock fits inside 1.2 quart crock for smaller portions
- Translucent snap-on lids included
- NSF Listed; dishwasher safe

Poly-Tuf™

- Optimum wall design gives greater break-resistance
- Glossy-finish crocks resist chipping and cracking
- Withstands temperatures from 32°F to 180°F
- Translucent snap-on lids included
- NSF Listed; dishwasher safe



| Prod No | Description | Color | Pack |
|---|--|--------------------|-------|
| Classic Crocks | | | |
| 0300 ▲ | 0.6 qt Classic Crock with Lid | 03 | 12 ea |
| 0301 ▲ | 1.2 qt Classic Crock with Lid | 01, 02, 03, 06, 07 | 12 ea |
| 0316 ▲ | 1.5 qt Classic Crock with Lid | 01, 03, 06, 07 | 6 ea |
| 0302 ▲ | 2.7 qt Classic Crock with Lid | 01, 02, 03, 06, 07 | 6 ea |
| 0304 ▲ | 4.0 qt Classic Crock with Lid | 03 | 6 ea |
| Poly-Tuf Crocks | | | |
| 0341 ▲ | 1.2 qt Poly-Tuf Crock with Lid | 01, 03, 06 | 12 ea |
| 0343 ▲ | 1.5 qt Poly-Tuf Crock with Lid | 01, 03, 06 | 6 ea |
| 0342 ▲ | 2.7 qt Poly-Tuf Crock with Lid | 01, 03, 06 | 6 ea |
| Replacement Lids For Classic & Poly-Tuf Crocks | | | |
| 0311 ▲ | Lid - 0.6/1.2 qt (fits 0300, 0301, 0341) | 30 | 12 ea |
| 0202 ▲ | Lid - 1.5/2.7 qt (fits 0302, 0316, 0342, 0343) | 30 | 6 ea |
| 0602 ▲ | Lid - 4 qt (fits 0304) | 30 | 12 ea |

NSF Listed products are designated with a ▲ and may be prefixed with an N



Supreme

- Same features as our Classic Crock, but with a 1.5" deep rim
- Gives a stylish bowl-like appearance when dropped into food bar templates
- 6.5" diameter (under rim) fits most template openings
- Translucent snap-on lids included
- NSF Listed; dishwasher safe



Gourmet

- Unique bowl shaped rim with deep crock base
- Stylish frosted pattern on rim helps hide scratches
- Break-resistant polycarbonate takes heat up to 212°F
- Translucent snap-on lids included
- NSF Listed; dishwasher safe



Find replacement parts at www.carlislefsp.com/replacement-parts



| Prod No | Description | Color | Pack |
|----------------------|--|--------|-------|
| Supreme Cocks | | | |
| 0365 Δ | 1.5 qt Supreme Crock with Lid | 03, 07 | 6 ea |
| 0372 Δ | 2.7 qt Supreme Crock with Lid | 03 | 6 ea |
| 0202 Δ | Replacement Lid - 1.5/2.7 qt (fits 0365, 0372) | 30 | 12 ea |
| Gourmet Cocks | | | |
| 7039 Δ | Gourmet Crock with Lid | 03, 07 | 6 ea |
| 7038 Δ | Replacement Lid | 30 | 12 ea |

NSF Listed products are designated with a Δ and may be prefixed with an N



COLOR-COORDINATED ACCESSORIES

Carlisle has the **largest selection of color coordinated accessories** to complement our Food Bar, Buffet and Deli Items. **One-piece construction** makes Carlisle accessories more **durable and easier to clean**. Carlisle offers color-coordinated accessories for every kitchen application from **high heat to portion control**.

Tongs

Carly® Tongs

- Carries a two-year limited warranty
- Made of revolutionary plastic material for strength and longevity
- Can be used on high temperature surfaces like steam tables
- Withstands heat up to 212°F
- NSF Listed; dishwasher safe



Clear Carly Tongs

- Break-resistant polycarbonate
- Recommended for temperatures up to 212°F
- NSF Listed; dishwasher safe



| Prod No | Description | Color | Pack |
|---|------------------------|------------------------|-------|
| Carly Tongs | | | |
| 4606 ▲ | 6" Carly Salad Tong | 01, 02, 03, 05, 06 | 12 ea |
| 4609 ▲ | 9" Carly Salad Tong | 01, 02, 03, 05, 06, 08 | 12 ea |
| 4709 ▲ | 9" Carly Utility Tong | 01, 02, 03, 05, 06, 08 | 12 ea |
| 4712 ▲ | 12" Carly Utility Tong | 01, 02, 03, 05, 06 | 12 ea |
| 4806 ▲ | 6" Carly Pom Tong | 01, 03, 06 | 12 ea |
| Clear Carly Tongs | | | |
| 4006 ▲ | 6" Carly Salad Tong | 07 | 12 ea |
| 4009 ▲ | 9" Carly Salad Tong | 07 | 12 ea |
| 4109 ▲ | 9" Carly Utility Tong | 07 | 12 ea |
| 4206 ▲ | 6" Carly Pom Tong | 07 | 12 ea |

NSF Listed products are designated with a ▲ and may be prefixed with an N



Ladles

Carly Ladles

- Two-year limited warranty
- 1 ounce, oval-shaped bowl allows pouring from both sides
- Available in 9.5" and 13.5" lengths
- NSF Listed; dishwasher safe

Standard Ladles

- Two-year limited warranty
- .75 ounce bowl with spouts on each side for easy pouring
- Available in 10.5" length
- NSF Listed; dishwasher safe

Serving Spoons, Buffet Spoons & Pasta Forks

- Two-year limited warranty
- Recommended for temperatures up to 212°F
- Withstands dry heat up to 270°F
- Serving Spoons have notch in handle so spoon can rest on edge of food pan
- NSF Listed; dishwasher safe

Salad Spoon

- Large flat edge for easy scooping
- 7.25" handle for easy reach
- Durable SAN material
- NSF Listed; dishwasher safe



| | | | | | | |
|-----------|-----------|-----------|---------|-----------|-----------|------------------|
| Brown(01) | White(02) | Black(03) | Red(05) | Beige(06) | Clear(07) | Forest Green(08) |
|-----------|-----------|-----------|---------|-----------|-----------|------------------|

| Prod No | Description | Color | Pack |
|--------------------------------|---|----------------------------|-------|
| Ladles | | | |
| 0295 Δ | 9.5" Carly Ladle | 01, 02, 03, 05, 06, 07 | 12 ea |
| 0296 Δ | 13.5" Carly Ladle | 03 | 12 ea |
| 0287* | 9.5" Carly Ladle (Assorted Imprinted) | 03 | 1 set |
| 0240 Δ | 10.5" Standard Ladle | 03, 07 | 48 ea |
| 0261* | 10.5" Standard Ladle (Assorted Imprinted) | 03 | 1 set |
| Spoons & Pasta Fork | | | |
| 4410 Δ | 11" Solid Serving Spoon | 02, 03, 05, 06, 07, 08 | 12 ea |
| 4411 Δ | 11" Perforated Serving Spoon | 03, 07 | 12 ea |
| 4420 Δ | 13" Solid Serving Spoon | 02, 03, 05, 06, 07 | 12 ea |
| 4421 Δ | 13" Perforated Serving Spoon | 03 | 12 ea |
| 4430 Δ | 15" Solid Serving Spoon | 03, 07 | 12 ea |
| 4431 Δ | 15" Perforated Serving Spoon | 03 | 12 ea |
| 4450 Δ | .25 oz, 8" Solid Buffet Spoon | 03, 06, 07 | 12 ea |
| 4460 Δ | .5 oz, 8" Solid Buffet Spoon | 01, 02, 03, 05, 06, 07, 08 | 12 ea |
| 4470 Δ | .75 oz, 10" Solid Buffet Spoon | 01, 03, 05, 06, 07 | 12 ea |
| 4471 Δ | .75 oz, 10" Perforated Buffet Spoon | 01, 03, 06 | 12 ea |
| 4355 | 9.5" Pasta Fork | 03 | 12 ea |
| 509 Δ | 11" Salad Spoon | 01, 03 | 48 ea |

NSF Listed products are designated with a Δ and may be prefixed with an N
 Note:*Assortment Packs includes one each of Bleu Cheese, Lo-Cal, Italian, House, French, Ranch, Thousand Island, & Caesar, plus four plain Imprinted Ladles: Handle imprinted in white with dressing name



FOOD BARS

The Maximizer Food Bar enables you to **serve food anywhere!** Perfect for use with Coldmaster® Food Pans to keep food **below 40° for up to 8 hours.**

7711

Maximizer™ Food Bar

- 6 foot Maximizer Food Bar offers upscale European styling
- Use with ice or with Coldmaster® Standard Food Pans to keep food at 40°F or below for up to eight hours
- Double-sided, acrylic sneeze guard attaches to post with six screw-in knobs
- Basin and cabinet come assembled (no tools required)
- Tilting sneeze guard makes it easier to clean and fill food bar and can be used as a service line sandwich bar
- NSF Listed



Tilting sneeze guard



Holds six full size food pans (20% more than any other similar system)



Adapter Bars

Use with various food pans to set up a number of food bar configurations, see page 225 for more information

Maximizer Food Bar Coupon Available
www.carlislefsp.com/ecoupons

Find replacement parts at
www.carlislefsp.com/replacement-parts

Molded from durable polyethylene and filled with thick polyurethane foam to keep food at correct serving temperatures for hours



| Prod No | Description | Color | Pack |
|---|---------------------------|-------------------|------|
| Maximizer Food Bar & Accessories | | | |
| 7711 Δ | 6 ft Maximizer Food Bar | 01*, 03, 08*, 59* | 1 ea |
| 7721 Δ | 6 ft Maximizer Tray Slide | 01*, 03, 08, 59 | 1 ea |
| 7725 Δ | Maximizer End Shelf | 01, 03, 08*, 59* | 1 ea |

NSF Listed products are designated with a Δ and may be prefixed with an N
 * Color available by special order only



FOOD BARS

Features **high-tech coating** to keep the Six★Star Food Bar **looking great for years** to come and provides **easy clean up.**

Six★Star™ Food Bars

- Molded with thick polyurethane foam for hours of insulation
- Use with ice or with Coldmaster® Standard Food Pans to keep food at 40°F or below for up to eight hours
- Two-piece acrylic shields allow for easy assembly
- Specially coated finish gives a beautiful glossy sheen and makes clean up easier
- Faucet-type drain plug facilitates water removal
- Add tray slides and end shelves without removing legs
- Sturdy, recessed, 5" non-marking swivel casters, two with brakes
- Easy to assemble
- NSF Listed



6605 with 6620 Tray Slide

Portable Food Bars

- Legs only unit available in 4 or 6 foot models



6608 with 6621 Tray Slide

Youth Bar

Set up a Sundae Station using our Cold Master 3 gallon Ice Cream Server and crocks filled with all the fixins'

- Low 29" serving height is designed for young people to conveniently reach all condiments



6600

Tabletop Bars

Perfect for a Happy Hour Bar!

- Threaded drain plug underneath ice pan for easy water removal

6611 with 6621 Tray Slide 6625 End Shelf





Portable Enclosed Bars

- 6 foot unit with enclosed storage unit and sliding doors

Find replacement parts at
www.carlislefsp.com/replacement-parts



| Prod No | Description | Color | Pack |
|---|--|-------------------|------|
| Six★Star Food Bars & Accessories | | | |
| 6600 ▲ | 4 ft Six★Star Tabletop | 01*, 03, 05*, 08* | 1 ea |
| 6601 ▲ | 6 ft Six★Star Tabletop | 03 | 1 ea |
| 6605 ▲ | 4 ft Six★Star Portable with Legs only | 01*, 03, 08* | 1 ea |
| 6606 ▲ | 6 ft Six★Star Portable with Legs only | 01*, 03, 08* | 1 ea |
| 6611 ▲ | 6 ft Six★Star Portable with Storage & Legs | 03, 08* | 1 ea |
| 6608 ▲ | 6 ft Six★Star Youth with Legs only | 03, 05*, 08* | 1 ea |
| 6620 ▲ | 4 ft Six★Star Tray Slide (fits 6605) | 01, 03, 08* | 1 ea |
| 6621 ▲ | 6 ft Six★Star Tray Slide (fits 6606, 6608, 6611) | 01*, 03, 05*, 08* | 1 ea |
| 6625 ▲ | Six★Star End Shelf (fits all Six★Star Food Bars) | 01*, 03, 05*, 08* | 1 ea |

NSF Listed products are designated with a ▲ and may be prefixed with an N

Note: 6621 can ship UPS/FedEx Ground at oversize cost; 6600, 6601, 6608, 6611, 6605, 6606 cannot ship UPS/FedEx Ground

Note: 6600, 6601 tabletop units cannot be converted to portable units

* Color available by special order only



FOOD BARS & ACCESSORIES

Set up a counter top buffet pasta or salad station at your next event.
Perfect for happy hour in the bar!

Five★Star™ Buffet Bars

- Thick polyurethane foam insulation holds ice for hours
- Great with crocks, bowls or icing down beverages
- Drain plug at end of unit
- NSF Listed



7670 with 9720 Sneeze Guard

Find replacement parts at
www.carlislefsp.com/replacement-parts



| Prod No | Description | Color | Pack |
|---|---|-------------|------|
| Five★Star Buffet Bars | | | |
| 7670 ▲ | 4 ft Five★Star Buffet Bar | 01, 03, 08* | 1 ea |
| 7671 ▲ | 6 ft Five★Star Buffet Bar | 01*, 03 | 1 ea |
| Free Standing Single-Sided Sneeze Guards | | | |
| 9148 ▲ | 48" Standard Single-Sided | 03, 07 | 1 ea |
| 9160 ▲ | 60" Standard Single-Sided | 03, 07 | 1 ea |
| 9172 ▲ | 73.25" Standard Single-Sided | 03, 07 | 1 ea |
| 9224 | 24" Adjustable Single-Sided | 03, 07 | 1 ea |
| 9248 | 48" Adjustable Single-Sided | 03, 07 | 1 ea |
| 9260 | 60" Adjustable Single-Sided | 03, 07 | 1 ea |
| 9272 | 73.25" Adjustable Single-Sided | 03, 07 | 1 ea |
| Free Standing Double-Sided Sneeze Guards | | | |
| 9710 | 48" Standard Double-Sided | 03 | 1 ea |
| 9712 | 73.25" Standard Double-Sided | 03 | 1 ea |
| 9720 | 48" Adjustable Double-Sided | 03 | 1 ea |
| 9722 | 73.25" Adjustable Double-Sided | 03 | 1 ea |
| Sneeze Guard Accessories | | | |
| 9051 | Single End Panel (encloses side area on Single Sneeze Guard) | 07 | 1 pr |
| 9052 | Double End Panel (encloses side on Double-Sided Sneeze Guard) | 07 | 1 ea |

NSF Listed products are designated with a ▲ and may be prefixed with an N

Sneeze guards not recommended for use with steam tables

Shipping Notes: 7671 cannot be shipped UPS/FedEx Ground; 7670 can ship at oversize cost

9160, 9172, 9260, 9272, 9712 cannot be shipped UPS/FedEx Ground; 9148, 9248, 9710, 9720 can ship at oversize cost

* Color available by special order only



Sneeze Guards

- Designed to fit Five★Star Buffet Bars
- 9148, 9160, 9172 are NSF Listed



9260



9148

Pastry Display Cases

- Display pies, cookies and cakes
- Slide-in trays are textured to resist scratching
- Made of sanitary, easy-to-clean acrylic
- Convenient hinged door with magnetic closure



SPD303KD

Clear(07)

| Prod No | Description | Color | Pack |
|-----------------------------|--|-------|------|
| Pastry Display Cases | | | |
| SPD300 | Three Tray (Back Door) | 07 | 1 ea |
| SPD300KD | Three Tray (Back Door) (unassembled) | 07 | 1 ea |
| SPD303 | Three Tray, Self Serve Front & Back Door | 07 | 1 ea |
| SPD303KD | Three Tray, Self Serve Front & Back Door (unassembled) | 07 | 1 ea |
| SPD123 | Tray Only | 07 | 1 ea |

Pastry Display Cases listed above can be shipped UPS/FedEx Ground at oversize cost with the exception of SPD123 shipping at standard rate



CONDIMENT SOLUTIONS

Packet Racks

- Packet Racks hold all types of condiment packets, utensils, straws, napkins and take up very little counter space
- Choose between a sturdy aluminum frame or an economical chrome wire frame
- Durable plastic containers have a drop-in card holder molded into the front
- Unit comes with a set of 31 common label cards for organizing and identifying contents
- For use on counter or mount to wall with screws (included)



381206LG



381109LG

Food Stations

Condiment Food Station

- 10806 Condiment Station includes (4) sixth-size 6" deep, StorPlus™ polycarbonate black food pans
- Can also hold (4) sixth-size Coldmaster® standard food pans sold separately on page 111

Multi-Purpose Food Station

- 10807 Multi-Purpose Station includes (4) third-size 4" deep, StorPlus™ polycarbonate black food pans
- Can also hold (4) third-size Coldmaster® standard food pans sold separately on page 111



10806

10807

Standard Pump Kit

- 38310 Includes Standard Pump and the following 5 lid sizes: 1.5", 4.31", 4.31"SP, 4.69" and 6.31"
- Pump and lid sets screw or snap on allowing you to pump condiments directly from their containers
- Standard Plastic Pump has 2 restrictor clips for dispensing either .5 or 1 ounce portions



38310

Find replacement parts at www.carlislefsp.com/replacement-parts

Black(03)

Prod No **Description**

Color

Pack

Packet Racks

381109LG Aluminum Packet Rack, comes with 9 ea 3.5 qt containers

—

1 ea

381206LG Wire Packet Rack, comes with 6 ea 4 qt containers

—

1 ea

Food Stations

10806 ♦ Condiment Food Station (includes 4ea Sixth Size Food Pans)

03

1 ea

10807 Multi-Purpose Food Station (includes 4ea Third Size Food Pans)

03

1 ea

Standard Pump Kit

38310 Standard Pump Kit

—

6 ea

♦ California Residents: Bisphenol A **WARNING:** See appendix A on page 1



Carlisle topping rails, made of long lasting stainless steel, are perfect for dispensing condiments, dressings and sauces.

Standard Topping Rails

- Economical Standard Plastic Pump comes with 2 restrictor clips for dispenses either .5 or 1 ounce portions
- Removable pumps and jars included
- Rubber feet protect counter and slipping



38502

Insulated Topping Rails

- Insulated unit combines with reusable ice packs to keep condiments chilled for hours
- Includes reusable ice packs, 2 quart containers, pumps and self-adhesive labels of most popular condiments
- 2 quart containers include snap-on lids for overnight storage
- Choose between patented* Stainless Steel Pump or economical Standard Pump
- Stainless Steel Pump dispenses 1.25 ounces per stroke; Standard Pump dispenses .5 or 1 ounce portions



386230IB



386231B

High Volume Condiment Pumps

- Holds gallon jars or #10 cans for clean look
- Choose between patented* Stainless Steel Pump or Fixed Nozzle Pump
- Stainless Steel Pump dispenses 1.25 ounce per stroke; Standard Pump dispenses .5 or 1 ounce portions



386010



38601

Find replacement parts at www.carlislefsp.com/replacement-parts

| Prod No | Description | Pack |
|------------------------------------|--|------|
| Standard Pump Topping Rails | | |
| 38502 | Topping Rail with 2 ea Standard Pumps & Jars | 1 ea |
| 38503 | Topping Rail with 3 ea Standard Pumps & Jars | 1 ea |
| 38504 | Topping Rail with 4 ea Standard Pumps & Jars | 1 ea |
| Insulated Topping Rails | | |
| 386230IB | Insulated Topping Rail with 3 ea Stainless Steel Pumps & 2 Large Ice Packs | 1 ea |
| 386231B | Insulated Topping Rail with 3 ea Standard Pumps & 2 Large Ice Packs | 1 ea |
| High Volume Condiment Pumps | | |
| 386010 | High Volume Condiment Pump with Stainless Steel Pump | 1 ea |
| 38601 | High Volume Condiment Pump with Fixed Nozzle Pump | 1 ea |

*US Patent Nos. 6343720, 6019256, 6450373



CUP & LID DISPENSERS

Adjustable Cup Dispensers

- One dispenser to fit all standard sizes of foam, paper or plastic drink cups from 8 to 48 ounces
- Vertical Cabinet Models are made of rugged stainless steel
- Spring-loaded with silicone release gaskets
- Comes with four interchangeable gaskets per tube (small, medium, large and extra large)
- No tools required; ready to use



38800GLC



38882G



38850GEW mounts directly into counter tops or walls (can be inserted into an existing template)

38883G



38884G



38820C



38830C

Gravity Feed Cup Dispensers

- Adjusts easily to fit various sizes of foam, paper or plastic cups
- Mounts on walls and includes 2-piece quick-release side mount bracket

| Prod No | Description | Pack |
|------------------------------------|---|------|
| Adjustable Cup Dispensers | | |
| 38882G | 2 Cup Dispenser, Vertical Cabinet Model | 1 ea |
| 38883G | 3 Cup Dispenser, Vertical Cabinet Model | 1 ea |
| 38884G | 4 Cup Dispenser, Vertical Cabinet Model | 1 ea |
| 38850GEW | Cup Dispenser only | 1 ea |
| Gravity Feed Cup Dispensers | | |
| 38820C | Small Cup Dispenser, holds 6-11 oz, 2.5" - 3.44" cups | 1 ea |
| 38830C | Large Cup Dispenser, holds 12-24 oz, 3.38" - 3.88" cups | 1 ea |



Lid & Condiment Organizer

- Stainless Steel Organizer mounts on top of Vertical Cup Dispenser Cabinets or can be used on counter tops
- Rubber feet prevent slipping and protect counter
- Includes (2) pint & (3) quart plastic inserts



Counter Top Lid & Straw Dispenser

- Dividers adjust to accommodate all standard size lids
- Straw panel is removable for additional lid storage
- Rubber feet protect counter tops
- Dispenser can be wall mounted on two standard key-lock holes



6-Compartment Condiment Caddy

- Compact 8" x 14" size fits counter tops and coffee cabinets with limited space
- Stepped design with deep compartments for organizing condiments
- Durable ABS plastic with textured finish hides scratches



Dispensers

- Sliding tops for easy loading

Toothpick Dispenser

- Holds standard box of toothpicks
- Security cable prevents theft

Straw Dispenser

- Holds a full box of regular or jumbo unwrapped straws up to 8.5" long
- Easy turn knob dispenses one straw at a time

Find replacement parts at www.carlislefsp.com/replacement-parts



| Prod No | Description | Color | Pack |
|--|--|-------|-------|
| Lid & Condiment Organizer | | | |
| 38800GLC* | Lid/Condiment Organizer | — | 1 ea |
| Counter Top Lid & Straw Dispenser | | | |
| 388804L | 4 Station Counter Dispenser | — | 1 ea |
| 6-Compartment Condiment Caddy | | | |
| 10828 | 6-Compartment Coffee Service Condiment Caddy | 03 | 12 ea |
| Dispensers | | | |
| TP100 | Toothpick Dispenser | 07 | 1 ea |
| SSD100 | Straw Dispenser | 07 | 1 ea |

*Product available by special order only





BEVERAGE SERVICE

Perfect for restaurants and cafeterias!

TrimLine™ Rectangular Beverage Dispensers

- Sleek rectangular design saves valuable counter space
- Quart and liter capacity indicators on both sides
- Reservoir has ergonomic handles for a secure grip
- Features textured lid and base
- Hingeless lid minimizes breakage and helps prevent spills
- Removable Drip Tray prevents spills and saves on clean-up time
- Choose super tough crystal clear polycarbonate or economical translucent polypropylene
- Premium Dispenser has deluxe, no-drip, locking faucet
- Economy Dispenser has industry standard, no-drip faucet
- Includes labels: Fruit Punch, Iced Tea, Lemonade, Sweetened Tea and Unsweetened Tea



10857

Find replacement parts at www.carlislefsp.com/replacement-parts

Black(03)

| Prod No | Description | Color | Pack |
|--|---------------------------------|-------|------|
| TrimLine Single Base – Compact 8" width (Includes 1 ea 3 gal dispenser) | | | |
| 10850 Δ \blacklozenge | 3 gal Premium (PC) Single Base | 03 | 1 ea |
| 10854 Δ | 3 gal Premium (PPY) Single Base | 03 | 1 ea |
| 10852 Δ \blacklozenge | 3 gal Economy (PC) Single Base | 03 | 1 ea |
| 10856 Δ | 3 gal Economy (PPY) Single Base | 03 | 1 ea |
| TrimLine Double Base – Compact 15.5" width (Includes 2 ea 3 gal dispensers) | | | |
| 10851 Δ \blacklozenge | 3 gal Premium (PC) Double Base | 03 | 1 ea |
| 10853 Δ \blacklozenge | 3 gal Economy (PC) Double Base | 03 | 1 ea |
| 10857 Δ | 3 gal Economy (PPY) Double Base | 03 | 1 ea |

NSF Listed products are designated with a Δ and may be prefixed with an N \blacklozenge California Residents: Bisphenol A **WARNING:** See appendix A on page 1

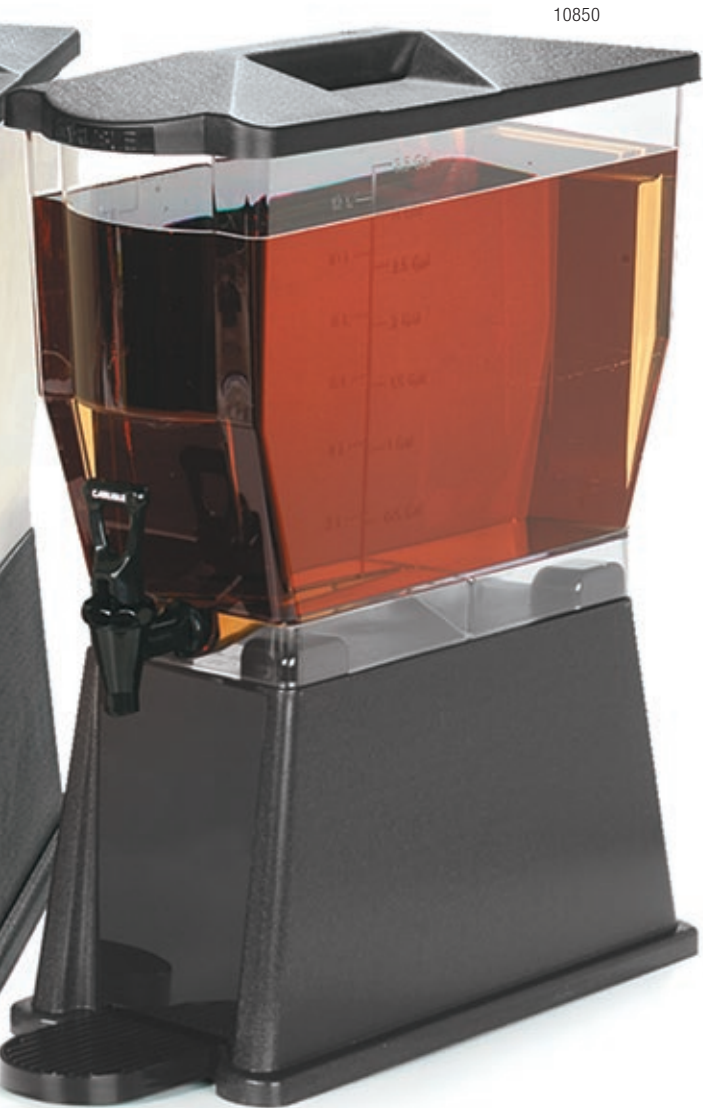

Square Beverage Dispenser

- Spring action faucet provides fast flow and dripless service

Round Beverage Dispensers

- Embossed measuring lines in 1-quart increments
- Dispensers and base sold as a unit or dispenser sold separately
- Includes labels for Iced Tea, Lemonade, Fruit Punch, Sweetened and Unsweetened Tea



| Prod No | Description | Color | Pack |
|--|--|--------|------|
| Square Beverage Dispenser | | | |
| 10820 | 3 gal Square (Translucent PPY) Dispenser with Base | 03 | 1 ea |
| Round Beverage Dispensers With Base | | | |
| 2230 | 5 gal Round (White PE) Dispenser with Base | 01 | 1 ea |
| 2229 | 5 gal Round (Translucent PPY) Dispenser with Base | 01, 03 | 1 ea |
| 2227 | 3 gal Round (Translucent PPY) Dispenser with Base | 01 | 1 ea |
| Round Beverage Dispensers | | | |
| 2210 | 5 gal Round (White PE) Dispenser | 02 | 1 ea |
| 2209 | 5 gal Round (Translucent PPY) Dispenser | 30 | 1 ea |
| 2219 | 3 gal Round (Translucent PPY) Dispenser | 30 | 1 ea |



CARLISLE
FOODSERVICE PRODUCTS

EFFICIENT STURDY INNOVATIVE SANITARY **BAR SUPPLIES**

Carlisle's extensive line of bar supplies enables your serving team to operate a more efficient and profitable bar operation with consistent quality for your patrons. Our efficient, time-saving bar essentials, Store 'N Pour containers and caddy systems save you time and money.





MAXIMIZER™ PORTABLE BAR

Delight your guests and increase revenue. Maximizer enables you to give your guests the bar service they want and expect. It's great for anything from banquet rooms and hotel lobbies to poolside bars and terrace dining.

Maximizer Portable Bar

- Maximizer offers all the style and features you expect in a premium bar at a very affordable price
- Large 56" serving area keeps condiment caddies within reach without blocking prep area
- Durable solidly molded countertop is easy to clean and includes a convenient molded-in bar mat well
- Sturdy 5" non-marking swivel casters with locking brake on each end hold the bar securely in place during use
- 15-gallon ice bin features an integrated drain and water trap
- Ice bin includes a standard dust cover for sanitary storage and transport
- Fully assembled, no tools necessary
- Find replacement parts at www.carlislefsp.com/replacement-parts

Maximizer Cover

- Protective 8 gauge vinyl cover keeps bar clean and dry when not in use
- Double vented back secures with hook and loop tape for a custom fit
- Tape fastening allows easy access to bar storage area without removing cover

See our money saving coupon online at www.carlislefsp.com/ecoupons



7555 Protective vinyl cover keeps bar clean and dry when not in use



Vented back for easy access

Ergonomic 2-step bar and countertop is designed for ease of drink preparation and serving; large surface area keeps condiment caddies within reach without blocking the prep area.



Designed by bartenders, Maximizer Portable Bar's upscale styling fits in any setting to enable profitable, efficient bar offerings that delight your guests with their favorite libations.



Maximizer Portable Bar's upscale styling is at home in any setting



Durable Maximizer Portable Bar is perfect for outdoor service



Built in cutting board for easy condiment preparation; can be removed for thorough cleaning



Storage compartment includes molded-in rails; use with StorPlus™ 12" x 18" Food Storage Boxes



Includes standard 22" Stainless Steel Speed-Rak™; holds 6 bottles or 6 Store 'N Pour® Quart containers



Unique sliding storage drawer accommodates mixers, sodas or standard bus boxes and can be removed for more versatile storage



Large storage area under the drawer is perfect for staging glassware using our OptiClean™ Glass Racks



| Prod No | Description | Color | Pack |
|---------|------------------------|-------------|------|
| 7550 | Maximizer Portable Bar | 03, 44, 094 | 1 ea |
| 7555 ♦ | Maximizer Bar Cover | 80 | 1 ea |

Find replacement parts at www.carlislefsp.com/replacement-parts

Note: 7550 cannot ship UPS/FedEx Ground

♦ California Residents: Di(2-ethylhexyl)phthalate (DEHP) **WARNING:** See appendix B on page 1



STORE 'N POUR®

Store 'N Pour

- Enjoy the benefits of the most efficient storing and pouring system for the bar, kitchen or dining room
- Pour a perfect 2-1 drink every time with the patented vented spout design
- Two-piece spout and neck design for easy cleaning
- Exclusive manufacturing process ensures tight seal with no leaks
- Made of high density, break-resistant polyethylene
- Easy clean containers have straight wall design with no sharp interior edges that can collect food or bacteria
- Unique stacking ridge on quart and pint caps make storage on shelf in refrigerator easy and secure
- Color-coordinated spouts and caps for easy product identification
- Lids snap on exclusive, recessed base of pints and quarts to prevent loss
- Assorted cap colors promote color-coding

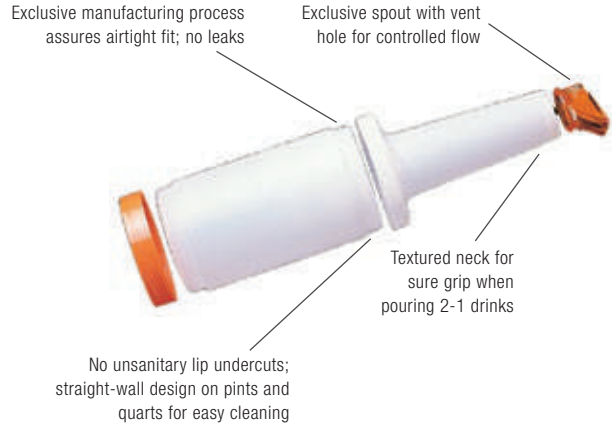

Back of House Store 'N Pour
 Our Store 'N Pour bottles and pourers can also be used in back of the house applications:

- Holding and pouring spices
- Cooking wine/sherry storage and usage

PourPlus PourPlus Complete

- Complete unit includes container, lid and spout

PourPlus Spout

- PourPlus fits all Store 'N Pour containers
- Integrated neck and spout designed for fast, free flowing pouring and easy clean-up
- Textured neck provides sure grip—even when wet
- Necks are color-coded



Store 'N Pour Versatility



Front-of-the-house use



Perfect 2-1 drinks are easy



Stackable backup storage



Back-of-the-house use



Pour batters and oils

Find replacement parts at www.carlislefsp.com/replacement-parts



| Prod No | Description | Color | Pack |
|----------------------------------|--------------------------|--------|-------|
| Store 'N Pour Speed Spout | | | |
| 3042 | Speed Spout | 07 | 24 ea |
| Pour Plus Store 'N Pour | | | |
| PS204 | PourPlus Spout | 02, 03 | 12 ea |
| PS204AST* | PourPlus Spout, Assorted | 00 | 1 set |
| PS601NC | Quart Complete | 00, 02 | 12 ea |

*Assorted PourPlus quart packs include 2 each of all colors; half-gallon and gallon assorted packs includes 1 each of all colors

The Essential Drink Mix System



1. Mix In One-Gallon Container

Accurately measure and mix concentrate or powder in gallon containers. Its wide mouth eliminates the need for a funnel.



2. Cut Preparation Time

Prepare mixes and juices in advance using the gallon storage container. At peak periods simply empty into a quart backup.



3. Transfer To Quarts

Pour a gallon of mix into four easy-to-handle quart containers.



4. Ready To Use

Attach neck with spout to one quart for use in speed rack. Cap the remaining three quarts for backup.

Store 'N Pour Complete Units & Backups

- Complete unit includes neck and container plus color-coordinated pouring spout and cap
- Backup unit includes cap and container
- Dishwasher safe

Store 'N Pour Speed Spout

- No-drip spout is vented to promote faster, more even flow



3042



Store 'N Pour Bar Service Pack

Includes six quart complete units (container, neck and color-coordinated spout and cap), 18-quart backup units (container and cap) and 1-gallon backup unit (container with cap) for mixing



| | | | | |
|--------------|-----------|-----------|------------|------------|
| Assorted(00) | Brown(01) | Black(03) | White(02) | Yellow(04) |
| Red(05) | Clear(07) | Green(09) | Orange(24) | |

| Prod No | Description | Color | Pack |
|---|--------------------------------|----------------------------|-------|
| Store 'N Pour Complete Units & Backups | | | |
| PS501N | Pint Complete | 00 | 12 ea |
| PS502N | Pint Backup | 00 | 12 ea |
| PS601N | Quart Complete | 00, 01, 02, 04, 05, 09, 24 | 12 ea |
| PS602N | Quart Backup | 00, 02, 04, 05, 09, 24 | 12 ea |
| PS701B | Half-gallon Complete | 00 | 6 ea |
| PS702 | Half-gallon Backup | 00 | 6 ea |
| PS801B | Gallon Complete | 00 | 6 ea |
| PS802 | Gallon Backup | 00 | 6 ea |
| PS103 | Spouts, Specify Color | 01, 04, 05, 07, 24 | 12 ea |
| PS103AT | Spout Assortment, 2 ea color | 00 | 12 ea |
| PS203 | Necks | 02 | 12 ea |
| PS304 | Caps, Specify Color | 01, 02, 03, 04, 05, 24 | 12 ea |
| PS304AT | Caps, Assortment, 2 ea color | 00 | 12 ea |
| PS603N | Quart, Container Only | 02 | 12 ea |
| Store 'N Pour Bar Service Pack | | | |
| PS6012 | Store 'N Pour Bar Service Pack | 00 | 1 set |
| Store 'N Pour Speed Spout | | | |
| 3042 | Speed Spout | 07 | 24 ea |

*Assorted PourPlus quart packs include 2 each of all colors; half-gallon and gallon assorted packs includes 1 each of all colors



BOTTLE HOLDERS & CONDIMENT CADDIES

Stainless Steel Speed-Rak™ Bottle Holders

- Keyhole slots make installation and cleaning easy
- Mounts to bar sink with screws (provided)
- Unique design; single Speed-Raks can be combined to make a double-hung unit



38322BH
Combine to make a
double-hung unit

Find replacement parts at
www.carlislefsp.com/replacement-parts

| Prod No | Description | Pack |
|---|---|------|
| Stainless Steel Speed-Rak Bottle Holders | | |
| 38322BH | 22" Speed-Rak, holds (5) 1-liter bottles | 2 ea |
| 38332BH | 32" Speed-Rak, holds (8) 1-liter bottles | 2 ea |
| 38342BH | 42" Speed-Rak, holds (10) 1-liter bottles | 2 ea |

Condiment Caddies

Stainless Steel Caddies

- Rugged stainless steel construction for years of use
- Full size hinged lid units protect condiments from spills and contaminants
- Individual compartment lids keep contents covered when not in use
- Notched lid models available for use with spoons or ladles
- Sanitary pint & quart inserts are easy to clean; (2) pints interchange with (1) quart, allowing you to mix and match to suit your needs



Stainless Steel Iced Caddies

- Insulated caddies use ice packs to keep condiments chilled and cold for hours without ice or electricity

Deluxe Caddies

- Solid frosted cover
- Includes caddy and individual containers

Plastic Caddies

- Solid frosted cover
- Includes caddy and individual containers



White(02)

| Prod No | Description | Color | Pack |
|--|--|-------|------|
| Stainless Steel Condiment Caddies | | | |
| 38704CNS | 4 qt Condiment Caddies with 4 Lids | — | 1 ea |
| 38704CSIB | 4 qt Condiment Caddies with 4 Notched Lids & 4 Ice Packs | — | 1 ea |
| 38704C | 4 pt Condiment Caddies with One-Piece Lid | — | 1 ea |
| 38705C | 5 pt Condiment Caddies with One-Piece Lid | — | 1 ea |
| 38706C | 6 pt Condiment Caddies with One-Piece Lid | — | 1 ea |
| Plastic Condiment Caddies | | | |
| SS105 | Caddy with 5 ea 1.25 Pint Containers/Lids | 02 | 1 ea |



BAR ACCESSORIES

Bar Caddy

- Ideal bar-top holder that allows quick access to cocktail napkins, stirrers and other accessories
- Break-resistant plastic



Store 'N Pour® Condiment System

- Condiment system includes tray with cover and six pint containers (PS502N) with assorted caps
- Assorted color caps provide easy identification; caps snap on the bottom for easy storage
- Acrylic covers protect condiments during service



| Prod No | Description | Color | Pack |
|---------------------------------------|---------------------------|-------|-------|
| Bar Caddy | | | |
| BC05 | Bar Caddy | 03 | 12 ea |
| Store 'N Pour Condiment System | | | |
| PS101CS | Complete Condiment System | 00 | 2 ea |

Bar Mat & Service Mat

- Non-slip mats help keep counter tops clean
- Molded-in pattern provides drainage for spilled drinks and wash downs with a sure grip for wet glassware
- Bar Mats have drainage area for jigger, main area holds up to six glasses

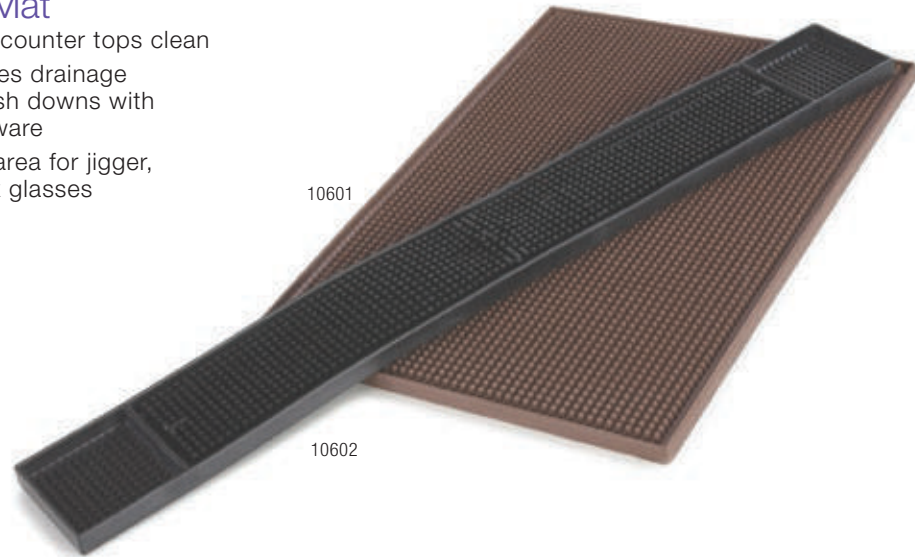

Bar & Shelf Liner

- Provides skid-resistance and high impact absorption; net pattern allows thorough drainage, promoting rapid, fog-free drying
- Helps prevent bacteria growth
- Resistant to food acids, grease and detergents; conforms to FDA regulations
- Constructed of a firm, resilient plastic



| Prod No | Description | Color | Pack |
|----------------------------------|------------------------|------------|-------|
| Bar Mat & Service Mat | | | |
| 10601 | 12" x 18" Service Mat | 01, 03 | 6 ea |
| 10602 | 3" x 27" Bar Mat | 01, 03 | 12 ea |
| Bar & Shelf Liner | | | |
| 3210 | 2' x 40' Texliner Roll | 01, 03, 07 | 1 ea |
| 3211 | 2' x 10' Texliner Roll | 03, 07 | 1 ea |



BAR ACCESSORIES

Glass Rimmers

Standard Glass Rimmer

- Two-tier unit provides consistent and even coat of salt

Combination Salt/Sugar Glass Rimmer

- Three-tier unit allows for application of either salt or sugar



Portion Control Liquor Pourers

- Carlisle offers portion control pourers in both ounce and metric measurements
- Classic design Portion Pour dispenses exact shots of liquor

Portion Pour®

- Portion Pour dispenses exact shots of liquor from 1 to 1.5 ounce
- Also available in 20ml metric size



Pour Free®

- Economical Pour Free for free-flow pouring



| Prod No | Description | Color | Pack |
|---|--------------------------------------|-------|-------|
| Glass Rimmers | | | |
| GR09 | 3-Tier Glass Rimmer | 03 | 12 ea |
| GR10 | 2-Tier Glass Rimmer | 03 | 12 ea |
| Portion Control Liquor Pourers With Red Spout/Black Collar | | | |
| EP214 | 1 oz Portion Pour with Red Base | 00 | 12 ea |
| EP216 | 1.25 Portion Pour with Clear Base | 00 | 12 ea |
| EP217 | 1.5 oz Portion Pour with Yellow Base | 00 | 12 ea |
| Pour Free | | | |
| OP305 | Fluorescent Red Pour Free | 00 | 12 ea |
| OP316 | Black Pour Free | 00 | 12 ea |
| OP371 | Chrome/Black Collar Pour Free | 00 | 12 ea |

Free Flowing Metal Liquor Pourers

- Sturdy metal construction and choice of three flow rates
- Chrome plated for attractive appearance and longer life

Pourer With Screen

- Metal style pourer with sanitary screen



Ice Scoops

- 606106 scoop is made of 18-8 rust-free mirror polished stainless steel
- 4306 is made of durable polycarbonate material for long lasting use
- Tapered for easy pouring of ice into glasses
- Both feature a hole for hanging or tying to a container
- Made of durable polycarbonate material for long-lasting use
- See page 199 for a complete listing of Carlisle's scoop line
- NSF Listed; dishwasher safe



| Prod No | Description | Color | Pack |
|---|--------------------------------|-------|-------|
| Metal Style Free Flowing Pourers | | | |
| WPM25 | Chrome Tapered with Screen | 38 | 12 ea |
| WPM85 | Chrome Tapered, Medium Flow | 38 | 12 ea |
| WPM45 | Chrome Angled, Super Fast Flow | 38 | 12 ea |
| Ice Scoops | | | |
| 606106 Δ | 6 oz Stainless Steel Bar Scoop | — | 24 ea |
| 4306 Δ \blacklozenge | 6 oz Polycarbonate Scoop | 07 | 12 ea |

NSF Listed products are designated with a Δ and may be prefixed with an N

\blacklozenge California Residents: Di(2-ethylhexyl)phthalate (DEHP) **WARNING:** See appendix B on w 1



BAR ACCESSORIES

Cocktail Shaker

- Bar Essential 18-8 mirror polished all stainless steel classic 3-piece shaker (608600) has a vented pour spout that reduces splashing and spills
- Units fit together snugly for no-mess shaking



608600

Wine Servers & Coolers

Double Walled Wine Coolers

- Double walled construction keeps bottles chilled for hours (no need to pre-chill cooler or use ice)
- Prevents damaging surface condensation
- 18-8 stainless steel is more durable than marble coolers; never requires polishing
- Choose satin or mirror polish finish
- 609144 and 609145 also accommodate champagne bottles
- Hand wash only



609143

Wine Buckets & Stands

- Wine buckets and stands enhance any fine dining experience
- Choice of standard or double size wine bucket
- Stands are 24" high with heavy, weighted bases to prevent accidental tipping
- 18-8 stainless steel never requires polishing
- Mirror polish finish, hand wash only



609107



609107

609146

| Prod No | Description | Pack |
|---|---|-------|
| Cocktail Shakers | | |
| 608600 | 30 oz Classic Cocktail Shaker | 12 ea |
| Double Walled Wine Servers & Coolers | | |
| 609143 | Double Wall Wine Cooler, Satin Finish with Mirror Finish Rim; 7.75" H | 1 ea |
| Wine Buckets & Stands | | |
| 609107 | Wine Bucket (fits 609146) | 4 ea |
| 609146 | 24" Wine Bucket Stand, 7.5" Dia | 1 ea |

Wine Server

- Wine Servers merchandise your wine selection
- Double-wall construction provides insulation to help keep wine at proper temperatures



Red Wine Holder

- Satin finish 18-8 stainless steel never requires polishing
- Two rings orbit above the base to create an easy carry handle; bottles snap into handle for secure pouring
- Hand wash only



Ice Buckets

- 18-8 stainless steel never requires polishing
- Double walled construction (609190, 609193) holds ice longer and prevents surface condensation
- 609190 has flat handle, hinged lid and comes complete with perforated drain tray and tong
- 609191 has mirror polished finish outside, satin finish inside, with knob handles
- 609193 has tubular handle and satin finish; complete with lid
- Hand wash only



Black(03)

| Prod No | Description | Color | Pack |
|------------------------------------|---|-------|-------|
| Acrylic Wine Servers | | | |
| IG224 | Acrylic Server with Black Base | 03 | 12 ea |
| Red Wine Holder | | | |
| 609106 | Red Wine Holder | — | 1 ea |
| Stainless Steel Ice Buckets | | | |
| 609190 | 1.5 qt Double Wall Ice Bucket with Tong | — | 1 ea |
| 609193 | 3.5 qt Double Wall Ice Bucket | — | 1 ea |
| 609191 | 1.7 qt Ice Bucket with Handle and Tong | — | 1 ea |



CARLISLE
FOODSERVICE PRODUCTS

PRACTICAL
ELEGANT
RUGGED
DURABLE
**FOODSERVICE
TRAYS**

Carlisle trays and accessories are designed to please your patrons and enable your staff to serve meals economically without sacrificing durability.

We set the standard for size, color selection, appearance and reliability.





FIBERGLASS TRAYS

Glasteel™ Trays

Glasteel trays offer durability and cleanability at an affordable price.

- Engineered to be the most durable fiberglass trays available
- Decorating options, see page 334 for additional information
- 5-year limited warranty
- NSF Listed; dishwasher safe

Heavy-Duty Construction

- Metal reinforcing rods provide extra strength and eliminate warping
- Two thick, reinforcing fiberglass core mats add strength and provide increased chemical resistance

Air Flow Corner Reinforcements

- Air flow corner reinforcements and stacking lugs make Glasteel trays your best choice for stability and drying when stacked
- Unique design permits air flow to all surfaces of stacked trays, reducing drying time

Fiberglass Trays are available in full cases only.

There is a NO-RETURN POLICY on Customized Fiberglass Trays.



Custom Decorating

Carlisle offers a decorating program so you can label your trays with a logo, image or any graphic visit www.carlislefsp.com/custom-imprinting for more information

Trapezoid

Space saving shape for better table fit



Image Wrap

Full color images printed on both sides of the tray*



Rectangular Regular & Low-Edge

Low-edge trays have “squared-off” corners to permit dish overhang, fitting more serving items on a given tray size

Display/Bakery

Ideal for displays and available in all colors and patterns



*Contact Customer Service at 1-800-654-8210 for more information



Available for immediate shipment in
Bone White(001), Natural(003),
Black(004) and Almond(095)

See pages 152-155 for available
tray sizes and colors

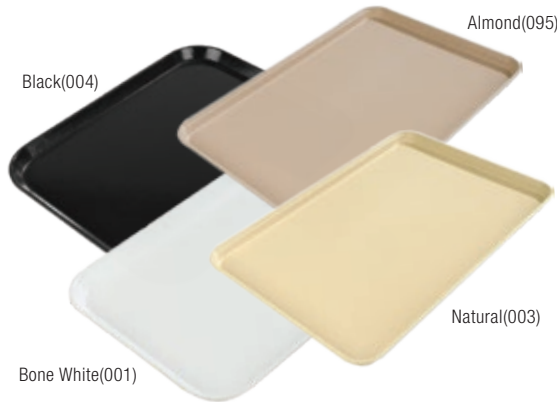

**Dimensions & Weights For Use With
Self-Leveling Dispensers**

| Prod No | Length | Width | Height of One | Height of 11 | Weight of 10 |
|---------|---------|---------|---------------|--------------|--------------|
| 1410FG | 13-3/4" | 10-5/8" | 3/4" | 3-5/16" | 9lb 2oz |
| 1612FG | 16-3/8" | 12" | 3/4" | 3-5/16" | 11lb 12oz |
| 1814FG | 18" | 14" | 3/4" | 3-1/2" | 14lb 4oz |
| 2015FG | 20-1/4" | 15" | 3/4" | 3-5/16" | 17lb |
| 2216FG | 22" | 16" | 1-1/8" | 4-1/8" | 21lb 8oz |
| 1713FG | 18" | 14" | 3/4" | 3-1/2" | 14lb 12oz |
| 2214FG | 22" | 14" | 3/4" | 3-5/16" | 15lb 2oz |

BOX INDICATES ITEM IS AVAILABLE FOR IMMEDIATE SHIPMENT IN OUR MOST POPULAR SIZES

Trapezoid Tray Table Planner

| | 1713 | 2214 |
|------------------------|------|------|
| 36" Square Table Holds | 4 ea | 4 ea |
| 42" Round Table Holds | 4 ea | 4 ea |
| 54" Square Table Holds | 6 ea | 6 ea |

| Prod No | Description | Pack |
|-----------------------|---------------------------|--------------------|
| Solid Color | Decorative Pattern | Wood Grain |
| Rectangular | | |
| 1410FG Δ | 1410DFG Δ | 1410WFG Δ |
| 1612FG Δ | 1612DFG Δ | 1612WFG Δ |
| 1814FG Δ | 1814DFG Δ | 1814WFG Δ |
| 2015FG Δ | 2015DFG Δ | 2015WFG Δ |
| 2216FGQ Δ | — | 2216WFGQ Δ |
| Low Edge | | |
| 1216LFG Δ | 1216LDFG Δ | 1216LWFG Δ |
| 1418LFG Δ | 1418LDFG Δ | — |
| 1219LFG Δ | 1219LDFG Δ | 1219LWFG Δ |
| 1520LFG Δ | 1520LDFG Δ | 1520LWFG* Δ |
| 1222LFG Δ | 1222LDFG Δ | 1222LWFG Δ |
| Display/Bakery | | |
| 269FG Δ | 269DFG Δ | 269WFG Δ |
| 1318FG Δ | 1318DFG Δ | — |
| 2618FGQ Δ | 2618DFGQ Δ | 2618WFGQ Δ |
| Trapezoid | | |
| 1713FG Δ | 1713DFG Δ | 1713WFG Δ |
| 2214FG Δ | 2214DFG Δ | 2214WFG Δ |
| Metric | | |
| 2310FG Δ | 2310DFG Δ | 2310WFG Δ |
| 1220FG Δ | 1220DFG Δ | 1220WFG Δ |
| 1212FG Δ | — | 1212WFG Δ |
| 2115FG Δ | 2115DFG Δ | 2115WFG Δ |
| 1419FG Δ | 1419DFG Δ | 1419WFG Δ |

NSF Listed products are designated with a Δ and may be prefixed with an N
See corresponding covers on page 160



GLASTEEL™ TRAY COLOR SAMPLES

BOX INDICATES ITEM IS AVAILABLE FOR IMMEDIATE SHIPMENT IN OUR MOST POPULAR SIZES

Solid Colors

001

Bone White

| | |
|----------|----------|
| 1410FG | 1222LFG* |
| 1612FG | 269FG* |
| 1814FG | 1318FG* |
| 2015FG | 2618FGQ |
| 2216FGQ* | 1713FG |
| 1216LFG* | 2214FG* |
| 1418LFG* | 1220FG* |
| 1219LFG* | 2115FG* |
| 1520LFG* | |

003

Natural

| | |
|--------|---------|
| 1410FG | 2216FGQ |
| 1612FG | 269FG* |
| 1814FG | 2618FGQ |
| 2015FG | 1713FG |

004

Black

| | |
|----------|----------|
| 1410FG | 1222LFG* |
| 1612FG | 269FG* |
| 1814FG | 1318FG* |
| 2015FG | 2618FGQ |
| 2216FGQ* | 1713FG |
| 1216LFG* | 2214FG* |
| 1418LFG* | 1220FG* |
| 1219LFG* | 1212FG* |
| 1520LFG* | |

095

Almond

| | |
|--------|---------|
| 1612FG | 2618FGQ |
| 1814FG | 1713FG |
| 2015FG | |

002

Smoke Gray

| | |
|----------|----------|
| 1410FG* | 1520LFG* |
| 1612FG* | 269FG* |
| 1814FG* | 1318FG* |
| 2015FG* | 2618FGQ* |
| 2216FGQ* | 1713FG* |
| 1418LFG* | 1220FG* |
| 1219LFG* | |

005

Pewter

| | |
|----------|----------|
| 2216FGQ* | 2618FGQ* |
| 1520LFG* | 2214FG* |

006

Ultramarine

| | |
|---------|----------|
| 1410FG* | 1219LFG* |
| 2015FG* | 1713FG* |

007

Tropical Green

| | |
|---------|----------|
| 1814FG* | 2216FGQ* |
| 2015FG* | 2618FGQ* |

008

Avocado

| | |
|----------|---------|
| 2216FGQ* | 1220FG* |
| 1713FG* | |

009

Lime

| | |
|----------|----------|
| 1410FG* | 269FG* |
| 1612FG* | 1318FG* |
| 1814FG* | 2618FGQ* |
| 2015FG* | 1713FG* |
| 2216FGQ* | 2214FG* |
| 1216LFG* | |

010

Forest Green

| | |
|---------|----------|
| 1410FG* | 1219LFG* |
| 1814FG | 1318FG* |
| 2015FG* | 2618FGQ* |
| 2216FGQ | 2214FG* |

011

Turquoise

| | |
|---------|----------|
| 1410FG* | 1219LFG* |
| 1814FG | 1318FG* |
| 2015FG* | 2618FGQ* |
| 2216FGQ | 2214FG* |

* Color available by special order only



Ice Blue

- 1612FG*
- 1814FG*
- 2015FG*
- 2216FGQ*
- 1520LFG*
- 2618FGQ*
- 1212FG*



Cobalt Blue

- 1410FG*
- 1612FG*
- 1814FG*
- 2015FG*
- 2216FGQ*
- 269FG*
- 1318FG*
- 2618FGQ*
- 1713FG*



Navy

- 1612FG*
- 1814FG*
- 2015FG*
- 2216FGQ*
- 1216LFG*
- 1418LFG*
- 2618FGQ*
- 1220FG*



Peach

- 2216FGQ*
- 2618FGQ*
- 1220FG*



Red

- 1410FG*
- 1612FG*
- 1814FG
- 2015FG*
- 2216FGQ*
- 1216LFG*
- 1418LFG*
- 269FG*
- 1318FG*
- 2618FGQ*
- 2214FG*



Orange

- 1410FG*
- 1814FG*
- 1520LFG*
- 269FG*
- 2618FGQ*
- 1713FG*



Rust

- 1612FG*
- 1814FG*
- 2216FGQ*



Coral

- 1612FG*
- 1814FG*
- 2618FGQ*
- 1713FG*
- 2214FG*



Pineapple

- 2618FGQ*
- 1713FG*
- 2214FG*



Ivory

- 1612FG*
- 1814FG*
- 2216FGQ*
- 1520LFG*
- 269FG*
- 2618FGQ*
- 1220FG*



Gold

- 1410FG*
- 1814FG*
- 2015FG*
- 2216FGQ*
- 269FG*
- 2618FGQ*
- 1713FG

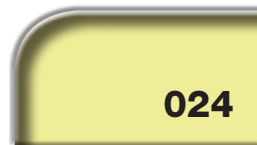

Lemon

- 2216FGQ*
- 2618FGQ*

* Color available by special order only

GLASTEEL™ TRAY COLOR SAMPLES

Solid Colors



025

Beige

1410FG* 1219LFG*
 1814FG* 2618FGQ*
 2015FG* 1713FG*
 2216FGQ* 1220FG*
 1418LFG*



050

Sapphire

1410FG* 1418LFG*
 1814FG* 2618FGQ*
 2015FG* 1713FG*
 2216FGQ* 2214FG*
 1216LFG*



051

Teal

1410FG* 2618FGQ*
 2216FGQ 2214FG*
 1520LFG*



052

Amethyst

2216FGQ* 1220FG*



053

Jade

1814FG* 2618FGQ*
 1220FG*



054

Mulberry

1410FG* 1612FG*
 1814FG*
 2216FGQ*



055

Rainforest Green

1814FG* 2015FG*



066

Mauve

1410FG* 1520LFG*
 1814FG* 269FG*
 2015FG* 2618FGQ*
 2216FGQ* 1713FG*



067

Slate Blue

1410FG* 2214FG*
 1814FG* 1419FG*
 1713FG*



068

Gray

1612FG* 1222LFG*
 1814FG 2618FGQ*
 2015FG 1713FG*
 2216FGQ



069

Raspberry

1814FG* 2618FGQ*
 2015FG* 1713FG*



076

Coffee Tan

1814FG* 2618FGQ*
 2216FGQ* 1713FG*

* Color available by special order only



Chocolate

- 1410FG*
- 1612FG*
- 1814FG*
- 2015FG*
- 2216FGQ*
- 1520LFG*
- 269FG*
- 1318FG*
- 2618FGQ*
- 1713FG*
- 2214FG*



Pacific Blue

- 1612FG*
- 1814FG*
- 1220FG*



Bay Leaf Brown

- 1814FG*
- 2015FG*



Cherry Red

- 1612FG*
- 2015FG*
- 2216FGQ*

Decorative Patterns



Starfire Gray

- 1814DFG*
- 1216LDFG*



Starfire Blue

- 1410DFG*
- 1418LDFG*



Starfire Natural

- 1814DFG*
- 2015DFG*
- 1418LDFG*
- 1713DFG*

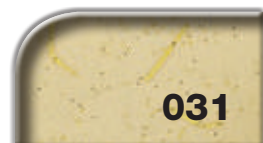

Starfire Beige

- 1418LDFG*

Wood Grain Patterns



Pecan

- 1814WFG*
- 2015WFG*
- 1216LWFG*
- 269WFG*



Light Oak

- 1520LWFG
- 269WFG*
- 1220WFG*



Butcher Block

- 1410WFG*
- 1814WFG*
- 1216LWFG*
- 1713WFG*



Redwood

- 1814WFG*
- 1713WFG*



SPECIALTY TRAYS

Carlisle offers a **broad assortment** of shapes and colors to ensure all your tray needs are met.

Fiberglass Market Trays & Pans

- Use for displaying breads, bakery items and sliced deli meat
- 2" deep pans for serving deli salads, pasta and desserts
- Trays have heavy-duty fiberglass construction and metal reinforced rods
- Air-flow corners reduce drying time
- NSF Listed



BOX INDICATES ITEM IS AVAILABLE FOR IMMEDIATE SHIPMENT IN OUR MOST POPULAR SIZES



| Prod No | Description | Color | Pack |
|--|-----------------------|------------------------------|-------|
| Fiberglass Market Trays | | | |
| 630FMT Δ | 30.00/6.44/0.75 | 309* | 12 ea |
| 830FMT Δ | 30.00/8.50/0.75 Tray | 301, 309 | 12 ea |
| 1030FMT Δ | 30.00/10.44/0.75 Tray | 301, 309 | 12 ea |
| 1230FMT Δ | 30.00/12.44/1.05 Tray | 301, 309 | 12 ea |
| 269FMT Δ | 8.75/25.50/1.12 Tray | 301, 309 | 12 ea |
| 1218FMT Δ | 17.75/11.44/0.75 Tray | 301, 309 | 12 ea |
| 1318FMT Δ | 17.75/12.75/1.00 Tray | 301, 309 | 12 ea |
| 2618FMTQ Δ | 17.87/25.62/1.25 Tray | 301, 302, 303, 304, 306, 309 | 6 ea |
| Fiberglass Market Pans | | | |
| 6302FMT Δ | 30.00/6.45/2.00 Pan | 301, 309 | 12 ea |
| 8302FMT Δ | 30.00/8.45/2.00 Pan | 301, 309 | 12 ea |
| 10302FMT Δ | 30.00/10.47/2.00 Pan | 301, 309 | 12 ea |

NSF Listed products are designated with a Δ and may be prefixed with an N



Café Trays

- Feature skid-resistant surface and drying/stacking lugs
- Custom hot stamping is available, see page 334 for additional information
- Economical & light-weight polypropylene
- NSF Listed



CT1014

CT1216

Standard Café Tray

- Traditional scratch-resistant basket weave design reduces slipping and helps prevent accidental spills

Trapezoid Café Tray

- Space saving shape allows diners to eat directly from trays without removing plates, cups, etc. from the tray
- Promotes self-bussing

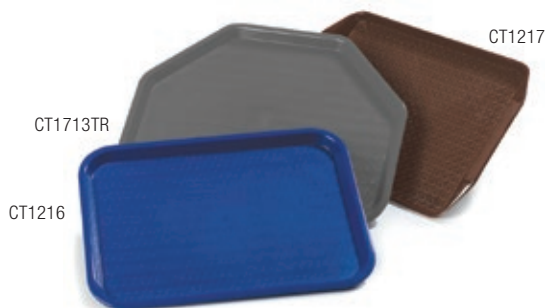

CT1217

CT1713TR

CT1216

Carlisle recommends hand washing for Café Trays

Handled Café Tray

- Handled tray is easy to carry and offers added strength

Bistro™ Trays

- Unique trays offer a great look at an economical price
- Durability and economy of our Café Trays with stylish curved handles for easy handling and added strength
- Scratch-resistant, textured design reduces slipping, helps prevent spills
- Drying and stacking lugs



1217BT

1319BT

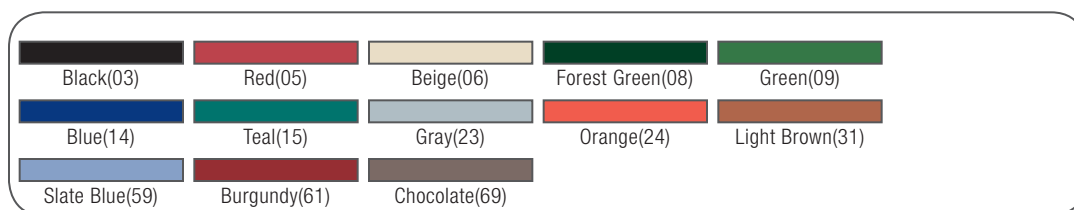

| Prod No | Description | Color | Pack |
|--|---------------------------------|--|-------|
| Café Trays | | | |
| CT1014 ▲ | 13.87/10.75/0.79 Standard Tray | 03, 05, 06, 08, 09, 14, 15, 23, 24, 61, 69 | 24 ea |
| CT1216 ▲ | 16.31/12.06/0.70 Standard Tray | 03, 05, 06, 08, 09, 14, 15, 23, 24, 31, 59, 61, 69 | 24 ea |
| CT1418 ▲ | 17.87/14.00/0.98 Standard Tray | 03, 05, 06, 08, 09, 14, 15, 23, 24, 31, 59, 61, 69 | 12 ea |
| CT1713TR ▲ | 18.00/14.00/0.81 Trapezoid Tray | 03, 06, 14, 23, 69 | 12 ea |
| CT1217 ▲ | 16.93/12.06/0.60 Handled Tray | 03, 05, 14, 69 | 24 ea |
| Bistro Trays | | | |
| 1217BT | 12" x 17" Bistro Tray | 03 | 12 ea |
| 1319BT | 13" x 19" Bistro Tray | 03 | 12 ea |

NSF Listed products are designated with a ▲ and may be prefixed with an N



COMPARTMENT TRAYS

Our Compartment Trays are the perfect **cost effective solution** for portion control.

6-Compartment Trays

- The 6-compartment trays hold government "Type A" lunch
- Carlisle offers the largest variety of sizes and compartment combinations available
- All materials are FDA approved and NSF Listed



Materials

Melamine

- Melamine is a heavy, rigid material with the look and feel of china
- It is very scratch- and break-resistant
- Fast drying melamine is highly resistant to chemicals and food acids with a temperature range of 0° to 212°F

Polycarbonate

- Money saving trays carry a five-year warranty against breakage
- Highly break-resistant; perfect choice for correctional facilities
- Polycarbonate offers good scratch- and chemical-resistance with a temperature range of -40° to 212°F

Polypropylene

- Economical, durable choice
- Good chemical resistance
- Temperature range of 30° to 180°F
- Handwashing is recommended

ABS

- Break- & scratch-resistant
- Excellent choice for general use
- Highly resistant to chemicals and food acids with a temperature range of 0° to 180°F

Orientations

Left & Right-Hand

- Offer a greater variety of serving combinations
- Available in melamine, polycarbonate, ABS and polypropylene
- NSF Listed, except when offered in Variegated(00)

Omni-Directional & Space Saver Trays

- Special design allows you to fit two trays side by side in dish rack for faster cycling time



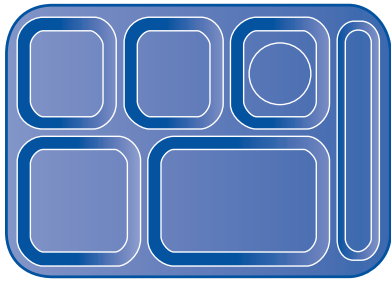

Right-Hand Tray
(43988, 43989, 614R, P614R)

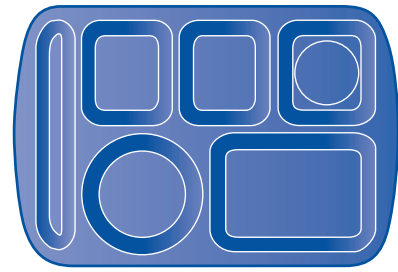

Handled Economy Left-Hand Tray
(5865)



Space-Saver Omni-Directional Tray
(615**)

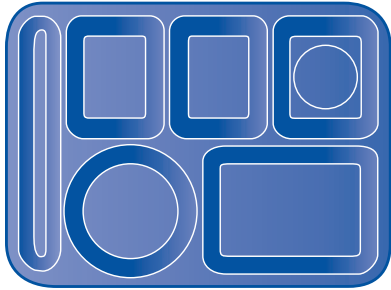

Left-Hand Tray
(43980, 43981, 614, P614, 614PC†)

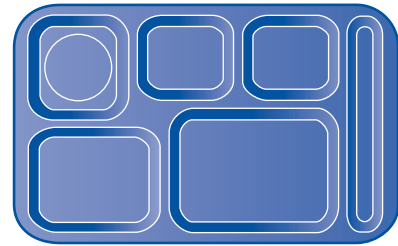

Space-Saver Right-Hand Tray
(43982, 43983)

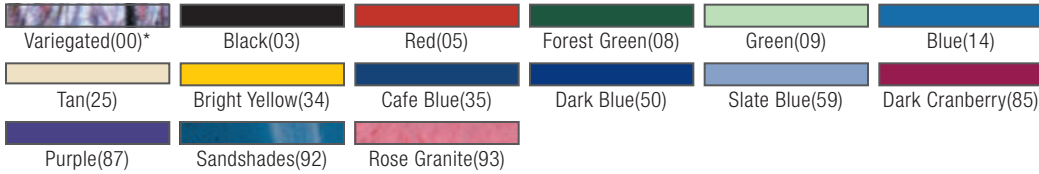

| Prod No | Description | Color | Pack |
|--|--|------------------------------------|-------|
| Right-Hand Trays | | | |
| 43988 Δ | Heavy-weight Melamine Tray | 05, 08, 25, 34, 35, 50, 59, 85, 87 | 12 ea |
| 43989 Δ | Heavy-weight Sandshades/ Rose Granite Melamine | 00*, 92 | 12 ea |
| 614R | ABS Tray | 03, 05, 09, 25, 59 | 24 ea |
| P614R | Polypropylene Tray | 05, 09, 14, 25 | 24 ea |
| Space-Saver Right-Hand Tray | | | |
| 43982 Δ | Space-Saver Melamine Tray | 05, 08, 50, 59 | 12 ea |
| 43983 Δ | Space-Saver Sandshades Melamine Tray | 92 | 12 ea |
| Left-Hand Trays | | | |
| 43980 Δ | Heavy-weight Melamine Tray | 05, 08, 25, 35, 50, 59, 85, 87 | 12 ea |
| 43981 Δ | Heavy-weight Sandshades/Rose Granite Melamine | 00*, 92, 93 | 12 ea |
| 614PC † ♦ | Polycarbonate Tray | 25 | 24 ea |
| 614 | ABS Tray | 03 | 24 ea |
| P614 | Polypropylene Tray | 05, 25 | 24 ea |
| Handled Economy Melamine Left-Hand Tray | | | |
| 5865 | Handled Economy Melamine Tray, Variegated | 00* | 12 ea |
| Space-Saver Omni-Directional Tray | | | |
| 615** | Space-Saver ABS Tray | 03, 05, 14, 25 | 24 ea |

NSF Listed products are designated with a Δ and may be prefixed with an N

*Note: Variegated(00) option is not NSF Listed

**615 is a licensed product under U.S. Patent D292,768

† 614PC carries a 5-year warranty against breakage

Rose Granite, Sandshades and Variegated items vary in color, hue and intensity from piece to piece

♦ California Residents: Bisphenol A **WARNING:** See appendix A on page 1



TRAYS, COVERS & ACCESSORIES

Polycarbonate Compartment Trays

5-Compartment Trays

- 5-year warranty against breakage
- Inside compartments have a textured surface for greater scratch resistance
- 5-year limited warranty
- NSF Listed; dishwasher safe

4-Compartment Trays

- Smaller size trays are perfect for elementary schools and lunch menus
- Omni-directional KL444 and 43986 trays feature two-way stacking
- 5-year limited warranty
- NSF Listed; dishwasher safe



Compartment Tray Cover

- Help maintain food temperatures and protect food from contamination and spills
- Dishwasher safe



Pastry Tray Covers

- Clear covers offer best visibility in bakeries, delis and convenience stores
- Sanitary covers help preserve taste and quality
- Rust-proof stainless steel hinges and screws provide long life
- Use with Carlisle trays, see pages 150-151 for corresponding trays



Carlisle Tray Guide

SC25 & SC26 fit 2618FG, 2618DFG, 2618WFG trays

SC27 & SC29 fit 1220FG, 1220DFG, 1220WFG trays

SC40 fits 1318FG, 1318DFG, 1318WFG trays

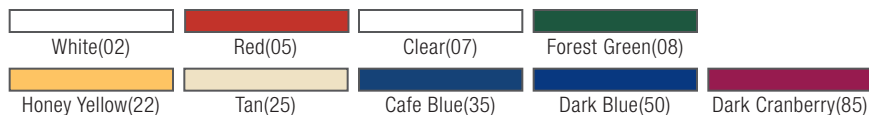

| Prod No | Description | Color | Pack |
|--|--|------------|-------|
| 5-Compartment Trays | | | |
| PCD801 ▲ | 5-Compartment Tray, 11.50/10.50/1.00 | 25 | 24 ea |
| 4-Compartment Trays | | | |
| 43984 ▲ | 4-Compartment Tray, Right-Hand, 10.11/9.79/0.51 | 05, 22, 50 | 48 ea |
| 43986 ▲ | 4-Compartment Server Tray, 10.30/9.58/0.85 | 25, 35 | 36 ea |
| KL444 ▲ | 4-Compartment Tray, 10.95/8.67/0.62 | 08, 85 | 12 ea |
| Compartment Tray Cover | | | |
| 10145 | Cover Fits Non-Handled Right and Left Handed 6-Compartment Trays | 02 | 12 ea |
| Pastry Tray Covers | | | |
| SC25 | 26" x 18" x 4" Cover | 07 | 1 ea |
| SC26 | 26" x 18" x 4" Hinged Cover | 07 | 1 ea |
| SC27 | 20" x 12" x 4" Cover | 07 | 3 ea |
| SC29 | 20" x 12" x 4" Hinged Cover | 07 | 3 ea |
| SC40 | 18" x 13" x 4" Cover | 07 | 1 ea |

NSF Listed products are designated with a ▲ and may be prefixed with an N



Room Service Trays

- 15" x 20" handled room service trays give an upscale dining experience
- Low rimmed edge and non-skid surface keep tray top items in place
- NSF Listed; dishwasher safe



RST1520NSQ

Tip Trays

- Standard Tip Tray and Check Holder are made of styrene
- Check Holders handy clip keeps checks, credit cards or cash securely in place
- NSF Listed; dishwasher safe



Money Maid™ Combo Packs

- Contains a locking coin and bill compartment, napkin holder and utility pocket; designed to clip onto trays; see our line of Griptite2, GripLite and Cork Trays shown on pages 162-163
- Combo Packs include one Money Maid and six coin trays in a shrink-wrapped set
- Round Clip-On (1401) fits all standard 14" round trays
- Rectangular Clip-On (1030) and Coin Trays fit all 12" x 16" trays



| Prod No | Description | Color | Pack |
|---------------------------------------|---|--------|-------|
| Foodservice Room Service Trays | | | |
| RST1520NSQ Δ | 15" x 20" Low Profile Room Service Tray | 03 | 6 ea |
| Tip Trays | | | |
| 3022 Δ ♦ | Standard Tip Tray; 4.5" x 6.5" | 01, 03 | 36 ea |
| 3020 Δ ♦ | Check Holder Tip Tray; 4.38" x 7.75" | 03 | 12 ea |
| Money Maid Combo Packs | | | |
| 1401 | Round Clip-On Money Maid | 01 | 12 ea |
| 1031 | Round Money Maid Combo Pack with Six Coin Trays | 01 | 12 ea |
| 1030 | Rectangular Money Maid Combo Pack with Six Coin Trays | 01 | 12 ea |

NSF Listed products are designated with a Δ and may be prefixed with an N
 ♦ California Residents: Styrene **WARNING:** See appendix C on page 1



SERVICE TRAYS

Griptite™ 2

- A service tray built for the real world
- Griptite 2 trays non-skid surface is designed to grip drinks and plates better than any existing tray
- The new surface prevents spills and is designed to look and feel like new for years
- Increased skid resistance of our GT2 surface helps bars and restaurants reduce falls and lower the cost of spilled food and drinks
- Additional coating on sides of tray reduces wear and tear due to drops
- Improved stain resistance keeps trays looking new longer
- Heavy-duty fiberglass construction eliminates warping and breakage
- Trays are stain and odor resistant
- 5-year limited warranty
- NSF Listed; dishwasher safe



1600GR2



2700GR2

1600GR2

1400GR2



| Prod No | Description | Color | Pack |
|--|---|----------|-------|
| Griptite 2 Trays | | | |
| 1100GR2 ▲ | Griptite 2 Round Tray 11.75" | 004, 076 | 12 ea |
| 1400GR2 ▲ | Griptite 2 Round Tray 14.75" | 004, 076 | 12 ea |
| 1600GR2 ▲ | Griptite 2 Round Tray 16" | 004, 076 | 12 ea |
| 1814GR2 ▲ | Griptite 2 Rectangular Tray 18" x 14.88" | 004, 076 | 12 ea |
| 1826GR2Q ▲ | Griptite 2 Rectangular Tray 18" x 25.75" | 004, 076 | 6 ea |
| 2015GR2 ▲ | Griptite 2 Rectangular Tray 20.25" x 15" | 004, 076 | 12 ea |
| 2216GR2Q ▲ | Griptite 2 Rectangular Tray 22" x 16" | 004, 076 | 6 ea |
| 2500GR2 ▲ | Griptite 2 Oval Tray 24" x 19.25" | 004, 076 | 6 ea |
| 2700GR2 ▲ | Griptite 2 Oval Tray 27" x 22.31" | 004, 076 | 6 ea |
| 3100GR2 ▲ | Griptite 2 Oval Tray 31.5" x 23.5" | 004, 076 | 6 ea |
| 3253GR2 ▲ | Griptite 2 Rectangular Tray 12.75" x 20.88" | 004 | 12 ea |

NSF Listed products are designated with a ▲ and may be prefixed with an N



GripLite® Polypropylene

- Economical alternative
- Made of a high density polypropylene co-polymer
- Molded-in, rubber liner prevents slipping and sliding of glasses and dinnerware
- A more sanitary alternative to cork trays
- Stain and odor resistant
- Handwashing is recommended



Cork Trays

- Durable plastic construction will not chip or dent
- Available in economical, lightweight, break-resistant polypropylene for bar service or break-resistant, sturdy ABS for heavy-duty use and greater stability
- The cork surface is bonded to the tray and treated to reduce wear and increase durability
- Replacement cork available at www.carlislefsp.com/replacement-parts
- Handwashing is recommended



| Prod No | Description | Color | Pack |
|-----------------------|----------------------------|----------|-------|
| GripLite Trays | | | |
| 1100GL | 11.25/0.76 Round Tray | 004, 076 | 12 ea |
| 1400GL | 14.63/0.76 Round Tray | 004, 076 | 12 ea |
| 1600GL | 16.44/0.73 Round Tray | 004, 076 | 12 ea |
| Cork Trays | | | |
| 3014 | 14.00/0.75 Round Tray | 01 | 12 ea |
| 3016 | 16.00/0.75 Round Tray | 01 | 12 ea |
| 2419 | 24.00/19.00/0.75 Oval Tray | 01 | 6 ea |
| 2823 | 28.00/23.00/0.75 Oval Tray | 01 | 6 ea |

NSF Listed products are designated with a Δ and may be prefixed with an N



SERVING TRAYS & STANDS

Celebration Trays

- Large trays are perfect for serving bread, cheeses, hors d'oeuvres and pastries
- Economically priced trays are perfect for off site catering or buffet displays
- Sturdy and reusable, they are the perfect alternative to disposables
- Chrome-plated, mirror-polished finish never requires polishing
- Hand wash only; polish dry with soft cloth

Round



Oval



Rectangular



Octagonal



| Prod No | Description | Pack |
|--------------------------|---|-------|
| Celebration Trays | | |
| 608905 | 13" Round Gadroon Tray | 12 ea |
| 608907 | 14" Round Gadroon Tray | 12 ea |
| 608919 | 20.88" x 13.5" Oval Tray with Integral Handles | 12 ea |
| 608904 | 17.75" x 12.88" Oval Tray with Ornate Border | 12 ea |
| 608913 | 17.75" x 12.88" Oval Tray with Gold Border | 12 ea |
| 608918 | 21" x 15" Rectangular Tray with Ornate Border | 12 ea |
| 608908 | 18.25" x 12.38" Rectangular Tray with Gold Border | 12 ea |
| 608909 | 20.63" x 14" Rectangular Tray with Gold Border | 12 ea |
| 608901 | 17.13" x 11.75" Octagonal Tray with Beaded Border | 12 ea |
| 608902 | 20" x 13.75" Octagonal Tray with Beaded Border | 12 ea |



Festival Trays™

- Beautiful alternative to glass, crystal, or disposables
- Use durable trays for catering, parties, weddings, conventions, cruise lines or poolside service
- Molded-in pattern gives the appearance of fine etched crystal
- Economical, break-resistant SAN resists food acids and oils
- Lowers replacement costs
- Safe in temperatures from 0° to 180°F
- Dishwasher safe



Tray Stands

- Cross supports provide superior rigidity and strength
- Durable and easy to clean
- Available in 3 forms: Steel, Wood & Plastic
- Capped legs on steel tray stands prevent slipping and marring of floors
- Extra tall steel tray stand (C3625T) reduces need for bending and stooping; additional height makes transferring heavy loads easier
- Plastic stands have sanitary, non-porous and non-corrosive finish that is easy to clean with a damp cloth

Works great with Griptite 2, GripLite and Cork Trays

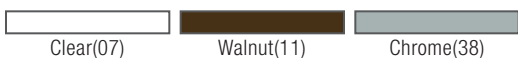

| Prod No | Description | Color | Pack |
|-----------------------|-------------------------------|-------|-------|
| Festival Trays | | | |
| 6413 | 13" Round Tray | 07 | 12 ea |
| 6416 | 16" Round Tray | 07 | 12 ea |
| 6417 | 12.5" x 7" Rectangular Tray | 07 | 12 ea |
| 6450 | 15" x 10.75" Rectangular Tray | 07 | 12 ea |
| 6426 | 22" x 16" Handled Tray | 07 | 6 ea |
| 6439 | 13" x 19.5" Handled Tray | 07 | 6 ea |
| Tray Stands | | | |
| C3625T | 36" Tall Steel Stand | 38 | 6 ea |
| C3620W | 30" Wood Stand | 11 | 6 ea |
| C3630W | 30.5" Plastic Stand | 11 | 6 ea |



CARLISLE
FOODSERVICE PRODUCTS

CARLISLE



RUGGED BEAUTIFUL PORTABLE CONVENIENT **CATERING EQUIPMENT**

Carlisle's catering equipment line is the professional's choice for your insulated transport needs. Only Carlisle Cateraide's can offer attractive contemporary styling, longer hold times and unique battle tested features that provide you superior value.





Choose The CATERAIDE™ To Best Fit Your Needs.

All Cateraides are NSF Listed and made of rugged, stain- and scratch-resistant polyethylene.

Good

LD, XT and PC Series pan carriers withstand the wear and tear of high volume catering and insulate for 4-6 hours. PC Series Cateraides are our workhorse product and include both end loaders and top loaders that can be used for hot or cold food. PC top loaders feature automatic self-venting system, preventing unsanitary vent openings and lost vent caps. LD and XT beverage carriers feature a faucet 4" from the base to ensure space for cups or glasses and include the Nylex II™ latch mounted into steel reinforcement plates for extended life. XT beverage carriers stack with standard Cateraides or other major competitors.



LD, XT & PC Series



Better

Carlisle's patented* Slide 'N Seal™ design is combined with Carlisle's thick insulation to hold temperatures for 4 to 6 hours. Slide 'N Seal carriers have self-venting, sliding doors and lids. There are no metal parts, latches, hinges or gaskets to clean, break or wear out. A beverage server is also offered in our Slide 'N Seal line. Our patented unique lid seal provides leak-proof transport. These items have a sleek, contemporary appearance. The ergonomical design them easy to load, handle, stack and store. Items include a molded-in tag slot to seal and tag carrier for safety and food identification.

*Slide 'N Seal Pan Carrier Patent No. 7,134,552



Slide 'N Seal





Best

IT Cateraides are manufactured to provide superior food quality and safety. Designed for the professional, Cateraide IT features commercial foam insulation, reinforced corner and one-handed adjustable latches. The detailed design continues with recessed hinges that stay out of the way and are less likely to catch and break. Transporting is easier with multiple comfort-grip handles and secure stacking of units. Let Cateraide IT keep your food safe and secure.



IT Series





CATERAIDE™ IT

Introducing the **newly designed** CATERAIDE IT insulated transport line of products. IT is the only choice for foodservice professionals who demand they have it all. For the first time, rugged durability and industry leading safe food holding times are combined with **attractive, contemporary styling**. CATERAIDE IT sets a **new standard for value**.

Insulated Beverage Dispenser

- Heavy foam insulation holds temperatures in the safe zone for over 6 hours
- Field adjustable latches ensure a secure seal for the life of the carrier
- “Spring Action” faucet for no drip service
- Button-hole latch design offers convenient one hand operation and keeps the doors and lids closed tightly for better temperature retention
- Sure-grip handles promote a safe, stable, two-person lift for easy loading and unloading



IT500



IT500

Easily identify contents using the integrated writing surface



Higher spigot position allows for larger cups and mugs to fit underneath with ease



| Prod No | Description | Color | Pack |
|---------------------|----------------------------|--------|------|
| CATERAIDE IT | | | |
| IT250 Δ | 2.5 gal Beverage Dispenser | 03, 43 | 1 ea |
| IT500 Δ | 5 gal Beverage Dispenser | 03, 43 | 1 ea |
| IT1000 Δ | 10 gal Beverage Dispenser | 03, 43 | 1 ea |

NSF Listed products are designated with a Δ and may be prefixed with an N
Note: IT1000 can be shipped UPS/FedEx ground at oversize cost

End & Top Loader

- Holds six 2-1/2" deep food pans
- Heavy foam insulation holds temperatures in the safe zone for over 6 hours
- Secure stacking for easy transport and storage
- Sure-grip handles promote a safe, stable, two-person lift for easy loading and unloading
- Exclusive, low-profile, double hinge opens 270° for easy loading and unloading; lies flat to save space and makes it less likely to break
- Field adjustable latches ensure a secure seal for the life of the carrier
- Door hinge can be removed for easy, thorough cleaning
- Built-in seal eliminates gaskets on end & top loaders
- Use with CaterCooler to help keep foods at ServeSafe® temps longer (shown on page 176)

ServeSafe® is a registered trademark of the National Restaurant Association



Flat top design can be used as a prep surface when space is limited



Button-hole latch design offers convenient one hand operation



Exclusive double hinge opens 270°



IT400



IT410

4 rotating wheels give this dolly unmatched maneuverability



IT140



| Prod No | Description | Color | Pack |
|---------------------|---|-------------|------|
| Cateraide IT | | | |
| IT400 Δ | End Loader (six pan capacity) | 03, 43, 62* | 1 ea |
| IT140 Δ | 4" Top Loader (holds one full size pan up to 4" deep) | 03, 43 | 1 ea |
| IT160 Δ | 6" Top Loader (holds one full size pan up to 6" deep) | 03, 43 | 1 ea |
| IT180 Δ | 8" Top Loader (holds one full size pan up to 8" deep) | 03, 43 | 1 ea |
| IT410 Δ | End Loader Dolly with Casters | 03 | 1 ea |

NSF Listed products are designated with a Δ and may be prefixed with an N

Note: IT180, IT400 can be shipped UPS/FedEx ground at oversize cos

* Color available by special order only



CATERAIDE™ SLIDE 'N SEAL

Only the Carlisle Slide 'N Seal offers **latch free construction** with no metal parts. Perfect for outdoor use in recreation and leisure markets, schools and correctional facilities.

Insulated Beverage Dispenser

- Revolutionary Slide 'N Seal design is combined with Carlisle's thick insulation to hold temperatures longer
- Patented* Slide 'N Seal design glides shut and closes tightly without latches
- No metal parts – ideal for correctional facilities
- The integrated seal keeps beverages hot or cold longer
- Sleek contemporary appearance; ergonomically designed for easy loading, handling, stacking and storing
- Tough, scratch-resistant polyethylene construction is easy to clean and maintain
- "Spring action" faucet for dripless service
- NSF Listed

*Slide 'N Seal Patents Beverage Dispensers: Patent No. 7,328,816



XB5

Find replacement parts at www.carlislefsp.com/replacement-parts



Easy twist on/off lid for leak-proof transport



Molded-in handles for easy transport



Lock can be placed through molded-in tag hole for a secure, tamper-proof closure



| Prod No | Description | Color | Pack |
|---------|--|--------------|------|
| XB5 Δ | 5 gal Slide 'N Seal Beverage Dispenser | 01*, 03, 08* | 1 ea |

NSF Listed products are designated with a Δ and may be prefixed with an N

* Color available by special order only

Top & End Loaders

- Revolutionary Slide 'N Seal design is combined with Carlisle's thick insulation to hold temperatures longer
- Patented* Slide 'N Seal lids and doors glide shut and stay closed without latches or gaskets
- No metal parts – ideal for correctional facilities
- The integrated seal keeps food hot or cold longer
- Self-venting lids and doors keep foods fresher, crisper and more appetizing
- Exclusive lid design has a molded-in tethered lock pin to seal carrier for safety
- End Loader has molded-in tag slot to seal and tag carrier for safety and food identification
- Sleek contemporary appearance; ergonomically designed for easy loading, handling, stacking and storing
- Tough, scratch-resistant polyethylene construction is easy to clean and maintain
- Use with CaterCooler to help keep foods at ServeSafe® temps longer (shown on page 176)
- NSF Listed

*Slide 'N Seal Patents

Pan Carriers: Patent No. 7,134,552



Sliding doors easily open and close for quick access and transport

Find replacement parts at
www.carlislefsp.com/replacement-parts



| Prod No | Description | Color | Pack |
|----------------------------------|-----------------------------|----------------|------|
| Slide 'N Seal Top Loaders | | | |
| XT1400 Δ | 4" Slide 'N Seal Top Loader | 03 | 1 ea |
| XT1600 Δ | 6" Slide 'N Seal Top Loader | 01**, 03, 08** | 1 ea |
| XT1800 Δ | 8" Slide 'N Seal Top Loader | 01**, 03 | 1 ea |
| Slide 'N Seal End Loaders | | | |
| XT3000R Δ | Slide 'N Seal End Loader | 01*, 03 | 1 ea |

NSF Listed products are designated with a Δ and may be prefixed with an N
 NOTE: XT1800, XT3000R can be shipped UPS/FedEx Ground at oversize cost

** Color available by special order only



CATERAIDE™ XT & LD

XT Series Insulated Beverage Dispenser - *The Value Leader*

- Made of rugged, stain- and scratch-resistant polyethylene
- Filled with extra thick foam insulation for maximum temperature retention
- Stacks with itself and with other major competitors
- Smooth interior walls and rounded corners leave no food traps and provides quick clean-up
- Convex lid design prevents leaks during use as pressure increases
- Modern XT lid design with convenient pop-up vent
- Improved O-ring seal eliminates leaks during transport
- Easy-grip, formed handles for transporting
- Sure-Latch™ wide design has three times the latch area of other beverage servers for a secure seal
- Latches are mounted into steel reinforcement plates for long life
- “Spring action” faucet for dripless service
- NSF Listed



Find replacement parts at www.carlislefsp.com/replacement-parts



| Prod No | Description | Color | Pack |
|--------------------------------------|-------------------------|------------------|------|
| Cateraide XT Beverage Servers | | | |
| XT2500 Δ | 2.5 gal Beverage Server | 01, 03, 08*, 59 | 1 ea |
| XT5000 Δ | 5 gal Beverage Server | 01, 03, 08, 59 | 1 ea |
| XT10000 Δ | 10 gal Beverage Server | 01, 03, 08*, 59* | 1 ea |

NSF Listed products are designated with a Δ and may be prefixed with an N

NOTE: XT10000 can be shipped UPS/FedEx Ground at oversize cost

* Color available by special order only

LD Series Insulated Beverage Dispensers

- Made of rugged, stain- and scratch-resistant polyethylene
- Filled with extra thick foam insulation for maximum temperature retention
- Stacks with itself and with other major competitors
- Smooth interior walls and rounded corners leave no food traps and provides quick clean-up
- Convex lid design prevents leaks during use as pressure increases
- Reinforced, tight-fitting lids with O-ring seals prevent leaks and provide increased heat retention
- Easy-grip, formed handles for transporting
- “Spring action” faucet for dripless service
- Nylex II™ latches have no sharp edges, won't rust, bend or dent like metal and are mounted into steel reinforcement plates for long life
- NSF Listed



Find replacement parts at
www.carlislefsp.com/replacement-parts



| Prod No | Description | Color | Pack |
|--------------------------------------|-------------------------|------------------|------|
| Cateraide LD Beverage Servers | | | |
| LD250N Δ | 2.5 gal Beverage Server | 01, 03 | 1 ea |
| LD500N Δ | 5 gal Beverage Server | 01, 03, 08*, 59 | 1 ea |
| LD1000N Δ | 10 gal Beverage Server | 01, 03, 08*, 59* | 1 ea |

NSF Listed products are designated with a Δ and may be prefixed with an N

NOTE: LD1000N can be shipped UPS/FedEx Ground at oversize cost

* Color available by special order only



CATERAIDE™

CaterCooler™

- Freeze CaterCooler overnight or for eight hours and it will keep food at or below the ServSafe® guidelines of 40°F for up to eight hours without ice*
- Designed to slide into a Cateraide End Loader, Double End Loader or place on top of food pans in a Top Loader
- Durable polyethylene shell

ServSafe® is a registered trademark of the National Restaurant Association

*Temperature retention is based on CaterCooler being pre-frozen for a minimum of eight hours, then placed directly into Cateraide pan carrier. Pan Carrier unit is then filled with pre-chilled food pans. Testing was conducted under ambient room temperatures of 76°F.

CaterCooler shown with PC300N End Loader



PC660



Pan Carriers

- Cateraide construction made of rugged, stain- and scratch-resistant polyethylene
- Filled with extra thick foam insulation for maximum temperature retention
- Exclusive automatic self-venting system eliminates unsanitary vent openings and easily lost vent caps
- Heat resistant to 200°F
- Find replacement parts at www.carlislefsp.com/replacement-parts
- NSF Listed

Use with StorPlus™ Food Pans or DuraPan™ shown on pages 218-225



PC300N

PC600N

Insulated End Loader

- Individual track for each food pan
- PC300N end loader holds five 2.5" deep pans
- PC600N has twice the capacity of the PC300N
- PC600N's separate compartments enable you to put hot food in one; cold in the other
- Use with CaterCooler (shown above) to help keep foods at ServeSafe® temps longer
- NSF Listed



| Prod No | Description | Color | Pack |
|--|-------------------|--------------------|------|
| CaterCooler | | | |
| PC660 | CaterCooler | 14 | 1 ea |
| Cateraide Insulated End Loaders | | | |
| PC300N Δ | End Loader | 01, 03, 08, 59, 95 | 1 ea |
| PC600N Δ | Double End Loader | 01, 03, 08, 59* | 1 ea |

NSF Listed products are designated with a Δ and may be prefixed with an N

NOTE: LD500NSS can be shipped UPS/FedEx Ground at oversize cost

* Color available by special order only



Insulated Sheet Pan & Tray Carrier

- Individual tracks accommodate seven 18" x 26" trays
- Use with sheet pans shown on page 191
- NSF Listed



TC1826N



Insulated Top Loaders

- Accommodates all third, half and full size food pans
- PC188N top loader holds up to 8" deep food pan
- NSF Listed



PC180N

PC160N

PC188N

PC140N



Insulated Soup & Chili Servers - *Ideal for Food Festivals & Outdoor Venues*

- Same high-quality features and construction as our standard Cateraides
- Perfect for transporting and serving soup and chili
- Stacks with 2.5 gallon & 5 gallon beverage servers
- There are no faucets
- NSF Listed



LD350N

LD500NSS



Brown(01)

Black(03)

| Prod No | Description | Color | Pack |
|---|-----------------------------------|---------|------|
| Cateraide Insulated Sheet Pan & Tray Carrier | | | |
| TC1826N Δ | Sheet Pan, Tray Carrier | 01, 03 | 1 ea |
| Cateraide Insulated Top Loaders | | | |
| PC140N Δ | 12 qt, 4" Single Pan Carrier | 01, 03* | 1 ea |
| PC160N Δ | 18 qt, 6" Single Pan Carrier | 01, 03 | 1 ea |
| PC180N Δ | 24 qt, 8" Combination Pan Carrier | 01, 03* | 1 ea |
| Cateraide Insulated Soup & Chili Servers | | | |
| LD350N Δ | 3.5 gal Soup & Chili Server | 01, 03 | 1 ea |
| LD500NSS Δ | 5 gal Soup & Chili Server | 01, 03 | 1 ea |

NSF Listed products are designated with a Δ and may be prefixed with an N

* Color available by special order only



CATERAIDE™

Dollies - *Industry Leader*

Polyethylene Dollies

- 4" heavy-duty, quiet and non-marking swivel casters
- Rolls easily on carpeted floors
- DL300R holds up to two Cateraide End Loaders (PC300N) or any Cateraide Top Loader
- XDL3000 holds up to two Slide 'N Seal End Loaders (XT3000R) when stacked
- NSF Listed



DL300R

XDL3000H



Aluminum Dollies

- Made of sturdy, light-weight, no-rust aluminum
- Plastic coated corner bumpers protect against marring furnishings
- 4" heavy-duty, quiet and non-marking swivel casters
- Rolls easily on carpeted floors
- DL300 holds up to two stacked Cateraide End Loaders
- DL1826 holds up to three stacked Sheet Pan Carriers



DL1826

DL300



Use Carlisle Utility Carts on page 318 to transport Cateraides



PC300 with DL300R



| Prod No | Description | Color | Pack |
|---------------------------------------|-----------------------------------|-------|------|
| Polyethylene Cateraide Dollies | | | |
| XDL3000H Δ | 22.38" x 28.75" Dolly with Handle | 03 | 1 ea |
| DL300R Δ | 20.38" x 26.75" Dolly | 03 | 1 ea |
| Aluminum Cateraide Dollies | | | |
| DL300 | 23.25" x 16.88" Dolly | 23 | 1 ea |
| DL1826 | 28.63" x 22" Dolly | 23 | 1 ea |

NSF Listed products are designated with a Δ and may be prefixed with an N
NOTE: Cateraide Universal Dolly is not UPS/FedEx Ground shippable



Insulated Ice Caddies

- Cateraide construction made of rugged, stain- and scratch-resistant polyethylene
- Filled with extra thick foam insulation for maximum temperature retention
- Rounded inside corners and removable lid for thorough cleaning
- Stainless steel, reinforced hinges prevent rusting
- Easy rolling, heavy-duty 5" casters
- Find replacement parts at www.carlislefsp.com/replacement-parts

200 Lb Caddy

- Lid opens and lays flat against side of unit to conserve space
- Front faucet for fast drainage and easy cleanup; inside has sloped base for complete drainage
- Includes convenient shelf; allows water to drain away from ice
- Dual handles for easy maneuverability
- 10" non-marking back wheels roll easily over rough surfaces



IC2220

125 Lb Caddies

- Nylex™ latches eliminate sharp edges; won't rust, bend or dent
- Ice Caddies IC2250 and IC2254 are only 28.75" high for smaller, more compact space requirements
- IC2250T Ice Caddy is 36.5" high to reduce back bending motion
- IC2250T Ice Caddy has 8" non-marking back wheels for easy maneuvering over rough surfaces
- NSF Listed



IC2250T



IC2254



| Prod No | Description | Color | Pack |
|------------------------------|--|-------------------|------|
| Cateraide Ice Caddies | | | |
| IC2220 | 200 lb Ice Caddy with Ice Caddy Shelf; 10" Wheels, 2 Swivel Casters (one with brake) | 01*, 03, 08*, 59* | 1 ea |
| IC2250 Δ | 125 lb Ice Caddy; 2 Rigid Casters, 2 Swivel Casters (one with brake) | 01*, 03 | 1 ea |
| IC2254 Δ | 125 lb Ice Caddy; 4 Swivel Casters (one with brake) | 01*, 03 | 1 ea |
| IC2250T Δ | 125 lb Tall Ice Caddy; 8" Wheels, 2 Swivel Casters (one with brake) | 03 | 1 ea |

NSF Listed products are designated with a Δ and may be prefixed with an N

Note: Ice Caddies cannot ship UPS/FedEx Ground

* Color available by special order only



Mrs. Kari

FRANCISTUTTLE
TECHNOLOGY CENTER

CARLISLE
FOODSERVICE PRODUCTS

QUALITY
DURABLE
STRONG
**PROFESSIONAL
COOKWARE**

Carlisle cookware and bakeware are designed to support professional chefs, helping them to succeed in their constant pursuit to delight their guests with great food. Our wide selection of top-quality products delivers reliable, long-lasting value to your operation.





FRY PANS

Excalibur Fry Pans feature a **stainless steel reinforced, non-stick layer** to protect from daily wear and tear. The coating is micro-bonded to the pan creating a multi-layer surface that **effortlessly releases food** and resists scratching better than traditional non-stick surfaces.

Excalibur® Fry Pans

- Scratch-resistant surface resists wear and tear from metal utensils better than any other coating
- Non-stick surface cooks evenly without requiring added fat or oil to release food
- Hardened 3004 Aluminum Alloy body resists denting and maintains shape
- Triple rivet handle stands up to daily use within today's industrial kitchens
- Removable Dura-Kool sleeve keeps handle cool to the touch
- NSF Listed; dishwasher safe



60910XRS
60912XRS
60914XRS

60908XRS

60907XRS

Use with High Heat Turner shown on page 213

Teflon Select® Fry Pan

- Scratch-resistant surface is 75% more resistant to scratches than regular Teflon
- Non-stick surface cooks evenly without requiring added fat or oil to release food; ideal for pancakes and omelet stations
- Triple rivet handle stands up to daily use within today's industrial kitchens
- Removable Dura-Kool sleeve keeps handle cool to the touch
- Hardened 3004 Aluminum Alloy resists denting and maintains shape
- NSF Listed; dishwasher safe



60910SERS
60912SERS
60914SERS

60908SERS

60907SERS

| Prod No | Description | Cover | Pack |
|-------------------------------|---------------------------|--------|-------|
| Excalibur Fry Pans | | | |
| 60907XRS | 7" Excalibur Fry Pan | 60907C | 12 ea |
| 60908XRS | 8" Excalibur Fry Pan | 60908C | 12 ea |
| 60910XRS | 10" Excalibur Fry Pan | 60910C | 6 ea |
| 60912XRS | 12" Excalibur Fry Pan | 60912C | 6 ea |
| 60914XRS | 14" Excalibur Fry Pan | 60914C | 3 ea |
| Teflon Select Fry Pans | | | |
| 60907SERS | 7" Teflon Select Fry Pan | 60907C | 12 ea |
| 60908SERS | 8" Teflon Select Fry Pan | 60908C | 12 ea |
| 60910SERS | 10" Teflon Select Fry Pan | 60910C | 6 ea |
| 60912SERS | 12" Teflon Select Fry Pan | 60912C | 6 ea |
| 60914SERS | 14" Teflon Select Fry Pan | 60914C | 3 ea |

NSF Listed products are designated with a and may be prefixed with an N
Teflon® is a registered trademark of E.I. DuPont® DeNemours & Co., Inc.
Excalibur® is a registered trademark of Whitford B. U. Corp.



Covers sold separately on page 186
Recommended covers listed in the product charts

Traditional Aluminum Fry Pans

- Hard 3004 aluminum body stands up to the toughest foodservice environment
- Gently sloped sides are ideal for turning, flipping and removing foods
- Aluminum provides excellent heat transfer
- NSF Listed



SSAL™ Fry Pans

- Finest 18-8 stainless interior is permanently bonded to hard aluminum body to create the ultimate fry pan for any foodservice environment
- Aluminum body ensures maximum heat transfer throughout the pan and eliminates hot spots and scorching
- Easy care stainless interior is incredibly durable and will not react with food or discolor sauces
- Special rivet design securely attaches handle to pan; bond will not loosen like traditional rivets
- NSF Listed



| Prod No | Description | Cover | Pack |
|--------------------------------------|----------------------|--------|-------|
| Traditional Aluminum Fry Pans | | | |
| 60907RS | 7" Aluminum Fry Pan | 60907C | 12 ea |
| 60908RS | 8" Aluminum Fry Pan | 60908C | 12 ea |
| 60910RS | 10" Aluminum Fry Pan | 60910C | 6 ea |
| 60912RS | 12" Aluminum Fry Pan | 60912C | 6 ea |
| 60914RS | 14" Aluminum Fry Pan | 60914C | 3 ea |
| SSAL Fry Pans | | | |
| 60708RS | 8" SSAL Fry Pan | 60908C | 12 ea |
| 60710RS | 10" SSAL Fry Pan | 60910C | 6 ea |
| 60712RS | 12" SSAL Fry Pan | 60912C | 6 ea |

NSF Listed products are designated with a and may be prefixed with an N



COOKWARE

Standard Weight Aluminum Cookware

Standard Weight Aluminum Cookware is made from 3003 alloy that allows cookware to heat rapidly and retain even heat. A double thick top edge and base offer superior strength and shape retention. All Standard Weight Aluminum Cookware is NSF Listed.



Stock Pots

- Perfect for preparing soups, pastas or long-simmering stocks and sauces
- Can also be used with our stainless steel baskets for steaming, boiling or deep frying

Braziers

- Brazier's wide surface is perfect for browning meats and simmering stews
- Heavy plated loop handles for easy transport
- Optional covers maintain moist heat for slow cooking



Covers sold separately on page 186
Recommended covers listed in the product charts

| Prod No | Description | Cover | Pack |
|-----------------------------------|---------------------------------|--------|------|
| Standard Weight Stock Pots | | | |
| 61210 | 10 qt Standard Weight Stock Pot | 61210C | 1 ea |
| 61212 | 12 qt Standard Weight Stock Pot | 61210C | 1 ea |
| 61216 | 16 qt Standard Weight Stock Pot | 61216C | 1 ea |
| 61220 | 20 qt Standard Weight Stock Pot | 61220C | 1 ea |
| 61224 | 24 qt Standard Weight Stock Pot | 61224C | 1 ea |
| 61232 | 32 qt Standard Weight Stock Pot | 61232C | 1 ea |
| 61240 | 40 qt Standard Weight Stock Pot | 61240C | 1 ea |
| 61260 | 60 qt Standard Weight Stock Pot | 61260C | 1 ea |
| Standard Weight Braziers | | | |
| 61115 | 15 qt Standard Weight Brazier | 61232C | 1 ea |
| 61120 | 20 qt Standard Weight Brazier | 61120C | 1 ea |
| 61125 | 25 qt Standard Weight Brazier | 61125C | 1 ea |
| 61130 | 30 qt Standard Weight Brazier | 61130C | 1 ea |

NSF Listed products are designated with a and may be prefixed with an N



Tapered Aluminum Sauce Pans

- Tapered shape reduces contact with direct heat source and encourages cooking by diffusing heat from the side walls
- Sides are gently sloped and corners are rounded for easy stirring
- Tapered design nests for convenient storage
- Extra wide lip adds durability and offers more precise pouring
- 8.5 & 10 qt saucepan have side handle to aid lifting



Sectional Pasta Cookers

- Ideal for pasta, vegetables and seafood
- Save time, energy and space by cooking multiple portions in one pot
- Stainless steel inserts with .13" holes feature cool-touch handles and can be hooked on the side of the pot for easy draining
- Complete unit includes 20 qt pot and 4 quarter size inserts

Double Boiler

- Heavy-duty construction and extra thick base for superior thermal conductivity; prevents scorching of delicate sauces, chocolate and more
- Traditional weight, satin finish cookware
- Durable rolled edge with sanitary open bead
- Double boiler includes stock pot, insert and cover; inserts are also available separately
- NSF Listed



| Prod No | Description | Cover | Pack |
|---|---|--------|------|
| Standard Weight Tapered Sauce Pans | | | |
| 61702 | 2.5 qt Tapered Sauce Pan | 61702C | 6 ea |
| 61704 | 4.5 qt Tapered Sauce Pan | 61704C | 6 ea |
| 61707 | 6 qt Tapered Sauce Pan | 61707C | 6 ea |
| 61708 | 8.5 qt Tapered Sauce Pan | 61708C | 6 ea |
| 61710 | 10 qt Tapered Sauce Pan | 61710C | 6 ea |
| Sectional Pasta Cooker | | | |
| 60100PC | Quarter Size Sectional Pasta Cooker includes 20 qt pot with 4 inserts | — | 1 ea |
| 60102 | 20 qt Pot for Pasta Cooker Combination | — | 2 ea |
| 60101 | Quarter Size Perforated Insert | — | 4 ea |
| Double Boilers | | | |
| 60921 | 12 qt Double Boiler with 12 qt Insert | — | 1 ea |
| 60934 | 20 qt Double Boiler with 16 qt Insert | — | 1 ea |

NSF Listed products are designated with a and may be prefixed with an N



COOKWARE

Heavy-Duty Covers

- Carlisle's unique reinforced design resists dents and holds its shape better than old-fashioned lids
- Extra heavy-duty covers are fabricated from hard 3004 aluminum to stand up to the toughest foodservice environment
- Open looped handles are securely riveted
- NSF Listed



Domed Fry Pan Covers

- Domed covers fit snugly on the pans creating a self-basting effect by allowing moisture to condense and return to the pan
- Strong welds on handle ensure long life
- NSF Listed



| Prod No | Description | Pack |
|-----------------------------|-------------------------|------|
| Heavy-Duty Covers | | |
| 61120C | Cover for 61120 | 6 ea |
| 61125C | Cover for 61225 | 6 ea |
| 61130C | Cover for 61130 | 6 ea |
| 61210C | Cover for 61210 & 61212 | 6 ea |
| 61216C | Cover for 61216 | 6 ea |
| 61220C | Cover for 61220 | 6 ea |
| 61224C | Cover for 61224 | 6 ea |
| 61232C | Cover for 61232 & 61115 | 6 ea |
| 61240C | Cover for 61240 | 6 ea |
| 61260C | Cover for 61260 | 6 ea |
| 61702C | Cover for 61702 | 6 ea |
| 61704C | Cover for 61704 | 6 ea |
| 61707C | Cover for 61707 | 6 ea |
| 61708C | Cover for 61708 | 6 ea |
| 61710C | Cover for 61710 | 6 ea |
| Domed Fry Pan Covers | | |
| 60907C | 7" Dome Fry Pan Cover | 6 ea |
| 60908C | 8" Dome Fry Pan Cover | 6 ea |
| 60910C | 10" Dome Fry Pan Cover | 6 ea |
| 60912C | 12" Dome Fry Pan Cover | 6 ea |
| 60914C | 14" Dome Fry Pan Cover | 3 ea |

NSF Listed products are designated with a and may be prefixed with an N



Mesh Baskets

Nickel Plated

- Perfect for cooking or reheating single servings of pasta
- Baskets can also be used for small batch frying or breading
- Stainless baskets feature cool-touch handles and heavy-duty chrome steel hook for draining basket

Chrome Plated

- Chrome plated carbon steel basket is designed for small batch deep frying
- Chrome plated carbon basket not intended for use in water



Burger Cover

- Accelerates cooking on grill tops
- Aluminum cover provides quick and even heating for thorough cooking
- Helps retain flavor and moisture
- Heat resistant knob is cool to the touch



| Prod No | Description | Pack |
|--|--------------------|-------|
| Nickel Plated Mesh Baskets | | |
| 601028 | 8.75" Fryer Basket | 12 ea |
| 601029 | 9.75" Fryer Basket | 12 ea |
| 601031 | 11.5" Fryer Basket | 12 ea |
| Chrome Plated Carbon Steel Mesh Baskets | | |
| 601000 | 8.75" Fryer Basket | 12 ea |
| 601001 | 9.75" Fryer Basket | 12 ea |
| 601002 | 11.5" Fryer Basket | 12 ea |
| 601003 | 13.5" Fryer Basket | 12 ea |
| Burger Cover | | |
| 60103 | 6" Burger Cover | 12 ea |

NSF Listed products are designated with a and may be prefixed with an N



BAKEWARE

Roast & Bake Pans

- Extra large, heavy-duty sizes capable of holding multiple roasts, hams or turkeys
- Reinforced rolled edge for added strength
- 60306, 601923 have securely riveted drop handles for easier and safer lifting of heavy loads
- NSF Listed



601922



60306



601923

| Prod No | Description | Pack |
|------------------------------|---|------|
| Roast & Bake Pans | | |
| 60306 | 21 ga, 8 qt Bake Pan with Drop Handles; 17" x 11" x 2.5" | 6 ea |
| 601922 | 17 ga, 13.5 qt Bake Pan; 26" x 18" x 2.25" | 6 ea |
| 601923 | 17 ga, 19 qt Bake Pan with Drop Handles; 26" x 18" x 3.5" | 4 ea |

NSF Listed products are designated with a and may be prefixed with an N



Commercial Weight Double Roasters

- Commercial weight aluminum roasters are equipped with 2 steel reinforced bands for extra heavy usage
- Pans feature seamless drawn sanitary open bead
- Covers and bases can also be used individually as open roasters
- Full size pans fit standard baker's racks
- Drop handles are securely riveted
- 60345's fabricated lugs hold top securely in place
- NSF Listed



| Prod No | Description | Pack |
|--|---|------|
| Commercial Weight Double Roasters | | |
| 60346 | Double Roaster; 24" x 18" x 9" (includes 60344 & 60345) | 1 ea |
| 60344 | 16 ga, 26 qt Roast Pan (use as cover); 24" x 18" x 4.5" | 2 ea |
| 60345 | 16 ga, 26 qt Roast Pan (use as base); 24" x 18" x 4.5" | 2 ea |

NSF Listed products are designated with a and may be prefixed with an N



BAKEWARE

Aluminized Steel Pans

Heavy-Duty Muffin Pan

- Heavy-duty muffin pan has seamless cups locked into heavy aluminum frame
- Holds up in busy foodservice environments



602424

Baking Pans

- Aluminized steel pans are the ultimate choice for baking breads, cupcakes, muffins and cakes
- The special finish provides greater heat transfer for lower baking temperatures, shorter baking time and better looking, more uniform baked goods
- Corrosion-resistant material withstands temperatures in excess of 700°F
- Individual seamless cups are locked into heavy frames



601837
601834
601840
601829

Bread Pans & Pullman Pans

- Aluminized steel pans are the ultimate choice for baking breads and cakes



604144

604174



606903

606902

| Prod No | Description | Pack |
|-------------------------------------|--|-------|
| Aluminized Steel Baking Pans | | |
| 601829 | 24 Cup/1.75 oz Mini-Muffin/Cupcake Pan* | 6 ea |
| 601830 | 12 Cup/3.5 oz Heavy-Duty Cupcake Pan | 12 ea |
| 601840 | 24 Cup/3.5 oz Heavy-Duty Cupcake Pan | 6 ea |
| 601834 | 12 Cup/4 oz Large Cup Cupcake Pan | 6 ea |
| 601837 | 12 Cup/6 oz Extra Large Cup Cupcake Pan | 6 ea |
| 606902 | 6 Loaf Mini Loaf Pan (Loaf Size: 4" x 2.5" x 2.25") | 6 ea |
| 606903 | 12 Loaf Mini Loaf Pan (Loaf Size: 4" x 2.5" x 1.38") | 6 ea |
| Aluminized Steel Bread Pans | | |
| 604144 | 1 lb Loaf Bread Pan, 9.5" x 5" x 2.77" | 12 ea |
| 604174 | 1.75 lb Loaf Bread Pan, 12.8" x 5" x 2.8" | 12 ea |
| Heavy-Duty Muffin Pan | | |
| 602424 | 24 Cup/3 oz Aluminum Muffin Pan* | 12 ea |

*Handwashing recommended



Bun Pans & Sheet Pans

- Sturdy bun pans for baking, transporting and displaying cookies, bread and pastries
- Aluminum surface allows even browning of foods
- Manufactured from extra hard, tempered aluminum alloy with galvanized steel wire reinforced bead
- Tapered shape stacks for storage
- Use with Icing Grates listed below



Icing Grates

- Use grates for thawing foods or cooling and icing cakes, cookies and desserts
- 601306 welded icing grate fits full size bun pans and is made of nickel plated steel
- 601642, 601647 mesh icing grates are made of heavy, steel mesh wire



| Prod No | Description | Pack |
|----------------------------------|--|-------|
| Bun Pans & Sheet Pans | | |
| 601825 | 18 ga, Full Size Sheet Pan; 25.75" x 17.81" x 1.13" | 12 ea |
| 601826 | 16 ga, Heavy-Duty Full Size Sheet Pan; 25.75" x 17.81" x 1.13" | 12 ea |
| 601824 | 18 ga, Half Size Bun Pan; 17.81" x 12.88" x 1" | 12 ea |
| 601828 | 18 ga, Perforated Full Size Sheet Pan; 25.75" x 17.81" x 1.13" | 12 ea |
| Icing Grates | | |
| 601306 | Icing Grate, Fits 601825, 601826, 601828 Bun Pan | 12 ea |
| 601642 | Mesh Icing Grate, Fits 601824 Bun Pan | 12 ea |
| 601647 | Mesh Icing Grate, Fits 601825, 601826, 601828 Bun Pan | 12 ea |



CARLISLE
FOODSERVICE PRODUCTS

QUALITY
EFFICIENT
DURABLE
INNOVATIVE
**KITCHEN
ACCESSORIES**

Designed and used by chefs, Carlisle kitchen accessories are created to improve food safety, promote quality, save labor and reduce waste. For efficient kitchen operations day after day you can count on Carlisle to help make work easier.





ALLERGEN CONTROL PRODUCTS

In a kitchen, the **most dangerous allergen** is the one that isn't identified. Carlisle **Allergen Control Products** help your employees segregate their allergen sensitive orders ensuring a safer dining experience for your customers.

The Big 8

The big 8 are the principal allergenic foods that account for nearly 90% of all food allergies in the United States

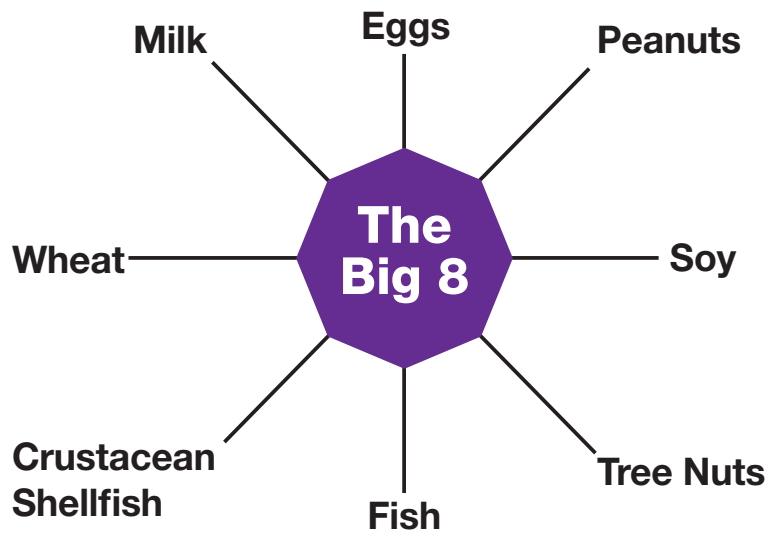

Symptoms of an Allergic Reaction

| | | |
|---------------------------------------|--------------------------------|----------------------|
| Nausea | Wheezing / Shortness of Breath | Hives / Itchy Rashes |
| Swelling of Face, Eyes, Hands or Feet | Vomiting / Diarrhea | Abdominal Pain |



Capacity indicators allow measuring, prepping and portioning in a single container for added versatility, efficiency and inventory control



StorPlus Square Container
Pages 228-229

Bold purple markings make these measuring cups easy to read



Commercial Measuring Cup
Page 204

Carlisle offers purple Measure Misers in a variety of sizes with the capacity molded into the handle for portion control



Measure Misers
Page 207

Purple tote boxes are perfect for ensuring that cross-contamination doesn't happen during the cleaning process



Comfort Curve Tote Boxes
Page 252

Purple Bronco Waste Containers are NSF Listed for food contact and cleanability—perfect for food storage



Bronco Waste Containers
Pages 324-325



HEAT LAMPS

Heat Lamps

- Wide selection of heat lamps for both front-of-the-house buffet service and back-of-the-house temperature retention
- 1-year limited warranty

Flexiglow™

- Spun aluminum shade with flared rim for added strength
- Shade is drilled for increased heat dissipation
- Optional NSF Listed maple cutting board and drip pan is perfect for a front-of-the-house carving station
- Meets standard electrical specifications shown on page 197
- Rated UL recognized

Dual Arm Flexiglow

- Two flex arms provide heating for separate products
- Vinyl-coated arms help keep unit sanitary
- Includes two 250-watt Red bulbs

Single Arm Flexiglow

- Switch located away from the heat source
- Includes 250 watt Red bulb



HL8285GB



HL8195B



HL8185



HLA20



HL8285

Two Bulb Adjustable

- Adjustable arm for different heat settings
- Spun aluminum shades with flared rim for added strength and more even heat dissipation
- Ceramic insulated sockets with nickel plated contacts to prevent fusing
- Meets Standard Electrical Specifications shown on below
- On/Off switch mounted on arm away from heat zone
- Includes two 250-watt Clear bulbs
- UL & CSA listed



Standard Electrical Specifications

- Sockets are ceramic insulated and furnished with a nickel-plated copper screw shell and contact point to prevent fusing
- Internal wiring is braided and silicone covered and rated 200°C
- Durable 16 gauge external wiring with molded three-prong plug
- All switches are either “T” or “L” rated and surpass minimum requirements
- All switches are located out of the heat zone
- Designed to operate on 110-120 volt AC service; wiring will accommodate 250 volt AC service
- Heat lamps have one year warranty against defects in materials and workmanship

Find replacement parts at
www.carlislefsp.com/replacement-parts



| Prod No | Description | Color | Pack |
|--------------------------------------|--|-------|------|
| Flexiglow Heat Lamps | | | |
| HL8285 Δ | Dual Arm Flexiglow, Aluminum, 24" Arm | 00 | 1 ea |
| HL8285G Δ | Dual Arm Flexiglow, Gold, 24" Arm | 21 | 1 ea |
| HL8285B** Δ | Dual Arm Flexiglow with Board & Pan, Aluminum, 24" Arm | 00 | 1 ea |
| HL8285GB** Δ | Dual Arm Flexiglow with Board & Pan, Gold, 24" Arm | 21 | 1 ea |
| HL8185 Δ | Flexiglow, Aluminum, 24" Arm | 00 | 1 ea |
| HL8185G Δ | Flexiglow, Gold, 24" Arm | 00* | 1 ea |
| HL8185C | Flexiglow, Aluminum, 24" Arm, Includes Clamp | 00 | 1 ea |
| HL8185GC | Flexiglow, Gold, 24" Arm, Includes Clamp | 00* | 1 ea |
| HL8185B** Δ | Flexiglow with Board & Pan, Aluminum, 24" Arm | 00 | 1 ea |
| HL8185GB** Δ | Flexiglow with Board & Pan, Gold, 24" Arm | 21 | 1 ea |
| HLA20 | Flexiglow Clamp (8100 & 8200 Series) | 00* | 1 ea |
| HL8195 Δ | Flexiglow Aluminum, 39" Arm | 00 | 1 ea |
| HL8195B** Δ | Flexiglow with Board, Aluminum, 39" Arm | 00 | 1 ea |
| Two Bulb Adjustable Heat Lamp | | | |
| HL7237 Δ | Two Bulb Free Standing Adjustable Heat Lamp | 00 | 1 ea |
| HL7237PS | Two Bulb Free Standing Adjustable Heat Lamp with 13" x 21" SS Pan & Screen | 00 | 1 ea |

NSF Listed products are designated with a Δ and may be prefixed with an N

**Includes 18" x 26" drip pan and 16" x 24" maple cutting board

Note: To allow for choice of lamp placement, holes in board are not pre-drilled

Note: HL8185B, HL8185GB, HL8195, HL8195B, HL8285, HL8285G, HL8285B, HL8285GB can be shipped UPS/FedEx Ground at oversize cost

Note: Heat Lamps sold or shipped outside the U.S. do not include a plug or bulb(s)



ORDER WHEELS AND RACKS

Order Wheels

- Keeps orders in clear view during preparation
- Rugged stainless steel construction
- Unique ball/spring clips for easy, one-handed check placement
- Custom length (381EX) extensions available for counter and ceiling mount models

Counter Mount Model

- Wheel mounts to any counter
- 9" extension & plate included

Ceiling Hung Model

- Square "CH" plate on top of axle mounts to ceiling with 4 screws

Note: Ceiling hung model does not include an extension. Extender must be purchased separately

Wall Mounted Model

- Wheel mounts to any wall
- Extension & plate included

Pedestal Model

- Heavy chrome 10" round base won't tip
- Rubber footprint prevents slipping and protects counter tops
- Includes 9" extension for adjustable height



3816MP



3812CH



3812CM



3816WH

Find replacement parts at
www.carlislefsp.com/replacement-parts

Slide Order Racks

- Ball-bearing action provides clean look & one-handed sliding action
- Choose from rugged stainless steel or economical aluminum options
- Custom lengths are available by special order



38240A

38360

| Prod No | Description | Pack |
|--------------------------|---|------|
| Order Wheels | | |
| 3812MP | 12 Clip, 14" Portable Order Wheel | 1 ea |
| 3816MP | 16 Clip, 18" Portable Order Wheel | 1 ea |
| 3820MP | 20 Clip, 23" Portable Order Wheel | 1 ea |
| 3812CM | 12 Clip, 14" Counter Mount Order Wheel | 1 ea |
| 3812CH | 12 Clip, 14" Ceiling Hung Order Wheel | 1 ea |
| 3816CH | 16 Clip, 18" Ceiling Hung Order Wheel | 1 ea |
| 3820CH | 20 Clip, 23" Ceiling Hung Order Wheel | 1 ea |
| 3816WH | 16 Clip, 18" Wall Mounted Order Wheel with 9" Extension | 1 ea |
| Slide Order Racks | | |
| 38360 | 36" Stainless Steel Slide Order Rack | 3 ea |
| 38480 | 48" Stainless Steel Slide Order Rack | 3 ea |
| 38180A | 18" Aluminum Slide Order Rack | 3 ea |
| 38240A | 24" Aluminum Slide Order Rack | 3 ea |
| 38360A | 36" Aluminum Slide Order Rack | 3 ea |
| 38480A | 48" Aluminum Slide Order Rack | 3 ea |

Ice Only Container

- Safely and easily transports small loads of ice
- Perfect for filling food bars or other iced food displays, ice bins on portable bars or even automatic ice dispensers at self-serve beverage stations
- Heavy-duty construction and ergonomic Comfort Curve™ handles provide easy handling; deep hand holds on base for controlled tipping
- Lids are reinforced and have snap down tab lock
- Imprinted on two sides in both English & Spanish
- NSF Listed



Scoops

- Great economical choice for your front and back of house ice handling needs.

Metal Scoops

- Heavy-duty scoops have easy to hold pistol-grip handles with clearly marked capacities



Polycarbonate Scoops

- Easy-grip plastic handle doesn't transfer cold
- Features a hole for hanging or tying to a container
- Durable polycarbonate material
- NSF Listed; dishwasher safe

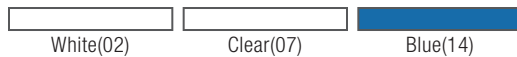

| Prod No | Description | Color | Pack |
|-------------------------------------|---------------------------------|-------|-------|
| Ice Only Container & Lid | | | |
| 341010ICE Δ | 10 gal Ice Only Container | 02 | 6 ea |
| 341011 | 10 gal Ice Only Container Lid | 02 | 6 ea |
| Scoops | | | |
| 606040 | 38 oz Solid Cast Aluminum Scoop | — | 12 ea |
| 606055 | 58 oz Solid Cast Aluminum Scoop | — | 12 ea |
| 606086 | 85 oz Solid Cast Aluminum Scoop | — | 12 ea |
| 4306 Δ ♦ | 6 oz Polycarbonate Scoop | 07 | 12 ea |
| 4332 Δ ♦ | 32 oz Polycarbonate Scoop | 07 | 12 ea |
| 4364 Δ ♦ | 64 oz Polycarbonate Scoop | 07 | 6 ea |

NSF Listed products are designated with a Δ and may be prefixed with an N

♦ California Residents: Bisphenol A **WARNING:** See appendix A on page 1



SPARTA® PASTRY & BASTING BRUSHES

Sparta Pastry & Basting Brushes have been the **top choice** of discriminating professional chefs the world over for decades. The **high-quality craftsmanship** provides the **best bristle retention in the industry**. You should never sacrifice food safety and with our wide selection of brushes, we have a brush to cover **all of your needs**.



TOP SELLER

SPARTA®
BRUSH
Famous for Quality

Other Brands



Sparta

Superior Food Safety Construction

Epoxy-set ferrules on all Sparta Pastry/Basting Brushes are especially designed for foodservice use; eliminating hazardous bacteria traps commonly found in other brushes. Sparta Pastry/Basting Brushes are available in a wide range of sizes and styles.

Chef Series™ Brushes

- Professional, high-quality lacquered hardwood handles with brown plastic ferrules are the choice of top chefs
- Bristles are epoxy-set to ferrules to provide superior bristle retention and to prevent bacteria harboring air pockets

Sparta Chef Series Croissant Brush

- Extra long bleached boar bristles for use on the most delicate of pastries and foods



Chef Series Basting Brushes

- The professional's choice for use in basting meats and poultry
- Durable sterilized, double-boiled, bleached boar bristles
- Withstands temperatures of up to 500°F

Note: Basting brushes should not be cleaned in dishwashers. Brushes should be dipped in a commercial cleaning solution and rinsed.



For usage information on these and other brushes included in our 21 Key Brushes Set, check out our 21 Key Brush Guide on pages 253-255



Standard(00)

| Prod No | Description | Color | Pack |
|---|--|-------|-------|
| Sparta Chef Series Croissant Brush | | | |
| 40377 | 1.5" Wide Brush with Boar Bristles | 00 | 12 ea |
| Sparta Chef Series Basting Brushes | | | |
| 40370 | 12" Handle with 2" Wide Brush with Boar Bristles | 00 | 12 ea |
| 40371 | 12" Handle with 4" Wide Brush with Boar Bristles | 00 | 12 ea |
| 40372 | 1" Wide Flat Brush with Boar Bristles | 00 | 12 ea |
| 40373 | 1.5" Wide Flat Brush with Boar Bristles | 00 | 12 ea |
| 40374 | 2" Wide Flat Brush with Boar Bristles | 00 | 12 ea |
| 40375 | 3" Wide Flat Brush with Boar Bristles | 00 | 12 ea |
| 40376 | 4" Wide Flat Brush with Boar Bristles | 00 | 12 ea |
| 40380 | 1" Round Brush with Boar Bristles | 00 | 12 ea |



Chef Series Pastry Brushes

- Soft, flagged, white nylon bristles have high fluid retaining capacity and provide a soft touch to delicate pastries
- The finest commercial brushes of their kind
- Offers the performance, delicate touch and long-lasting value by which all others are judged



Meteor Pastry/Basting Brushes

- “Molded-into-the-handle” hook hangs on lip of crocks and containers to prevent bristle burn, melt or distortion
- Use hook to elevate bristles off of counter tops
- Soft flagged bristles are molded into handle to prevent bacteria harboring air pockets
- Available with white nylon bristles or double-boiled, bleached, sterilized, premium boar bristles

Hook hangs on side of crock or elevates bristles off counter tops



Bristles | Heat Distortion Point

| | |
|------------------|-----------------------|
| Synthetic | Up to 350°F (176.7°C) |
| Boar | 500°F (260°C) |
| Silicone | 500°F (260°C) |



| Prod No | Description | Color | Pack |
|---|-------------------------------------|--------|-------|
| Sparta Chef Series Pastry Brushes | | | |
| 40395 | 1" Wide Brush with Nylon Bristles | — | 12 ea |
| 40396 | 1.5" Wide Brush with Nylon Bristles | — | 12 ea |
| 40397 | 2" Wide Brush with Nylon Bristles | — | 12 ea |
| 40398 | 3" Wide Brush with Nylon Bristles | — | 12 ea |
| 40399 | 4" Wide Brush with Nylon Bristles | — | 12 ea |
| 40400 | 1" Round Brush with Nylon Bristles | — | 12 ea |
| Sparta Meteor Pastry/Basting Brushes | | | |
| 40378 | 2" Wide Brush with Boar Bristles | — | 12 ea |
| 40379 | 3" Wide Brush with Boar Bristles | — | 12 ea |
| 40401 | 2" Wide Brush with Nylon Bristles | 02, 14 | 12 ea |
| 40402 | 3" Wide Brush with Nylon Bristles | 02, 14 | 12 ea |



SPARTA® PASTRY & BASTING BRUSHES

Galaxy™ Pastry Brushes

- Bristles are epoxy-set to prevent bacteria harboring air pockets
- One piece plastic handles are easy to clean
- Available with soft flagged nylon bristles
- Select brushes also available with blue nylon bristles for added contrast in working with white frostings or other white foods



Silicone Basting Brush

- Dishwasher safe
- Unique bristle design carries and spreads liquid better than ordinary Silicone basting brushes
- Withstands temperatures up to 500°F
- Convenient molded-in hanging hook grabs pan edges to keep brush from sliding in
- Stain and odor resistant

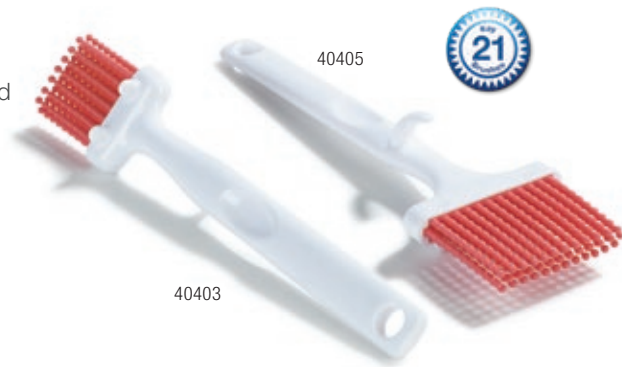

| Prod No | Description | Color | Pack |
|-------------------------------------|--|--------|-------|
| Sparta Galaxy Pastry Brushes | | | |
| 40390 | 1.5" Wide Flat Brush with Nylon Bristles | 02 | 12 ea |
| 40391 | 2" Wide Flat Brush with Nylon Bristles | 02, 14 | 12 ea |
| 40392 | 3" Wide Flat Brush with Nylon Bristles | 02, 14 | 12 ea |
| 40393 | 4" Wide Flat Brush with Nylon Bristles | 02, 14 | 12 ea |
| 40394 | 1" Round Brush with Nylon Bristles | 02 | 12 ea |
| Silicone Basting Brushes | | | |
| 40403 | 2" Silicone Basting Brush | 05 | 12 ea |
| 40405 | 3" Silicone Basting Brush | 05 | 12 ea |

Food Preparation Brushes

Potato Brush

- Patented brush has stiff polyester bristles for aggressive cleaning along with a unique “scraper edge” grip for removing hard to reach blemishes on potatoes and other firm vegetables



Vegetable Brush

- Round loop construction, straight handle with firm bristles



Portioning Cups

- Scoop or transfer ice, liquids or any bulk item
- Features flat sides for efficient scooping on the bottom of bins, food pans or other storage containers
- Made of durable, break-resistant polycarbonate
- Unique U-shaped handle helps keep hands away from food contact areas while scooping
- Sizes are color coded for quick and easy identification
- NSF Listed; dishwasher safe



One Gallon Container

- Ideal for mixing batters, dressings and drinks
- Assorted color toggle lids allow easy access for quick open and close action and color identification
- Tight sealing lid protects against spills
- Durable translucent polypropylene material makes it easy to see contents
- U.S. and metric measurements printed on side panels
- NSF Listed; dishwasher safe



| | | | | |
|--------------|-----------|-----------|-----------|-----------|
| Standard(00) | Brown(01) | White(02) | Black(03) | Beige(06) |
|--------------|-----------|-----------|-----------|-----------|

| Prod No | Description | Color | Pack |
|---|---|-------|-------|
| Sparta Food Preparation Brushes | | | |
| 40412 | 5.75" Potato Brush with Medium Stiff Polyester Bristles | 02 | 12 ea |
| 40164 | 9.5" Vegetable Brush with Stiff Polyester Bristles | 02 | 12 ea |
| Portioning Cups | | | |
| 49110-1 Δ | 9.5 oz Portion Cup | 02 | 6 ea |
| 49112-1 Δ | 12 oz Portion Cup | 06 | 6 ea |
| 49116-1 Δ | 16 oz Portion Cup | 01 | 6 ea |
| 49122-1 Δ | 20 oz Portion Cup | 03 | 6 ea |
| One Gallon Container & Toggles | | | |
| 6400 Δ | 1 Gallon Container | 00 | 2 ea |
| 6401 Δ | Replacement Lid & Assorted Toggles | 00 | 6 ea |

NSF Listed products are designated with a Δ and may be prefixed with an N



MEASURES & SERVING ACCESSORIES

Commercial Measures

- Made of durable polycarbonate
- Offers easy measuring of wet ingredients
- Available in Cup, Pint, Quart, Half Gallon and Gallon sizes with U.S. and metric measurements
- Oval shape facilitates pouring from non-spouted side
- Family of measures nest for storage
- NSF Listed; dishwasher safe



Measurement markings legible on the inside of the container allow faster, more accurate measurement

Measuring Cup

- Durable polycarbonate with 1-cup capacity for measuring liquid ingredients
- Withstands temperatures from -40° to 212°F
- Dishwasher safe



| Prod No | Description | Color | Pack |
|----------------------------|-----------------------------|----------|-------|
| Commercial Measures | | | |
| 43141 Δ ♦ | Cup Size PC Measure | 07, AF07 | 12 ea |
| 43142 Δ ♦ | Pint Size PC Measure | 07, AF07 | 6 ea |
| 43143 Δ ♦ | Quart Size PC Measure | 07, AF07 | 6 ea |
| 43144 Δ ♦ | Half Gallon Size PC Measure | 07, AF07 | 6 ea |
| 43145 Δ ♦ | Gallon Size PC Measure | 07, AF07 | 6 ea |
| Measuring Cup | | | |
| 4315 ♦ | Measuring Cup | 07 | 6 ea |

NSF Listed products are designated with a Δ and may be prefixed with an N

♦ California Residents: Bisphenol A **WARNING:** See appendix A on page 1



Dishers

- Color-coded for easy identification and portion control
- Smooth operating 18-8 stainless steel construction with ribbed plastic handle
- Bowl capacity is stamped on bail
- Number on bail indicates scoops per quart
- NSF Listed; dishwasher safe

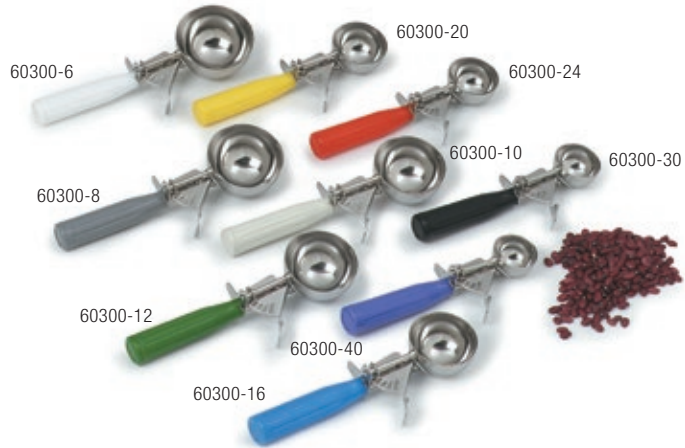

Stainless Steel Measure Misers®

- Portion control spoons in heavy gauge 18-8 stainless steel with durable one-piece construction
- Feature color-coded Kool-Touch handles and built-in pan edge rest
- Dishwasher safe



Prod No **Description** **Pack**

Dishers

| | | |
|------------|----------------------------------|-------|
| 60300-6 Δ | 4.66 oz Disher with White Handle | 12 ea |
| 60300-8 Δ | 4 oz Disher with Gray Handle | 12 ea |
| 60300-10 Δ | 3.75 oz Disher with Ivory Handle | 12 ea |
| 60300-12 Δ | 3.25 oz Disher with Green Handle | 12 ea |
| 60300-16 Δ | 2.75 oz Disher with Blue Handle | 12 ea |
| 60300-20 Δ | 2 oz Disher with Yellow Handle | 12 ea |
| 60300-24 Δ | 1.75 oz Disher with Red Handle | 12 ea |
| 60300-30 Δ | 1.25 oz Disher with Black handle | 12 ea |
| 60300-40 Δ | .88 oz Disher with Orchid handle | 12 ea |

Stainless Steel Measure Misers

| | | |
|--------|---|-------|
| 604360 | 2 oz Solid SS Measure Miser, Red | 12 ea |
| 604361 | 2 oz Perforated SS Measure Miser, Red | 12 ea |
| 604370 | 3 oz Solid SS Measure Miser, Beige | 12 ea |
| 604371 | 3 oz Perforated SS Measure Miser, Beige | 12 ea |
| 604380 | 4 oz Solid SS Measure Miser, Green | 12 ea |
| 604381 | 4 oz Perforated SS Measure Miser, Green | 12 ea |
| 604390 | 6 oz Solid SS Measure Miser, Black | 12 ea |
| 604392 | 8 oz Solid SS Measure Miser, Blue | 12 ea |

NSF Listed products are designated with a Δ and may be prefixed with an N



MEASURE MISERS®

Measure Misers help your kitchen **deliver consistency** to make work easier, reduce waste and **save you money.**

Measure Misers

- Portion control spoon made of break-resistant polycarbonate
- Spoon's flat bottom easily spreads sauces or toppings
- Long handle measure misers have thumb grip for steady control and a notch for resting on pan rim
- Recommended for temperatures up to 212°F
- Withstands dry heat up to 270°F
- 2-year limited warranty
- NSF Listed; dishwasher safe



| Prod No | Description | Color | Pack |
|------------------------------|--|-------|-------|
| Measure Misers | | | |
| Short Handle | | | |
| 4322 ▲◆ | 1-1/2 oz, 7.19" Solid Measure Miser w/Red Measurements | 06 | 12 ea |
| 4324 ▲◆ | 2 oz, 7.13" Solid Measure Miser w/Red Measurements | 06 | 12 ea |
| 4362 ▲◆ | 2 oz, 7.13" Perforated Measure Miser w/Red Measurements | 06 | 12 ea |
| 4326 ▲◆ | 3 oz, 8" Solid Measure Miser w/Blue Measurements | 06 | 12 ea |
| 4328 ▲◆ | 4 oz, 8.25" Solid Measure Miser w/Green Measurements | 06 | 12 ea |
| 4329 ▲◆ | 4 oz, 8.25" Perforated Measure Miser w/Green Measurements | 06 | 12 ea |
| 4330 ▲◆ | 6 oz, 8.63" Solid Measure Miser w/Black Measurements | 06 | 12 ea |
| Standard Handle | | | |
| 4358 ▲◆ | 1-1/2 oz, 11.94" Solid Measure Miser w/Maroon Measurements | 06 | 12 ea |
| 4360 ▲◆ | 2 oz, 11.94" Solid Measure Miser w/Red Measurements | 06 | 12 ea |
| 4361 ▲◆ | 2 oz, 11.94" Perforated Measure Miser w/Red Measurements | 06 | 12 ea |
| 4370 ▲◆ | 3 oz, 12.75" Solid Measure Miser w/Blue Measurements | 06 | 12 ea |
| 4371 ▲◆ | 3 oz, 12.75" Perforated Measure Miser w/Blue Measurements | 06 | 12 ea |
| 4380 ▲◆ | 4 oz, 13" Solid Measure Miser w/Green Measurements | 06 | 12 ea |
| 4381 ▲◆ | 4 oz, 13" Perforated Measure Miser w/Green Measurements | 06 | 12 ea |
| 4390 ▲◆ | 6 oz, 13.38" Solid Measure Miser w/Black Measurements | 06 | 12 ea |
| 4391 ▲◆ | 6 oz, 13.38" Perforated Measure Miser w/Black Measurements | 06 | 12 ea |
| Black Measure Misers* | | | |
| 4360-5 ▲◆ | 2 oz, 11.94" Solid Measure Miser | 03 | 12 ea |
| 4370-5 ▲◆ | 3 oz, 12.75" Solid Measure Miser | 03 | 12 ea |
| 4380-5 ▲◆ | 4 oz, 13" Solid Measure Miser | 03 | 12 ea |
| 4381-5 ▲◆ | 4 oz, 13" Perforated Measure Miser | 03 | 12 ea |
| 4390-5 ▲ | 6 oz, 13.38" Solid Measure Miser | 03 | 12 ea |

NSF Listed products are designated with a ▲ and may be prefixed with an N
 *Black measure misers do not have color-coding

◆ California Residents: Bisphenol A **WARNING:** See appendix A on page 1



Long lasting acetal Color-Coded Measure Misers ensure employees **deliver the consistency** your customers expect without compromising durability.

Color-Coded Measure Misers

- Portion control spoon made of break-resistant acetal material
- Each color represents a different size for easy recognition and consistency
- Spoon's flat bottom easily spreads sauces or toppings
- 4694 features a deep cup style that allows for easier access inside small food pans
- Long handle measure misers have thumb grip for steady control and a notch for resting on pan rim
- Recommended for temperatures up to 212°F
- Withstands dry heat up to 270°F
- BPA Free
- 2-year limited warranty
- NSF Listed; dishwasher safe

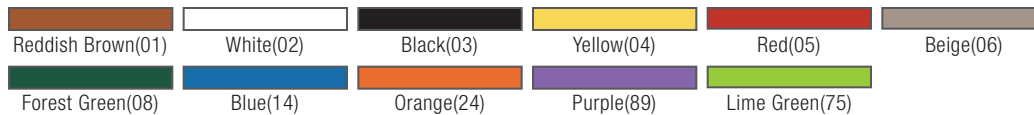

| Prod No | Description | Color | Pack | Prod No | Description | Color | Pack |
|-----------------------------------|---------------------------------------|--------|-------|-----------------------------------|--------------------------------|--------|-------|
| Color-Coded Measure Misers | | | | Color-Coded Measure Misers | | | |
| Short Handle | | | | Long Handle | | | |
| 4921 Δ | 1 oz, 6.5" Solid Spoon | 04, 89 | 12 ea | 3956 Δ | 1 oz, 11.5" Solid Spoon | 04, 89 | 12 ea |
| 4923 Δ | 1 oz, 6.5" Perforated Spoon | 04 | 12 ea | 3957 Δ | 1 oz, 11.25" Perforated Spoon | 04 | 12 ea |
| 4932 Δ | 1.25 oz, 7.25" Solid Spoon | 75 | 12 ea | 3958 Δ | 1.5 oz, 11.5" Solid Spoon | 01 | 12 ea |
| 4965 Δ | 1.25 oz, 7.25" Perforated Spoon | 75 | 12 ea | 3959 Δ | 1.5 oz, 11.5" Perforated Spoon | 01 | 12 ea |
| 4922 Δ | 1.5 oz, 7" Solid Spoon | 01 | 12 ea | 3960 Δ | 2 oz, 11.9" Solid Spoon | 05, 89 | 12 ea |
| 4961 Δ | 1.5 oz, 7" Perforated Spoon | 01 | 12 ea | 3961 Δ | 2 oz, 11.9" Perforated Spoon | 05 | 12 ea |
| 4924 Δ | 2 oz, 7.10" Solid Spoon | 05, 89 | 12 ea | 3970 Δ | 3 oz, 11.75" Solid Spoon | 02 | 12 ea |
| 4962 Δ | 2 oz, 7.10" Perforated Spoon | 05, 89 | 12 ea | 3971 Δ | 3 oz, 11.75" Perforated Spoon | 02 | 12 ea |
| 4925 Δ | 2.5 oz, 7.10" oz Solid Spoon | 24 | 12 ea | 3980 Δ | 4 oz, 13" Solid Spoon | 08, 89 | 12 ea |
| 4963 Δ | 2.5 oz, 7.10" Perforated Spoon | 24 | 12 ea | 3981 Δ | 4 oz, 13" Perforated Spoon | 08, 89 | 12 ea |
| 4926 Δ | 3 oz, 8" Solid Spoon | 02, 89 | 12 ea | 3990 Δ | 6 oz, 13.4" Solid Spoon | 03 | 12 ea |
| 4927 Δ | 3 oz, 8" Perforated Spoon | 02 | 12 ea | 3991 Δ | 6 oz, 13.4" Perforated Spoon | 03 | 12 ea |
| 4928 Δ | 4 oz, 8.25" Solid Spoon | 08, 89 | 12 ea | 3992 Δ | 8 oz, 13.25" Solid Spoon | 14 | 12 ea |
| 4929 Δ | 4 oz, 8.25" Perforated Spoon | 08 | 12 ea | 3993 Δ | 8 oz, 13.25" Perforated Spoon | 14 | 12 ea |
| 4933 Δ | 5 oz, 8.62" Solid Spoon | 06 | 12 ea | | | | |
| 4966 Δ | 5 oz, 8.62" Perforated Spoon | 06 | 12 ea | | | | |
| 4930 Δ | 6 oz, 8.62" Solid Spoon | 03, 89 | 12 ea | | | | |
| 4967 Δ | 6 oz, 8.62" Perforated Spoon | 03 | 12 ea | | | | |
| 4964 Δ | 6 oz, 8.62" Deep Cup Perforated Spoon | 03 | 12 ea | | | | |
| 4931 Δ | 8 oz, 8.62" Solid Spoon | 14 | 12 ea | | | | |
| 4968 Δ | 8 oz, 8.62" Perforated Spoon | 14 | 12 ea | | | | |

NSF Listed products are designated with a Δ and may be prefixed with an N



DREDGES, COLANDERS, BOWLS & SKIMMERS

Metal Dredge

- Heavy-duty seamless dredges in aluminum
- 18-8 mirror polish stainless with wide screw tops for easy filling
- Dishwasher safe



6031

Shaker/Dredge

- Durable break-resistant polycarbonate shaker can be customized with your logo
- Call Customer Service at 1-800-654-8210 for custom imprinting information; also ask about our BPA-free versions available by special order
- Additional lids can be purchased separately to accommodate different toppings
- Different hole sizes available for portioning materials that vary in size



4261

4271

4251



4270

4230

4250

4260



| Prod No | Description | Color | Pack |
|---|--------------------------------------|-------|-------|
| Metal Dredge | | | |
| 6031 | Alumilite Dredge with Handle | — | 12 ea |
| Polycarbonate Shaker/Dredge & Lids | | | |
| 4250 ♦ | Dredge with Medium Ground, Rose Lid | 55 | 12 ea |
| 4260 ♦ | Dredge with Cheese, Yellow Lid | 04 | 12 ea |
| 4270 ♦ | Dredge with Salt & Pepper, Beige Lid | 06 | 12 ea |
| 4230 ♦ | Dredge with Translucent Parsley Lid | 30 | 12 ea |
| 4231 | Translucent Parsley Lid | 30 | 12 ea |
| 4251 | Rose Medium Ground Lid | 55 | 12 ea |
| 4261 | Yellow Cheese Lid | 04 | 12 ea |
| 4271 | Beige Salt & Pepper Lid | 06 | 12 ea |
| Wire Mesh Strainers | | | |
| 601526 | 6" Bowl Mesh Strainer | — | 12 ea |
| 601527 | 7" Bowl Mesh Strainer | — | 12 ea |
| 601528 | 8" Bowl Mesh Strainer | — | 12 ea |
| 601529 | 9" Bowl Mesh Strainer | — | 12 ea |

♦ California Residents: Bisphenol A **WARNING:** See appendix A on page 1

Colanders

- Seamless satin finish aluminum construction with rolled top edge for extra strength
- Sturdy handles are securely riveted on sides
- Available in extra heavy or standard gauge aluminum



Spaghetti Strainer

- Heavy gauge aluminum strainer has riveted plated steel handle
- Perfect for rinsing and straining pastas and vegetables
- Front hook for resting on stock pot
- Hole diameter 2.0 Mm
- Dishwasher Safe



Melamine Mixing Bowls

- Heavy-duty melamine is safe for temperatures up to 212°F
- Bowls are break and stain-resistant
- Not recommended for microwave use
- Dishwasher safe



Wire Mesh Skimmers

- Heavy-duty construction
- Skimmers lift food from fryer
- Sturdy handles with hanging loops
- Nickel plated construction resists corrosion

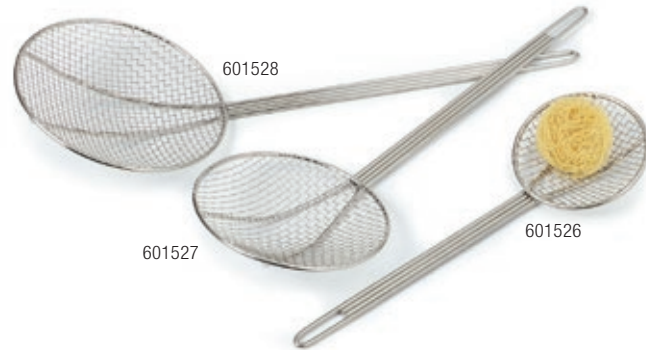

| Prod No | Description | Color | Pack |
|------------------------------|--------------------------------|--------|-------|
| Colanders | | | |
| 60275 | 11 qt Heavy-Weight Colander | — | 6 ea |
| 60277 | 16 qt Heavy-Weight Colander | — | 6 ea |
| 60278 | 8 qt Standard Weight Colander | — | 6 ea |
| 60279 | 11 qt Standard Weight Colander | — | 6 ea |
| 60280 | 16 qt Standard Weight Colander | — | 6 ea |
| Spaghetti Strainer | | | |
| 60830 | 4 qt Spaghetti Strainer | — | 12 ea |
| Melamine Mixing Bowls | | | |
| 43744 | 1.5 qt, 8" Mixing Bowl | 02, 92 | 12 ea |
| 43743 | 3 qt, 9.75" Mixing Bowl | 02, 92 | 12 ea |



COLOR-CODED SPATULAS & SCRAPERS

Sparta® Spatulas & Paddle Scrapers

- Perfect for general mixing and stirring
- Long handle versions are ideal for vats and large pots
- Stainless steel or nylon/polyethylene scraper available
- Smooth finish, water-proof construction for easy clean-up
- Replacement blades are available for this product

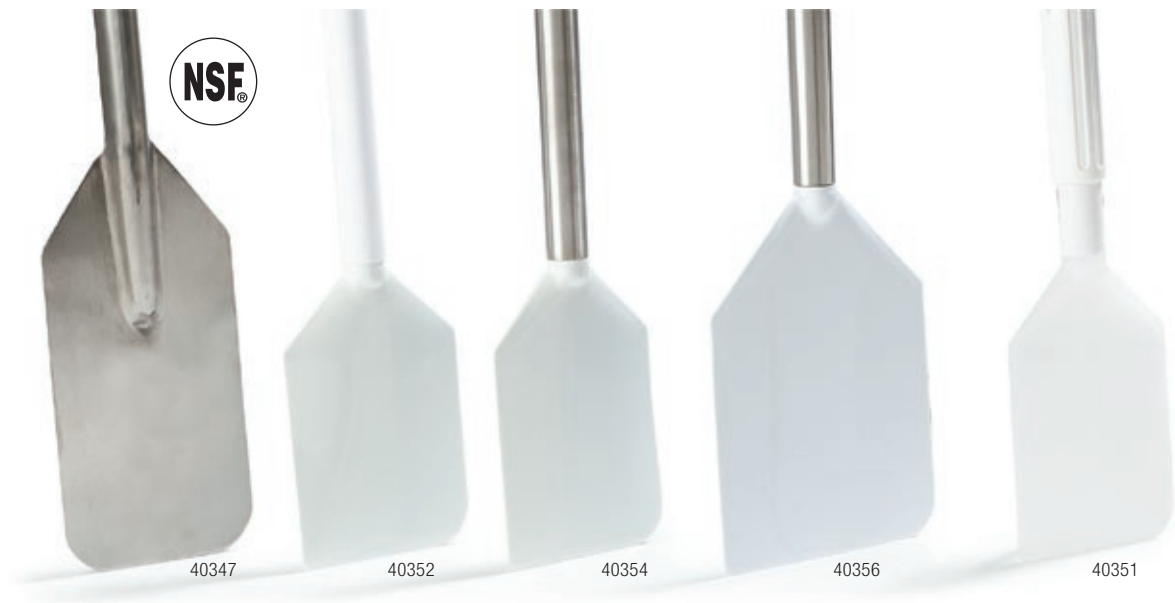

| Prod No | Description | Color | Pack |
|--|---|-------|------|
| Sparta Spatulas & Paddle Scrapers | | | |
| 40347 ▲ | 36" Stainless Steel Paddle Scraper | — | 6 ea |
| 40349 ▲ | 48" Stainless Steel Paddle Scraper | — | 6 ea |
| 40359 ▲ | 60" Stainless Steel Paddle Scraper | — | 6 ea |
| 40350 | 13.5" Nylon Handle with 4.5" x 7.5" Nylon Spatula Scraper | 02 | 6 ea |
| 40351 | 13.5" Nylon Handle with 4.5" x 7.5" Polyethylene Soft Spatula Scraper | 00 | 6 ea |
| 40352 | 40" Nylon Handle with 4.5" x 7.5" Nylon Paddle Scraper | 02 | 6 ea |
| 40353 | 48" Nylon Handle with 4.5" x 7.5" Nylon Paddle Scraper | 00 | 6 ea |
| 40354 | 48" Stainless Steel Handle with 4.5" x 7.5" Nylon Paddle Scraper | 00 | 6 ea |
| 40355 | 72" Stainless Steel Handle with 4.5" x 7.5" Nylon Paddle Scraper | 00 | 6 ea |
| 40356 | 48" Stainless Steel Handle with 6.5" x 9" Nylon Paddle Scraper | 00 | 3 ea |
| 40361 | 4.5" x 7" Standard Nylon Replacement Blade | 02 | 6 ea |
| 40362 | 6.5" x 9" Large Nylon Replacement Blade | 00 | 6 ea |

NSF Listed products are designated with a ▲ and may be prefixed with an N

Sparta® Color-Coded Spatulas & Paddle Scrapers

- Spatulas are perfect for general mixing and stirring
- Standard Nylon (300°F) or soft flexible Polyethylene (150°F) blades will sharpen and contour to your specific application with usage
- Smooth finished, water-proof construction for easy clean-up
- Replacement blades are available for this product



40352C



40353C



40350C



403561C



| Prod No | Description | Color | Pack |
|--|--|----------------|------|
| Color-Coded Sparta Spatulas & Paddle Scrapers | | | |
| 40350C | Sparta Scraper with Plastic Handle, 13.5" L | 04, 05, 09, 14 | 6 ea |
| 40352C | Sparta Paddle Scraper with Plastic Handle, 40" L | 04, 05, 09, 14 | 6 ea |
| 40353C | Sparta Paddle Scraper with Plastic Handle, 48" L | 04, 05, 09, 14 | 6 ea |
| 40361C | Sparta Standard Nylon Replacement Blade, 7.5" x 4.5" L | 04, 05, 09, 14 | 6 ea |



TONGS, WHIPS & TOOLS

Tongs

Heavy-Duty Utility Tongs

- Heavy 20 gauge stainless steel with flat spring for long-lasting service
- Dishwasher safe

Spectrum® Dura-Kool™ Tongs

- Color-coded Dura-Kool handles provide easy visual for zone isolation
- Single-piece, heavy-duty stainless construction eliminates food traps for more sanitary use
- Spring action hinge won't break, also provides convenient hook for storage

Carlisle's Spectrum System supports your HACCP program by promoting zone isolation and reducing the risk of cross-contamination with our complete offering of color-coded kitchen tools and cleaning accessories



Sparta® Chef Series™ French Whips

- Sanitary fully-sealed construction eliminates bacteria harboring food traps
- Rust-free 18-8 stainless construction with heavy gauge spring wire loops
- Perfectly weighted and balanced for heavy mixing, stirring and beating batters, sauces and other thicker mixtures



| Prod No | Description | Color | Pack |
|--|--|--------------------|-------|
| Heavy-Duty Utility Tongs | | | |
| 607550 | 9.5" Heavy-Duty Utility Tongs | — | 12 ea |
| 607552 | 12" Heavy-Duty Utility Tongs | — | 12 ea |
| 607556 | 16" Heavy-Duty Utility Tongs | — | 12 ea |
| Spectrum Dura-Kool Tongs | | | |
| 607560 Δ | 9.5" Spectrum Dura-Kool Tong | 03, 04, 05, 09, 14 | 12 ea |
| 607562 Δ | 12" Spectrum Dura-Kool Tong | 03, 04, 05, 09, 14 | 12 ea |
| 607566 Δ | 16" Spectrum Dura-Kool Tong | 03, 05, 09, 14 | 12 ea |
| Sparta Chef Series French Whips | | | |
| 40681 | 36" Chef Series Heavy-Weight French Whip | — | 2 ea |
| 40682 | 48" Chef Series Heavy-Weight French Whip | — | 2 ea |

NSF Listed products are designated with a Δ and may be prefixed with an N

High Heat Serving Spoons & Turner

- High heat material withstands temperatures from -40°F to 375°F without melting or transferring heat
- Helps prevent scratching on coated surfaces
- Notched handle with hole for hanging
- NSF Listed; dishwasher safe

High Heat Serving Spoons

- Notched handle allows spoon to rest on edge of food pan



Oil Bottle & Sprayer

- 16 oz capacity to keep oil fresh
- Amber color protects light sensitive oils
- Value alternative to aerosol cans of oil
- Pre-labeled to ensure segregation from cleaning bottles
- Thread is compatible with standard sprayers

Sprayer (sold separately)

- Adjustable spray nozzle
- Metered application reduces food waste and improves consistency



Sparta® Foodservice Shovels

- Heavy duty one-piece plastic construction
- Supports heavy loads, safe to use with food, will not rust and cleans up easily



| Prod No | Description | Color | Pack |
|--|--|------------|-------|
| High Heat Serving Spoons & Turner | | | |
| 4415 Δ | 11" Solid High Heat Serving Spoon | 03 | 12 ea |
| 4416 Δ | 11" Perforated High Heat Serving Spoon | 03 | 12 ea |
| 4425 Δ | 13" Solid High Heat Serving Spoon | 03 | 12 ea |
| 4426 Δ | 13" Perforated High Heat Serving Spoon | 03 | 12 ea |
| 4900 Δ | 13" Slotted Turner | 03, 13 | 12 ea |
| Oil Bottle & Sprayer | | | |
| 3816 | 16 oz Amber Bottle with Label | 13 | 12 ea |
| 3817 | Trigger Sprayer | 00 | 12 ea |
| Sparta Foodservice Shovels | | | |
| 41076-1 | 11" Wide Foodservice Shovel | 02 | 1 ea |
| 41076 | 11" Wide Foodservice Shovel | 02, 04, 05 | 6 ea |
| 41077-1 | 14" Wide Foodservice Shovel | 02 | 1 ea |
| 41077 | 14" Wide Foodservice Shovel | 02, 04, 05 | 6 ea |

NSF Listed products are designated with a Δ and may be prefixed with an N



CARLISLE
FOODSERVICE PRODUCTS

20L — 22 qt.
20L — 20 qt.
15L — 16 qt.
10L — 12 qt.
10L — 10 qt.
8 qt.

TOUGH VERSATILE SAFE INNOVATIVE **STORAGE & HANDLING SUPPLIES**

From distinct color-coding to easy-clean surfaces, Carlisle ensures that all of our products are designed to safely store, handle and transport food. You can count on Carlisle to help you keep food fresh, reduce food safety risks, reduce waste and operate efficiently



STORPLUS™

COMPLETE STORAGE SOLUTIONS

Only Carlisle offers such a wide selection of storage containers for your foodservice operation.

All StorPlus products offer the quality construction and ease of use Carlisle is known for. They are tough and durable, plus these NSF Listed products are designed to support your HACCP program. Product features are detailed in this catalog section.



Food Pans, Lids & Accessories

Polycarbonate and BPA-Free High Heat



Coldmaster®

Innovative products that are a perfect compliment to your StorPlus containers

See pages 108-117 for a complete listing



EZ Access Lids

Efficient and convenient flip hinge lid that keeps food safe

See pages 220-222 for a complete listing



Specialty Handled High Heat

Help products stay warm and fresh for your customers

See page 223 for a complete listing





Storage Boxes & Lids

Color-Coded For All Your Storage Needs



Squares

Easy-To-Read Capacity Indicators
Built-In Handles



Rounds

Easy-To-Read Capacity Indicators
Built-In Handles

3 Material Options

Carlisle Offers Three
Food Pan Options

Polycarbonate, High Heat,
Stainless Steel





STORPLUS™ FOOD PANS

StorPlus is perfect for holding food day after day in all cold applications including buffets, cold wells, service line applications and fridge/freezer storage.

Food Pans

- Smooth interior makes clean-up easy
- Reinforced corners prevent chips and cracks, stand up to drops and use day after day
- Universally stackable with all food pan products on the market
- Spoonable bottoms allow easy removal of contents and reduction of food waste
- Polycarbonate containers can withstand temperatures from -40°F to 212°F
- High-heat pans excel in high temperature applications and are BPA Free (-40°F to 375°F)
- Compatible with Carlisle StorPlus Universal Lids, Smart Lids, Drain Grates and EZ Access Lids
- Textured non-slip finish on corners, sides, bottom and lid reduce scratches
- Molded-in capacity indicators are listed in both quarts and liters
- NSF Certified; Made in the USA; Dishwasher Safe



EZ Access Lids

- 50% to 60% larger opening improves hand and utensil access; reduces food waste
- Snug lid stays in place during routine opening; never flips off
- Clean design eliminates dangerous food traps found on other hinged lid designs
- The perfect solution for salad, cucumbers, buffets, prep stations and more
- Compliments Coldmaster and CoolCheck pans
- One-half and one-third sizes available with double notch for multiple portioning options
- Double-hinged design handles the abuse of the most demanding foodservice applications
- Convenient molded-in peg hole
- NSF Listed; dishwasher safe



Universal Food Pan Lids

- Fit Carlisle StorPlus Food Pans as well as other major brands on the market
- Features a hanging hole for easy storage
- Fits both Gastronorm and standard size food pans
- Carlisle lids stack with themselves for easy storage
- Available in polycarbonate or high heat material
- NSF Listed; dishwasher safe





Smart Lids™

- Unique inside seal design provides superior leak-resistance and keeps your foods fresher, longer
- Perfect for transporting foods to off site locations
- Smart Lids (combined with StorPlus Food Pans) fit inside Cateraide Top Loaders and End Loaders (shown on pages 171-177)
- Polyethylene material is dishwasher safe; for use in -40°F to 180°F
- Designed exclusively to fit StorPlus Food Pans



Smart Lid's unique inside seal design provides superior leak-resistance; protects against spills

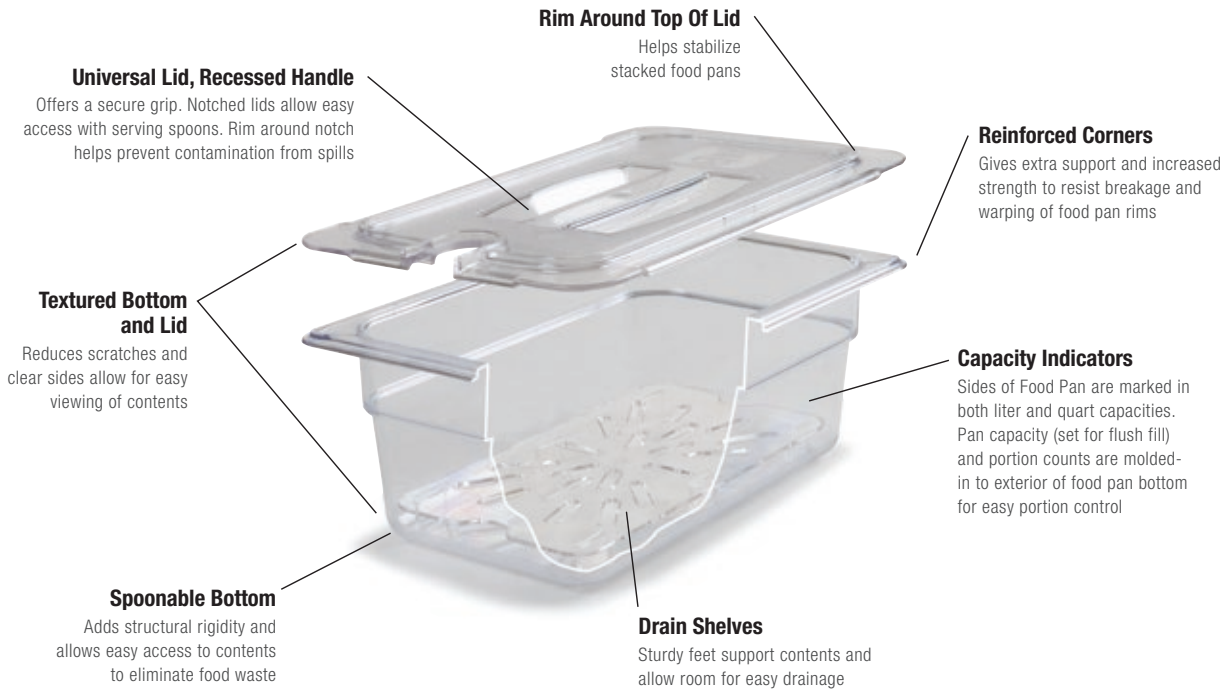

Suggested Pan Layout

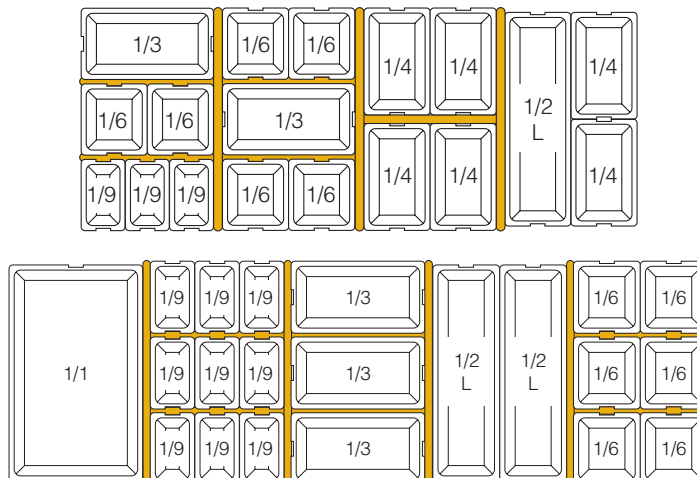



STORPLUS™ FOOD PANS AND LIDS

Polycarbonate Food Pans & Lids

- Smooth interior makes clean-up easy.
- Reinforced corners prevent chips and cracks, stand up to drops and use day after day
- Universally stackable with all food pan products on the market
- Spoonable bottoms allow easy removal of contents and reduction of food waste
- Polycarbonate containers can withstand temperatures from -40°F to 212°F
- Compatible with Carlisle StorPlus Universal Lids, Smart Lids, Drain Grates and EZ Access Lids
- Textured non-slip finish on corners, sides, bottom and lid reduce scratches
- Molded-in capacity indicators are listed in both quarts and liters
- NSF Certified; Made in the USA; Dishwasher Safe

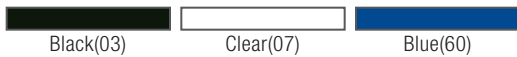

| Prod No | Description | Color | Pack |
|--|-----------------------------|--------|------|
| Full-Size – 20.75" x 12.75" | | | |
| 10200B Δ♦ | Pan – 2.5" (7.6 qt) | 03, 07 | 6 ea |
| 10201B Δ♦ | Pan – 4" (12.7 qt) | 03, 07 | 6 ea |
| 10202B Δ♦ | Pan – 6" (19.4 qt) | 03, 07 | 6 ea |
| 10203B Δ♦ | Pan – 8" (25.9 qt) | 03, 07 | 6 ea |
| 10215 Δ♦ | Drain Shelf | 07 | 6 ea |
| Lids – Fits All Full-Size Pans | | | |
| 10212B | Smart Lid, Unnotched | 60 | 6 ea |
| 10210U Δ♦ | Handled Lid, Unnotched | 07 | 6 ea |
| 10211U Δ♦ | Handled Lid, Single Notched | 07 | 6 ea |
| 10216U Δ♦ | Flat Lid, Unnotched | 07 | 6 ea |
| 10217U Δ♦ | Flat Lid, Single Notched | 07 | 6 ea |
| One-Half Size – 12.75" x 10.38" | | | |
| 10220B Δ♦ | Pan – 2.5" (3.6 qt) | 03, 07 | 6 ea |
| 10221B Δ♦ | Pan – 4" (5.6 qt) | 03, 07 | 6 ea |
| 10222B* Δ♦ | Pan – 6" (8.7 qt) | 03, 07 | 6 ea |
| 10223B Δ♦ | Pan – 8" (11.4 qt) | 07 | 6 ea |
| 10235 Δ♦ | Drain Shelf | 07 | 6 ea |

| Prod No | Description | Color | Pack |
|--|-----------------------------|--------|------|
| EZ Access Lids – One Half Size | | | |
| 10238Z Δ♦ | Handled Lid, Unnotched | 07 | 6 ea |
| 10239Z Δ♦ | Handled Lid, Single Notched | 07 | 6 ea |
| 10240Z Δ♦ | Handled Lid, Double Notched | 07 | 6 ea |
| Lids – Fits All One-Half Size Pans | | | |
| 10232B | Smart Lid, Unnotched | 60 | 6 ea |
| 10230U Δ♦ | Handled Lid, Unnotched | 07 | 6 ea |
| 10231U Δ♦ | Handled Lid, Single Notched | 07 | 6 ea |
| 10236U Δ♦ | Flat Lid, Unnotched | 07 | 6 ea |
| One-Half Long Size – 20.75" x 6.25" | | | |
| 10240B Δ♦ | Pan – 2.5" (2.9 qt) | 03, 07 | 6 ea |
| 10241B Δ♦ | Pan – 4" (5.1 qt) | 03, 07 | 6 ea |
| Lids – Fits All One-Half Long Size Pans | | | |
| 10250U Δ♦ | Handled Lid, Unnotched | 07 | 6 ea |
| 10256U Δ♦ | Flat Lid, Unnotched | 07 | 6 ea |

NSF Listed products are designated with a Δ and may be prefixed with an N
 ♦ California Residents: Bisphenol A **WARNING:** See appendix A on page 1

EZ Access Lids

- 50% to 60% larger opening improves hand and utensil access; reduces foodwaste
- Snug lid stays in place during routine opening; never flips off
- Clean design eliminates dangerous food traps found on other hinged lid designs
- The perfect solution for salad, cucumbers, buffets, prep stations and more
- Compliment your Coldmaster and CoolCheck pans
- One-half and one-third sizes available with double notch for multiple portioning options
- Double-hinged design handles the abuse of the most demanding foodservice applications
- Convenient molded-in peg hole
- NSF Listed; dishwasher safe

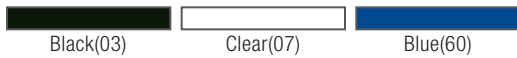

| Prod No | Description | Color | Pack |
|--|-----------------------------|--------|------|
| One-Third Size – 12.75" x 7" | | | |
| 30660 Δ ♦ | Pan – 2.5" (2.4 qt) | 03, 07 | 6 ea |
| 30661 Δ ♦ | Pan – 4" (3.8 qt) | 03, 07 | 6 ea |
| 30662 Δ ♦ | Pan – 6" (5.7 qt) | 03, 07 | 6 ea |
| 30669 Δ ♦ | Pan – 8" (7.3 qt) | 03, 07 | 6 ea |
| 30670 Δ ♦ | Drain Shelf | 07 | 6 ea |
| EZ Access Lids – One Third Size | | | |
| 10278Z Δ ♦ | Handled Lid, Unnotched | 07 | 6 ea |
| 10279Z Δ ♦ | Handled Lid, Single Notched | 07 | 6 ea |
| 10280Z Δ ♦ | Handled Lid, Double Notched | 07 | 6 ea |
| Lids – Fits All One-Third Size Pans | | | |
| 30580 | Smart Lid, Unnotched | 60 | 6 ea |
| 10270U Δ ♦ | Handled Lid, Unnotched | 07 | 6 ea |
| 10271U Δ ♦ | Handled Lid, Single Notched | 07 | 6 ea |
| 10276U Δ ♦ | Flat Lid, Unnotched | 07 | 6 ea |
| 10277U Δ ♦ | Flat Lid, Single Notched | 07 | 6 ea |
| One-Quarter Size – 10.25" x 6.38" | | | |
| 30680 Δ ♦ | Pan – 2.5" (1.7 qt) | 03, 07 | 6 ea |
| 30681 Δ ♦ | Pan – 4" (2.8 qt) | 03, 07 | 6 ea |
| 30682 Δ ♦ | Pan – 6" (4.0 qt) | 03, 07 | 6 ea |
| 30695 Δ ♦ | Drain Shelf | 07 | 6 ea |
| Lids – Fits All One-Quarter Size Pans | | | |
| 30581 | Smart Lid, Unnotched | 60 | 6 ea |
| 10290U Δ ♦ | Handled Lid, Unnotched | 07 | 6 ea |
| 10291U Δ ♦ | Handled Lid, Single Notched | 07 | 6 ea |
| 10296U Δ ♦ | Flat Lid, Unnotched | 07 | 6 ea |
| 10297U Δ ♦ | Flat Lid, Single Notched | 07 | 6 ea |



| Prod No | Description | Color | Pack |
|--|-----------------------------|--------|------|
| One-Sixth Size – 6.75" x 6.38" | | | |
| 30683 Δ ♦ | Pan – 2.5" (1.1 qt) | 03, 07 | 6 ea |
| 30684 Δ ♦ | Pan – 4" (1.7 qt) | 03, 07 | 6 ea |
| 30685 Δ ♦ | Pan – 6" (2.5 qt) | 03, 07 | 6 ea |
| 30689 Δ ♦ | Drain Shelf | 07 | 6 ea |
| EZ Access Lids – One Sixth Size | | | |
| 10318Z Δ ♦ | Handled Lid, Unnotched | 07 | 6 ea |
| 10319Z Δ ♦ | Handled Lid, Single Notched | 07 | 6 ea |
| Lids – Fits All One-Sixth Size Pans | | | |
| 30582 | Smart Lid, Unnotched | 60 | 6 ea |
| 10310U Δ ♦ | Handled Lid, Unnotched | 07 | 6 ea |
| 10311U Δ ♦ | Handled Notched Lid | 07 | 6 ea |
| 10316U Δ ♦ | Flat Lid, Unnotched | 07 | 6 ea |
| 10317U Δ ♦ | Flat Lid, Single Notched | 07 | 6 ea |
| One-Ninth Size – 6.75" x 4.25" | | | |
| 30686 Δ ♦ | Pan – 2.5" (0.7 qt) | 03, 07 | 6 ea |
| 30687 Δ ♦ | Pan – 4" (1.0 qt) | 03, 07 | 6 ea |
| 30688 Δ ♦ | Pan – 6" (1.4 qt) | 03, 07 | 6 ea |
| 10335 Δ ♦ | Drain Shelf | 07 | 6 ea |
| EZ Access Lids – One Ninth Size | | | |
| 10338Z Δ ♦ | Handled Lid, Unnotched | 07 | 6 ea |
| 10339Z Δ ♦ | Handled Lid, Single Notched | 07 | 6 ea |
| Lids – Fits All One-Ninth Size Pans | | | |
| 30583 | Smart Lid, Unnotched | 60 | 6 ea |
| 10336U Δ ♦ | Flat Lid, Unnotched | 07 | 6 ea |
| 10337U Δ ♦ | Flat Lid, Single Notched | 07 | 6 ea |

NSF Listed products are designated with a Δ and may be prefixed with an N
 ♦ California Residents: Bisphenol A **WARNING:** See appendix A on page 1



High Heat Food Pans & Lids

- High heat pans excel in high temperature applications (-40°F to 375°F)
- For a leak-resistant seal use Smart Lids



| | Black(03) | Amber(13) | Blue(60) |
|--|-------------------------------|--------------|-------------|
| Prod No | Description | Color | Pack |
| Full-Size – 20.75" x 12.75" | | | |
| 10400B Δ | Pan – 2.5" (7.6 qt) | 03, 13 | 6 ea |
| 10401B Δ | Pan – 4" (12.7 qt) | 03, 13 | 6 ea |
| 10402B Δ | Pan – 6" (19.4 qt) | 03, 13 | 6 ea |
| 10415 Δ | Drain Shelf | 13 | 6 ea |
| Lids – Fits All Full-Size Pans | | | |
| 10212B | Smart Lid, Unnotched | 60 | 6 ea |
| 10410U Δ | Handled Lid, Unnotched | 13 | 6 ea |
| 10411U Δ | Handled Lid, Single Notched | 13 | 6 ea |
| 10416U Δ | Flat Lid, Unnotched | 13 | 6 ea |
| 10417U Δ | Flat Notched Lid | 13 | 6 ea |
| One-Half Size – 12.75" x 10.38" | | | |
| 10420B Δ | Pan – 2.5" (3.6 qt) | 03, 13 | 6 ea |
| 10421B Δ | Pan – 4" (5.6 qt) | 03, 13 | 6 ea |
| 10422B Δ | Pan – 6" (8.7 qt) | 03, 13 | 6 ea |
| 10423B Δ | Pan – 8" (11.4 qt) | 03, 13 | 6 ea |
| 10435 Δ | Drain Shelf | 13 | 6 ea |
| EZ Access Lids – One Half Size | | | |
| 10438Z Δ | EZ Access Lid, Unnotched | 13 | 6 ea |
| 10439Z Δ | EZ Access Lid, Single Notched | 13 | 6 ea |
| 10440Z | EZ Access Lid, Double Notched | 13 | 6 ea |
| Lids – Fits All One-Half Size Pans | | | |
| 10232B | Smart Lid, Unnotched | 60 | 6 ea |
| 10430U Δ | Handled Lid, Unnotched | 13 | 6 ea |
| 10431U Δ | Handled Lid, Single Notched | 13 | 6 ea |
| 10436U Δ | Flat Lid, Unnotched | 13 | 6 ea |
| 10437U Δ | Flat Lid, Single Notched | 13 | 6 ea |
| One-Half Long Size – 20.75" x 6.25" | | | |
| 10440B Δ | Pan – 2.5" (2.9 qt) | 03, 13 | 6 ea |
| 10441B Δ | Pan – 4" (5.1 qt) | 03, 13* | 6 ea |
| Lids – Fits All One-Half Long Size Pans | | | |
| 10450U Δ | Handled Lid, Unnotched | 13 | 6 ea |
| One-Third Size – 12.75" x 7" | | | |
| 30860 Δ | Pan – 2.5" (2.4 qt) | 03, 13 | 6 ea |
| 30861 Δ | Pan – 4" (3.8 qt) | 03, 13 | 6 ea |
| 30862 Δ | Pan – 6" (5.7 qt) | 03, 13 | 6 ea |
| 30869 Δ | Pan – 8" (7.3 qt) | 03, 13 | 6 ea |
| 30870 Δ | Drain Shelf | 13 | 6 ea |
| EZ Access Lids – One Third Size | | | |
| 10478Z Δ | EZ Access Lid, Unnotched | 13 | 6 ea |
| 10479Z Δ | EZ Access Lid, Single Notched | 13 | 6 ea |
| 10480Z Δ | EZ Access Lid, Double Notched | 13 | 6 ea |

| Prod No | Description | Color | Pack |
|--|-------------------------------|--------|------|
| Lids – Fits All One-Third Size Pans | | | |
| 30580 | Smart Lid, Unnotched | 60 | 6 ea |
| 10470U Δ | Handled Lid, Unnotched | 13 | 6 ea |
| 10471U Δ | Handled Lid, Single Notched | 13 | 6 ea |
| 10476U Δ | Flat Lid, Unnotched | 13 | 6 ea |
| 10477U Δ | Flat Lid, Single Notched | 13 | 6 ea |
| One-Quarter Size – 10.25" x 6.38" | | | |
| 30880 Δ | Pan – 2.5" (1.7 qt) | 03, 13 | 6 ea |
| 30881 Δ | Pan – 4" (2.8 qt) | 03, 13 | 6 ea |
| 30882 Δ | Pan – 6" (4.0 qt) | 03, 13 | 6 ea |
| 30895 Δ | Drain Shelf | 13 | 6 ea |
| Lids – Fits All One-Quarter Size Pans | | | |
| 30581 | Smart Lid, Unnotched | 60 | 6 ea |
| 10490U Δ | Handled Lid, Unnotched | 13 | 6 ea |
| 10491U Δ | Handled Lid, Single Notched | 13 | 6 ea |
| 10496U Δ | Flat Lid, Unnotched | 13 | 6 ea |
| One-Sixth Size – 6.75" x 6.38" | | | |
| 30883 Δ | Pan – 2.5" (1.1 qt) | 03, 13 | 6 ea |
| 30884 Δ | Pan – 4" (1.7 qt) | 03, 13 | 6 ea |
| 30885 Δ | Pan – 6" (2.5 qt) | 03, 13 | 6 ea |
| 30896 Δ | Drain Shelf | 13 | 6 ea |
| EZ Access Lids – One Half Size | | | |
| 10518Z Δ | EZ Access Lid, Unnotched | 13 | 6 ea |
| 10519Z Δ | EZ Access Lid Notched | 13 | 6 ea |
| Lids – Fits All One-Sixth Size Pans | | | |
| 30582 | Smart Lid, Unnotched | 60 | 6 ea |
| 10510U Δ | Handled Lid, Unnotched | 13 | 6 ea |
| 10511U Δ | Handled Lid, Single Notched | 13 | 6 ea |
| 10516U Δ | Flat Lid, Unnotched | 13 | 6 ea |
| One-Ninth Size – 6.75" x 4.25" | | | |
| 30886 Δ | Pan – 2.5" (0.7 qt) | 03, 13 | 6 ea |
| 30887 Δ | Pan – 4" (1.0 qt) | 03, 13 | 6 ea |
| 30888 Δ | Pan – 6" (1.4 qt) | 03, 13 | 6 ea |
| 10535 Δ | Drain Shelf | 13 | 6 ea |
| EZ Access Lids – One Ninth Size | | | |
| 10538Z Δ | EZ Access Lid, Unnotched | 13 | 6 ea |
| 10539Z Δ | EZ Access Lid, Single Notched | 13 | 6 ea |
| Lids – Fits All One-Ninth Size Pans | | | |
| 30583 | Smart Lid, Unnotched | 60 | 6 ea |
| 10536U Δ | Flat Lid, Unnotched | 13 | 6 ea |
| 10537U Δ | Flat Lid, Single Notched | 13 | 6 ea |

NSF Listed products are designated with a Δ and may be prefixed with an N
 Note: Capacities are based on liquid measurements to rim, i.e. flush fill

Made specifically for **warming and holding cabinets**, our single- and double-handled pans help **products stay warm and fresh for your customers.**

Specialty High Heat Handled Pans

- Transports food safely from the oven to the warming unit
- Double handled pan is perfect for restaurants with “pass through” warming units
- Stain-, heat- and impact- resistant high heat material
- Available in 2.5" and 4" depths
- NSF Listed; dishwasher safe

High Heat Pan Divider

Pair our high heat pan divider (30871) with our 1/3 size, 2.5" deep handled pans (30860HH and 308614) to warm and hold multiple items in one pan while reducing the risk of foods touching; perfect for low volume meat or chicken items

- Use with 1/6 size drain shelf to help keep foods fresh



Amber(13)

| Prod No | Description | Color | Pack |
|---------------------------------|-----------------------------------|-------|------|
| Specialty High Heat Pans | | | |
| 30860H Δ | 1/3 Size 2.5" Deep with 1 Handle | 13 | 6 ea |
| 30860HH Δ | 1/3 Size 2.5" Deep with 2 Handles | 13 | 6 ea |
| 30861H Δ | 1/3 Size 4" Deep with 1 Handle | 13 | 6 ea |
| 30861HH Δ | 1/3 Size 4" Deep with 2 Handles | 13 | 6 ea |
| 30871 Δ | 1/6 Size 2.5" Deep Pan Divider | 13 | 8 ea |

NSF Listed products are designated with a Δ and may be prefixed with an N



METAL FOOD PANS & LIDS

Food pans are **the back bone of any foodservice operation**. For storing, preparing and serving, they are a necessity. Only Carlisle offers you **complete versatility with a broad range of food pans** to meet your needs.



DuraPan™ Food Pans

Double reinforced corners and unique impact resistant edge design help pans hold shape; will not jam together during storage. Tapered pans fit standard food pan templates and will stack or nest with most other leading brands. Versatile 18-8 stainless pans go from freezer to oven to serving line; ideal for cook-chill operations.

Steam Table Application

DuraPan's impact resistant edge maintains shape better and lays flat, providing a tight seal for better temperature retention in steam tables

DuraPan Covers

- Made of heavy gauge 18-8 stainless steel
- Available in solid or slotted styles
- Recessed handles offer a secure grip
- Notched lids allow easy access for serving spoons



Coldmaster® Application

Use DuraPans with Coldmaster Coldpans (shown on page 113) to keep foods cold without ice or electricity



Full Shoulders
Prevent jamming during storage and provide added strength for longer life

Spoonable Bottoms
Add structural rigidity; allows easy access to food and makes clean up easier

DuraPans Covers, Recessed Handles
Large, recessed handles offer a secure grip. Notched lids allow easy access with serving spoons

Double Reinforced Corners
With unique impact resistant edge design holds shape even under the toughest conditions

Drain Grates

- Chrome-plated, heavy-duty grates with durable welded construction holds food above pan
- Use for cooling or draining foods
- Fits full size pans



Divided DuraPans

- Divided pan is perfect for serving complimentary foods
- Single pan fits in full size pan opening; eliminates the need for adapter bars



Divided Pan with PC140N Cateraide™ Top Loader

Available in heavy gauge or light gauge, Carlisle offers a wide range of accessories including solid and slotted covers, drain shelves, divided pans and adapter bars.

| Prod No | Description | Pack |
|---|---------------------------------------|------|
| Light Gauge | | |
| Full-Size – 20.75" x 12.75" | | |
| 607001 Δ | Pan – 1" (4.2 qt) | 6 ea |
| 607002 Δ | Pan – 2.5" (10.4 qt) | 6 ea |
| 607004 Δ | Pan – 4" (16.6 qt) | 6 ea |
| 607006 Δ | Pan – 6" (24.9 qt) | 6 ea |
| 607002P Δ | Perforated Pan – 2.5" | 6 ea |
| 607004P Δ | Perforated Pan – 4" | 6 ea |
| 607006P Δ | Perforated Pan – 6" | 6 ea |
| 607000C Δ | Solid Cover | 6 ea |
| 607000CS | Slotted Cover | 6 ea |
| 607000H | Hinged Flat Cover with Handles | 6 ea |
| 607002D Δ | Full-Size Divided Pan 2.5" Deep | 6 ea |
| 602202 | Drain Grate - Fits Full-Size Food Pan | 6 ea |
| Two-Thirds Size – 13.88" x 12.75" | | |
| 607232 Δ | Pan – 2.5" (6.8 qt) | 6 ea |
| 607236 Δ | Pan – 6" (16.2 qt) | 6 ea |
| 607230C Δ | Solid Cover | 6 ea |
| One-Half Size – 12.75" x 10.38" | | |
| 607122 Δ | Pan – 2.5" (0.9 qt) | 6 ea |
| 607124 Δ | Pan – 4" (1.4 qt) | 6 ea |
| 607126 Δ | Pan – 6" (2.1 qt) | 6 ea |
| 607122P Δ | Perforated Pan – 2.5" | 6 ea |
| 607124P Δ | Perforated Pan – 4" | 6 ea |
| 607120C Δ | Solid Cover | 6 ea |
| 607120CS | Slotted Cover | 6 ea |
| 602203 | Drain Grate - Fits Half-Size Food Pan | 6 ea |
| One-Half Long Size – 20.5" x 6.38" | | |
| 60700HL2 Δ | Pan – 2.5" (5.2 qt) | 6 ea |
| 60700HL4 Δ | Pan – 4" (8.3 qt) | 6 ea |
| 60700HL6 Δ | Pan – 6" (12.5 qt) | 6 ea |
| 60700HLC Δ | Solid Cover | 6 ea |
| One-Third Size – 12.75" x 6.88" | | |
| 607132 Δ | Pan – 2.5" (3.4 qt) | 6 ea |
| 607134 Δ | Pan – 4" (5.4 qt) | 6 ea |
| 607136 Δ | Pan – 6" (8.1 qt) | 6 ea |
| 607130C Δ | Solid Cover | 6 ea |
| 607130CS | Slotted Cover | 6 ea |
| One-Quarter Size – 10.38" x 6.38" | | |
| 607142 Δ | Pan – 2.5" (2.6 qt) | 6 ea |
| 607144 Δ | Pan – 4" (4.2 qt) | 6 ea |
| 607146 Δ | Pan – 6" (6.2 qt) | 6 ea |
| 607140C Δ | Solid Cover | 6 ea |
| 607140CS | Slotted Cover | 6 ea |
| One-Sixth Size – 6.88" x 6.25" | | |
| 607162 Δ | Pan – 2.5" (1.6 qt) | 6 ea |
| 607164 Δ | Pan – 4" (2.6 qt) | 6 ea |
| 607166 Δ | Pan – 6" (3.9 qt) | 6 ea |
| 607160C Δ | Solid Cover | 6 ea |
| 607160CS | Slotted Cover | 6 ea |
| One-Ninth Size – 6.88" x 4.25" | | |
| 607192 Δ | Pan – 2.5" (1.0 qt) | 6 ea |
| 607194 Δ | Pan – 4" (1.7 qt) | 6 ea |
| 607190C Δ | Solid Cover | 6 ea |
| 607190CS | Slotted Cover | 6 ea |

| Prod No | Description | Pack |
|--|----------------------|------|
| Heavy Gauge | | |
| Full-Size – 20.75" x 12.75" | | |
| 608002 Δ | Pan – 2.5" (10.4 qt) | 6 ea |
| 608004 Δ | Pan – 4" (16.6 qt) | 6 ea |
| 608006 Δ | Pan – 6" (24.9 qt) | 6 ea |
| Two-Thirds Size – 13.88" x 12.75" | | |
| 608236 Δ | Pan – 6" (16.2 qt) | 6 ea |
| One-Half Size – 12.75" x 10.38" | | |
| 608122 Δ | Pan – 2.5" (0.9 qt) | 6 ea |
| 608124 Δ | Pan – 4" (1.4 qt) | 6 ea |
| 608126 Δ | Pan – 6" (2.1 qt) | 6 ea |
| One-Third Size – 12.75" x 6.88" | | |
| 608132 Δ | Pan – 2.5" (3.4 qt) | 6 ea |
| 608134 Δ | Pan – 4" (5.4 qt) | 6 ea |
| 608136 Δ | Pan – 6" (8.1 qt) | 6 ea |
| One-Quarter Size – 10.38" x 6.38" | | |
| 608142 Δ | Pan – 2.5" (2.6 qt) | 6 ea |
| 608144 Δ | Pan – 4" (4.2 qt) | 6 ea |
| 608146 Δ | Pan – 6" (6.2 qt) | 6 ea |
| One-Sixth Size – 6.88" x 6.25" | | |
| 608162 Δ | Pan – 2.5" (1.6 qt) | 6 ea |
| 608164 Δ | Pan – 4" (2.6 qt) | 6 ea |
| 608166 Δ | Pan – 6" (3.9 qt) | 6 ea |
| One-Ninth Size – 6.88" x 4.25" | | |
| 608192 Δ | Pan – 2.5" (1.0 qt) | 6 ea |
| 608194 Δ | Pan – 4" (1.7 qt) | 6 ea |

Adapter Bars

- Use adapter bars with in steam table applications, CATERAIDES or other standard transport containers
- Two sizes available to work with full or fractional size pans



| Prod No | Description | Pack |
|---------------------|--------------------|-------|
| Adapter Bars | | |
| 6070A Δ | 20.5" Adapter Bar | 12 ea |
| 6071A Δ | 12.75" Adapter Bar | 12 ea |

NSF Listed products are designated with a Δ and may be prefixed with an N
Note: Capacities are based on liquid measurements to rim, i.e. flush fill



STORPLUS™ STORAGE BOXES

StorPlus **color-coded** storage boxes are a solution that helps employees **easily identify** proper storage containers, **eliminating cross-contamination**.

Benefits of StorPlus Color-Coded Storage Boxes

- Prevent cross-contamination and help meet standards as part of a complete HACCP Program
- RimGlow™ technology gives the boxes and lids a distinct, yet transparent color to segregate them by usage

StorPlus Color-Coded Storage Boxes & Lids

Food Storage Boxes

- Reinforced top and bottom corners on both box and lid, help prevent chipping and cracking
- Quart, gallon and liter capacity indicators (on 12" x 18" box)
- StorPlus boxes stack easily for efficient storage, fit standard carts and racks and with other boxes on the market
- Smooth interior surface makes cleaning easy
- "Lock-Tight" lids can be reversed and used as bun pan or tray
- Polycarbonate boxes provide easy visibility, superior resistance to food acids and oils and withstands temperatures from -40°F to 212°F
- Boxes double as dough proofing bus boxes, warewashing tubs for kitchen overflow or remote locations
- 18" x 26" colander is ideal for storing, draining, thawing and marinating foods; keeps lettuce crisp, thaws and drains fish on ice, marinates chicken, etc.
- Polyethylene boxes offers economical storage and transport and withstands temperatures from -40°F to 180°F
- NSF Listed; dishwasher safe

ServSafe® Recommended Stacking Order:



Allergen Control

Cooked/Dry Foods and Dairy

Fruits/Vegetables

Meats

Fish/Seafood

Poultry

ServSafe® is a registered trademark of the National Restaurant Association



| White(02) | Red(05) | Clear(07) | Green(09) | Blue(14) | Yellow(22) | Purple(89) |
|-----------------------------|---------|----------------------------------|--------------------|------------------------------|------------|------------|
| Prod No | Color | Prod No | Color | Description | Pack | |
| Clear Polycarbonate* | | Color-Coded Polycarbonate | | | | |
| 10610 Δ ♦ | 07 | | | 2 gal 12" x 18" x 3.5 Box | 6 ea | |
| 10611 Δ ♦ | 07 | 10611C Δ ♦ | 05, 09, 14, 22 | 3.5 gal 12" x 18" x 6" Box | 6 ea | |
| 10612 Δ ♦ | 07 | 10612C Δ ♦ | 05, 09, 14, 22 | 5 gal 12" x 18" x 9" Box | 6 ea | |
| 10617 Δ ♦ | 07 | 10617C Δ ♦ | 05, 09, 14, 22 | 12" x 18" Lid | 6 ea | |
| 10620 Δ ♦ | 07 | — | | 5 gal 18" x 26" x 3.5" Box | 6 ea | |
| 10621 Δ ♦ | 07 | 10621C Δ ♦ | 05, 09, 14, 22, 89 | 8.5 gal 18" x 26" x 6" Box | 6 ea | |
| 10622 Δ ♦ | 07 | 10622C Δ ♦ | 05, 09, 14, 22, 89 | 12.5 gal 18" x 26" x 9" Box | 4 ea | |
| 10623 Δ ♦ | 07 | 10623C Δ ♦ | 05, 09, 14, 22 | 16.6 gal 18" x 26" x 12" Box | 3 ea | |
| 10624 Δ ♦ | 07 | 10624C Δ ♦ | 05, 09, 14, 22 | 21.5 gal 18" x 26" x 15" Box | 3 ea | |
| 10627 Δ ♦ | 07 | 10627C Δ ♦ | 05, 09, 14, 22, 89 | 18" x 26" Lid | 6 ea | |
| 10628 Δ ♦ | 07 | — | | 18" x 26" x 5" Colander | 6 ea | |
| 10629 Δ ♦ | 07 | — | | 18" x 26" Drain Grate | 6 ea | |

NSF Listed products are designated with a Δ and may be prefixed with an N
Clear polycarbonate food boxes comes in Clear(07) only

♦ California Residents: Bisphenol A **WARNING:** See appendix A on page 1



White(02)

| Prod No | Description | Color | Pack |
|---------------------------|------------------------------|-------|------|
| White Polyethylene | | | |
| 10630 Δ | 2 gal 12" x 18" x 3.5" Box | 02 | 6 ea |
| 10631 Δ | 3.5 gal 12" x 18" x 6" Box | 02 | 6 ea |
| 10632 Δ | 5 gal 12" x 18" x 9" Box | 02 | 6 ea |
| 10637 Δ | 12" x 18" "Lock-Tight" Lid | 02 | 6 ea |
| 10640 Δ | 5 gal 18" x 26" x 3.5" Box | 02 | 6 ea |
| 10641 Δ | 8.5 gal 18" x 26" x 6" Box | 02 | 6 ea |
| 10642 Δ | 12.5 gal 18" x 26" x 9" Box | 02 | 4 ea |
| 10643 Δ | 16.6 gal 18" x 26" x 12" Box | 02 | 3 ea |
| 10644 Δ | 21.5 gal 18" x 26" x 15" Box | 02 | 3 ea |
| 10647 Δ | 18" x 26" "Lock-Tight" Lid | 02 | 6 ea |
| 10648 Δ | 18" x 26" x 5" Colander | 02 | 6 ea |

NSF Listed products are designated with a Δ and may be prefixed with an N



STORPLUS™ STORAGE CONTAINERS

StorPlus storage containers are clear and have **tight fitting lids**, improving organization and **minimizing the risk** of cross contamination, **making work easier**.

Square Food Storage Containers

- Perfect for storing condiments, spices, toppings, leftover or preparation
- Stacking lugs add rigidity and eliminate jamming
- Stackable with other popular brands; compatible lids fit competitors' food storage containers
- Wide handles and drain holes available on all sizes for easy-grip and quick drying
- Writing surface available to record dates and reduce food waste
- Color-coded, textured snap-on lids fit both the polycarbonate and polyethylene containers
- Smooth interior finish with spoonable bottom helps prevent food waste and makes clean-up easy
- Clear polycarbonate containers provide exceptional durability and can withstand temperatures from -40°F to 212°F
- Economical white polyethylene containers withstand temperatures from -40°F to 180°F
- NSF Listed; dishwasher safe



Safe & Easy Lifting

Carlisle offers square storage containers in 2qt to 22qt with handles on both sides

Cross Compatible

Carlisle StorPlus lids fit and stack with key competitors' food storage containers

| | | | | | | |
|-----------|---------|-----------|------------------|----------|------------|--------------|
| White(02) | Red(05) | Clear(07) | Forest Green(08) | Blue(60) | Purple(89) | Purple(AF07) |
|-----------|---------|-----------|------------------|----------|------------|--------------|

| Prod No | Description | Color | Pack |
|--|---|----------|------|
| StorPlus Square Polycarbonate Food Storage Containers | | | |
| 10720 Δ ♦ | 2 qt, 7.13" Sq x 3.81" H Polycarbonate Container | 07, AF07 | 6 ea |
| 10721 Δ ♦ | 4 qt, 7.13" Sq x 7.31" H Polycarbonate Container | 07, AF07 | 6 ea |
| 10722 Δ ♦ | 6 qt, 8.75" Sq x 7.31" H Polycarbonate Container | 07, AF07 | 6 ea |
| 10723 Δ ♦ | 8 qt, 8.75" Sq x 9" H Polycarbonate Container | 07, AF07 | 6 ea |
| 10724 Δ ♦ | 12 qt, 11.13" Sq x 8.25" H Polycarbonate Container | 07, AF07 | 6 ea |
| 10725 Δ ♦ | 18 qt, 11.13" Sq x 12.56" H Polycarbonate Container | 07, AF07 | 6 ea |
| 10726 Δ ♦ | 22 qt, 11.13" Sq x 15.75" H Polycarbonate Container | 07, AF07 | 6 ea |
| StorPlus Square Polyethylene Food Storage Containers | | | |
| 10730 Δ | 2 qt, 7.13" Sq x 3.81" H Polyethylene Container | 02 | 6 ea |
| 10731 Δ | 4 qt, 7.13" Sq x 7.31" H Polyethylene Container | 02 | 6 ea |
| 10732 Δ | 6 qt, 8.75" Sq x 7.31" H Polyethylene Container | 02 | 6 ea |
| 10733 Δ | 8 qt, 8.75" Sq x 9" H Polyethylene Container | 02 | 6 ea |
| 10734 Δ | 12 qt, 11.13" Sq x 8.25" H Polyethylene Container | 02 | 6 ea |
| 10735 Δ | 18 qt, 11.13" Sq x 12.56" H Polyethylene Container | 02 | 6 ea |
| 10736 Δ | 22 qt, 11.13" Sq x 15.75" H Polyethylene Container | 02 | 6 ea |
| StorPlus Square Container Lids | | | |
| 10740 Δ | 2-4 qt, 7.31" Sq Lid | 08, 89 | 6 ea |
| 10741 Δ | 6-8 qt, 9" Sq Lid | 05, 89 | 6 ea |
| 10742 Δ | 12-18-22 qt, 11.38" Sq Lid | 60, 89 | 6 ea |

NSF Listed products are designated with a Δ and may be prefixed with an N
 ♦ California Residents: Bisphenol A **WARNING:** See appendix A on page 1

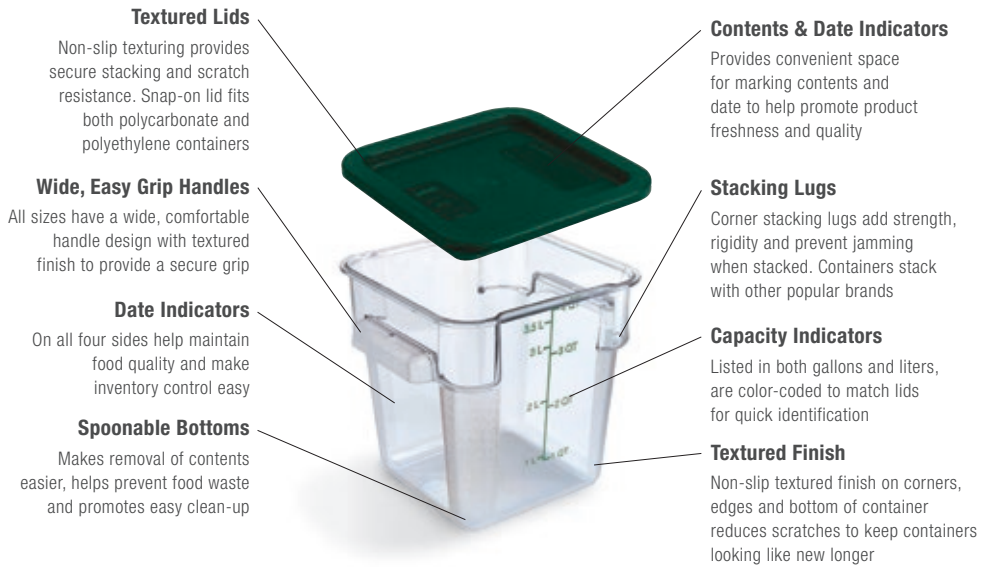

| Prod No | Description | Color - Container/Lid | Pack |
|--|--|-----------------------|------|
| StorPlus 3-Pack Square Containers (Includes Lids) | | | |
| 10720-307 Δ \blacklozenge | 2 qt, 7.13" Sq x 3.81" H Polycarbonate Container | 07 / 08 | 3 ea |
| 10721-307 Δ \blacklozenge | 4 qt, 7.13" Sq x 7.31" H Polycarbonate Container | 07 / 08 | 3 ea |
| 10730-302 Δ | 2 qt, 7.13" Sq x 3.81" H Polyethylene Container | 02 / 08 | 3 ea |
| 10731-302 Δ | 4 qt, 7.13" Sq x 7.31" H Polyethylene Container | 02 / 08 | 3 ea |
| StorPlus 2-Pack Square Containers (Includes Lids) | | | |
| 10722-207 Δ \blacklozenge | 6 qt, 8.75" Sq x 7.31" H Polycarbonate Container | 07 / 05 | 2 ea |
| 10723-207 Δ \blacklozenge | 8 qt, 8.75" Sq x 9" H Polycarbonate Container | 07 / 05 | 2 ea |
| 10732-202 Δ | 6 qt, 8.75" Sq x 7.31" H Polyethylene Container | 02 / 05 | 2 ea |
| 10733-202 Δ | 8 qt, 8.75" Sq x 9" H Polyethylene Container | 02 / 05 | 2 ea |

NSF Listed products are designated with a Δ and may be prefixed with an N
 \blacklozenge California Residents: Bisphenol A **WARNING:** See appendix A on page 1



STORPLUS™ STORAGE CONTAINERS

Economical Space Savers

- Clean, safe alternative to storing food in shipping cartons
- Square shape allows for practical storage in the freezer, cooler or shelf
- Molded-in volume graduations indicate capacity
- Translucent polypropylene offers contact clarity for easy identification of products
- Withstand temperatures from 32°F to 170°F
- Economical white polyethylene withstands temperatures from -40°F to 180°F
- NSF Listed; dishwasher safe



| Prod No | Description | Color | Pack |
|--|--|-------|-------|
| Economical Polypropylene Space Savers | | | |
| ST1532 Δ | 2 qt, 6.62" Sq x 4.12" H Polypropylene Container | 30 | 12 ea |
| ST1544 Δ | 4 qt, 6.62" Sq x 8.12" H Polypropylene Container | 30 | 12 ea |
| ST1556 Δ | 6 qt, 8.60" Sq x 6.87" H Polypropylene Container | 30 | 12 ea |
| ST1568 Δ | 8 qt, 8.60" Sq x 9.25" H Polypropylene Container | 30 | 12 ea |
| ST1629 Δ | 18 qt, 14.18" x 8.31" x 12.75" H Polypropylene Container | 30 | 6 ea |
| Economical Polyethylene Space Savers | | | |
| 1532 Δ | 2 qt, 6.62" Sq x 4.12" H Polyethylene Container | 02 | 12 ea |
| 1544 Δ | 4 qt, 6.62" Sq x 8.12" H Polyethylene Container | 02 | 12 ea |
| 1556 Δ | 6 qt, 8.60" Sq x 8.12" H Polyethylene Container | 02 | 12 ea |
| 1568 Δ | 8 qt, 8.60" Sq x 9.25" H Polyethylene Container | 02 | 12 ea |
| 1629 Δ | 18 qt, 14.18" x 8.31" x 12.75" H Polyethylene Container | 02 | 6 ea |
| Economical Space Saver Lids | | | |
| ST1573 | 2-4 qt, 6.62" Sq Lid | 30 | 12 ea |
| ST1587 | 6-8 qt, 8.60" Sq Lid | 30 | 12 ea |
| ST1630 | 18 qt, 14.37" Sq Lid | 30 | 6 ea |

NSF Listed products are designated with a Δ and may be prefixed with an N

Round Food Storage Containers

- Super-tough, clear polycarbonate for ultimate durability allows easy food content identification at a glance
- StorPlus containers stack with other major brands for convenient storage; stacking shoulder prevents jamming
- Date indicator helps maintain food quality and control inventory turns, interchangeable with other brands
- Exclusive Carlisle spoonable bottom for increased yield and less food waste
- Clear polycarbonate containers can withstand temperatures from -40°F to 212°F
- NSF Listed; dishwasher safe



| Prod No | Description | Color | Pack |
|---|-----------------------|-------|-------|
| StorPlus Round Food Storage Containers | | | |
| 10761 Δ ♦ | 1 qt Round Container | 07 | 12 ea |
| 10763 Δ ♦ | 2 qt Round Container | 07 | 12 ea |
| 10764 Δ ♦ | 4 qt Round Container | 07 | 12 ea |
| 10765 Δ ♦ | 6 qt Round Container | 07 | 12 ea |
| 10766 Δ ♦ | 8 qt Round Container | 07 | 12 ea |
| 10767 Δ ♦ | 12 qt Round Container | 07 | 6 ea |
| 10768 Δ ♦ | 18 qt Round Container | 07 | 6 ea |
| 10769 Δ ♦ | 22 qt Round Container | 07 | 6 ea |
| StorPlus Round Container Lids | | | |
| 10770 Δ ♦ | 1 qt Round Lid | 30 | 12 ea |
| 10771 Δ ♦ | 2-4 qt Round Lid | 08 | 12 ea |
| 10772 Δ ♦ | 6-8 qt Round Lid | 05 | 12 ea |
| 10773 Δ ♦ | 12-18-22 qt Round Lid | 60 | 6 ea |

NSF Listed products are designated with a Δ and may be prefixed with an N
 ♦ California Residents: Bisphenol A **WARNING:** See appendix A on page 1



STORPLUS™ STORAGE CONTAINERS

Bains Marie

- Carlisle Bains Marie are the original round food storage containers
- Outside stacking lugs prevent jamming
- 12, 18, & 22 qt sizes have recessed handles for extra strength and stability in lifting, as well as graduated U.S. measurements shown on the side of the container
- 2, 3.5, 6, & 8 qt sizes can be imprinted
- Clear polypropylene containers are translucent and seamless, offering contact clarity for easy identification of products
- Polypropylene containers withstand temperatures from 32°F to 170°F
- Economical white polyethylene containers will withstand temperatures from -40°F to 180°F
- NSF Listed; dishwasher safe



| Prod No | Description | Color | Pack |
|---|--|-------|-------|
| Bains Marie Polypropylene Containers | | | |
| 0205 Δ | 2 qt Container, 6.56" D x 4.38" H | 30 | 12 ea |
| 0355 Δ | 3.5 qt Container, 6.56" D x 7.63" H | 30 | 12 ea |
| 0605 Δ | 6 qt Container, 7.63" D x 8.13" H | 30 | 12 ea |
| 0805 Δ | 8 qt Container, 7.63" D x 10.75" H | 30 | 12 ea |
| 1205 Δ | 12 qt Container, 12.25" D x 8.75" H | 30 | 6 ea |
| 1805 Δ | 18 qt Container, 12.38" D x 13" H | 30 | 6 ea |
| 2205 Δ | 22 qt Container, 12.25" D x 15.44" H | 30 | 6 ea |
| Bains Marie Polypropylene Container Lids | | | |
| 0202 Δ | 2 – 3.5 qt Lid, 6.69" D x .31" H | 30 | 12 ea |
| 0602 Δ | 6 – 8 qt Lid, 8.06" D x .38" H | 30 | 12 ea |
| 1252 Δ | 12 – 18 – 22 qt Lid, 12.38" D x .75" H | 30 | 6 ea |
| Bains Marie Polyethylene Containers | | | |
| 0200 Δ | 2 qt Container, 6.56" D x 4.44" H | 02 | 12 ea |
| 0350 Δ | 3.5 qt Container, 6.56" D x 7.63" H | 02 | 12 ea |
| 0600 Δ | 6 qt Container, 7.63" D x 8.13" H | 02 | 12 ea |
| 0800 Δ | 8 qt Container, 7.625" D x 10.75" H | 02 | 12 ea |
| 1200 Δ | 12 qt Container, 12.25" D x 8.75" H | 02 | 6 ea |
| 1800 Δ | 18 qt Container, 12.38" D x 13" H | 02 | 6 ea |
| 2200 Δ | 22 qt Container, 12.25" D x 15.44" H | 02 | 6 ea |
| Bains Marie Polyethylene Container Lids | | | |
| 0203 Δ | 2 – 3.5 qt Lid, 6.69" D | 02 | 12 ea |
| 0603 Δ | 6 – 8 qt Lid, 8.63" D | 02 | 12 ea |
| 1202 Δ | 12 – 18 – 22 qt Lid, 12.38" D | 02 | 6 ea |

NSF Listed products are designated with a Δ and may be prefixed with an N



Ingredient Bins

- Portable, convenient storage bins for large quantities of sugar, flour, etc.
- Lids slide open for easy access
- Heavy-duty, non-marking casters
- Replacement Parts for BIN27, BIN36, & BIN44 shown in chart below



Floor Rack System

- Interlocking modular system provides a raised surface in dry and cooling storage areas
- Perfect for areas where moisture collects on the floor
- Open design allows for air circulation
- 12" square units lock together, holds up to 3,000 pounds per square foot
- Made of FDA approved high density polyethylene, withstands temperatures from -40°F to 180°F
- NSF Listed; dishwasher safe or clean with hose



| Prod No | Description | Color | Pack |
|------------------------|---|-------|-------|
| Ingredient Bins | | | |
| BIN27 | 27 gal Capacity Bin, 28.5"L x 12.69"W x 27.88"H | 02 | 1 ea |
| BIN36 | 36 gal Capacity Bin, 29.5"L x 15.38"W x 28.25"H | 02 | 1 ea |
| BIN44 | 44 gal Capacity Bin, 29.5"L x 18.13"W x 29"H | 02 | 1 ea |
| BIN27L | Replacement lid for BIN27 | 02 | 1 ea |
| BIN36L | Replacement lid for BIN36 | 02 | 1 ea |
| BIN44L | Replacement lid for BIN44 | 02 | 1 ea |
| Floor Rack | | | |
| 2710 Δ | 12" x 12" x 1.5" Floor Rack | 23 | 12 ea |

NSF Listed products are designated with a Δ and may be prefixed with an N



CARLISLE
FOODSERVICE PRODUCTS

EFFICIENT
DURABLE
INNOVATIVE
SMART
**WARE-
WASHING
PRODUCTS**

Carlisle offers every rack, basket and accessory you need for efficient warewashing operations. OptiClean™ is the industry standard for enabling clean, spotless ware. Our full line of color-coded rack extenders and Plaque-a-Racks are the ideal solution for sorting and managing your ware.





OPTICLEAN™

Engineered to Flow

Warewashing can be labor intensive. If not well managed, it is likely to hurt your operation's bottom line and add unnecessary frustration. However, labor and efficiency is not the operator's only problem. The quality of your warewashing could directly affect your customers' health and the reputation of your establishment. If an effective system of cleaning and sanitation is not upheld, you may be facing risks on a daily basis that could jeopardize the future of your business.



3-Component System

Base Rack // Open Extender // Divided Extender

By alternating open and divided extenders, each level of the rack offers efficient flow through of water for superior performance and thick divided walls for protection



Double-wall Construction

Maximum strength, protects contents from moving machine parts



Versatile Stacking

Stacking from either direction and with all major competitors



Open Wall Design

Open profile facilitates superior washing, complete rinsing and fast drying



Quick Draining

No flat surfaces to trap water or loose food particles within the rack—ensuring rapid drying



4-way Tracking

Easy dish machine loading from any side without the need to rotate racks



Locking Extenders

Unique snap-on design allows for fast, simple assembly



Comfort Curve Handles

Comfort Curve Handles—molded into all four sides for easy handling, won't pinch fingers

All OptiClean Racks have an outside measurement of 19.75" x 19.75"

The Honeycomb

We've developed the most highly engineered warewashing solutions to improve your establishment's operational efficiency. Carlisle utilizes a tested geometric honeycomb structure, admired and studied since ancient times. The honeycomb design delivers unmatched durability while simultaneously increasing the flow of water through each rack. The open honeycomb design also eliminates flat surfaces and corners that would otherwise harbor food particles allowing water to drain and contents to dry quickly.

NeWave™

In pursuit of an even more efficient foodservice operation, we developed the OptiClean NeWave glass rack. These rounded wave design racks hold 20% more glasses than equivalent, square-compartment racks. This means more glasses in less racks, reduced chemical and/or water usage and improved labor efficiency. NeWave also holds glasses securely in place, resulting in minimal movement and reduced breakage.

Easy Identification

Water is not the only aspect we engineered to flow. A color-coded system allows operators to choose their own method of identification to categorize by the type of glass, location of wares within the facility or even specific types of events. This color-coded system allows your operation to flow smoothly and eliminate unnecessary confusion for both existing and new employees.



Textured Finish

Non-slip textured finish on outside walls reduces scratches to keep racks looking new, improve durability and provide a secure grip



6 Extender Colors



NSF Listed

How To Create The Correct Item Number For Your Washrack

1 Each item begins with an **R** for rack

2 Second digit indicates type

- G // Glass
- W // NeWave
- C // Cup
- P // Peg/Plate*
- B // Bowl*
- F // Flatware*
- SP // Sheet Pan*
- FP // Food Pan*
- PC // Plate Cover*
- TP // Tall Peg*
- OP // Open Peg*

*Skip to Step Six

Only available in Blue(14)

3 Glass, NeWave (only 20 or 30) & Cup (only 16 or 20) racks have additional digits beginning with number of compartments

- 9 // Nine Compartment
- 16 // Sixteen Compartment
- 20 // Twenty Compartment
- 25** // Twenty-five Compartment
- 30 // Thirty Compartment
- 36 // Thirty-six Compartment
- 49 // Forty-nine Compartment

4 To add extenders, add a dash and the # of extenders*

- 1 // One Extender
- 2 // Two Extenders
- 3** // Three Extenders
- 4 // Four Extenders
- 5 // Five Extenders

* RW racks have a standard integrated extender, therefore an additional extender for each line listed above e.g. RW20-1 includes two extenders.

5 If you want color-coded extenders, add a **C** – Otherwise, skip this step

6 Lastly, add the color-code

- 410** // Red/Blue
- 411 // Yellow/Blue
- 412 // Orange/Blue
- 413 // Green/Blue
- 414 // Lavender/Blue
- 14 // Blue

7 This order is for a glass rack with 25 compartments, 3 extenders and the top extender is red.

RG25-3C410

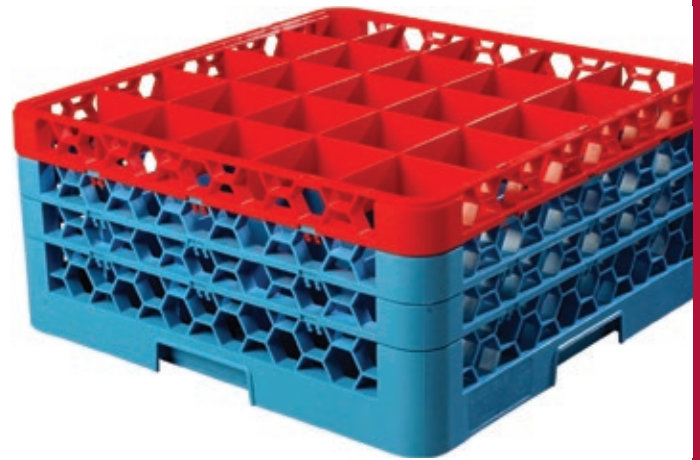

Extender Heights

| | |
|-------------|---------|
| No Extender | 3-1/8" |
| 1 Extender | 4-5/8" |
| 2 Extenders | 6-1/8" |
| 3 Extenders | 7-5/8" |
| 4 Extenders | 9-1/8" |
| 5 Extenders | 10-5/8" |

- Extenders are available in multiple colors including Blue(14), Yellow(04), Red(05), Green(09), Orange(24), Lavender(89)
- Additional accessories can be found at the web address below

Washrack Sizing

| Rack # | Description | Min Dia | Max Dia | Min Dia | Max Dia | Dia for Handles |
|-------------------|--|---------|---------|---------|---------|-----------------|
| Standard | | | | | | |
| RG49 | 49 Compartment Glass Rack | 2" | 2-3/8" | 51 mm | 60 mm | 2-7/8" |
| RG36 | 36 Compartment Glass Rack | 2-3/8" | 2-3/4" | 60 mm | 70 mm | 3-5/8" |
| RG25 | 25 Compartment Glass Rack | 2-3/4" | 3-3/8" | 70 mm | 86 mm | 4-3/8" |
| RG16 | 16 Compartment Glass Rack | 3-3/8" | 4-3/8" | 86 mm | 111 mm | 5-5/8" |
| RG9 | 9 Compartment Glass Rack | 4-3/8" | 5-7/8" | 111 mm | 149 mm | 7-3/4" |
| NeWave | | | | | | |
| RW30 | Glass Rack w/ Integrated Extender 30 Compartment | 2-5/8" | 3" | 67 mm | 76 mm | |
| RW20 | Glass Rack w/ Integrated Extender 20 Compartment | 3" | 3-3/4" | 76 mm | 95 mm | |
| Tilted Cup | | | | | | |
| RC20 | Tilted Cup Rack 20 Compartment | 2-5/8" | 4-1/4" | 67 mm | 108 mm | 5-1/8" |
| RC16 | Tilted Cup Rack 16 Compartment | 4-1/4" | 4-3/8" | 108 mm | 111 mm | 6-5/8" |

Find The Perfect Glass Rack
www.carlislefsp.com/FINDRACK



NEW Customization

Hot Stamping

MOQ

150 eaches per customized rack
(must divide into case pack quantities)

Lead Time

3-4 weeks from receiving PO

Pricing

All pricing is calculated on net customer pricing plus a per piece charge

Per piece charge for hot stamp is net \$0.75/side

Set Up Charge

\$80 per stamp design

Only 3 sides available for inserts for NSF rated products

Artwork for hot stamp:

Digital artwork is required for all custom warewash products. Camera-ready art is defined as digital files in vector format. The preferred format includes Illustrator, Illustrator EPS or InDesign. PNG files (with a transparent background) may be submitted but must be a minimum of 300dpi at 100% of reproduction size. Decorating is limited to one color. Black or white imprint is standard stocked colors, contact Customer Service for a complete list of available imprint colors.

Size dimensions of artwork

3.5" x 1" tall

Sample

Digital sample to be provided

Inserts or stamps will be ordered with signed and approved artwork

Lead time for digital sample: 1-2 days (after receiving sufficient logo file)

No Returns



NEW Customization

Color-Coded Base Racks

MOQ

300 eaches per customized rack
(must divide into case pack quantities)

Lead Time

3-4 weeks from receiving PO

Pricing

All pricing is calculated on net customer pricing plus a per piece charge

Per piece charge for custom colors is net \$1.30/rack

Colors Available

-  Red
-  Yellow
-  Orange
-  Green
-  Purple

Base Racks Available

| | | | |
|------|------|-----|------|
| RW20 | RG16 | RP | RC16 |
| RW30 | RG25 | RTP | RC20 |
| RG9 | RG36 | RB | |
| | RG49 | RF | |

No Returns

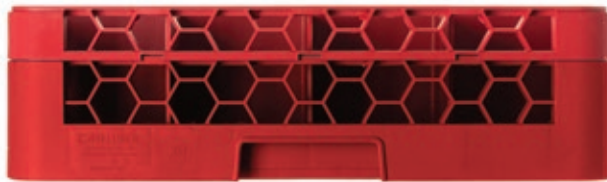

Inserts

MOQ

150 eaches per customized rack
(must divide into case pack quantities)

Lead Time

3-4 weeks from receiving PO

Pricing

All pricing is calculated on net customer pricing plus a per piece charge

Per piece charge for custom insert is net \$0.40/side

Set Up Charge

Inserts - \$1,000/side

Only 3 sides available for inserts for NSF rated products

Artwork for inserts:

Digital artwork is required for all custom warewash products. Camera-ready art is defined as digital files in vector format. The preferred format includes Illustrator, Illustrator EPS or InDesign. PNG files (with a transparent background) may be submitted but must be a minimum of 300dpi at 100% of reproduction size.

Size dimensions of artwork

3.5" x 1" tall

No Returns





OPTICLEAN®

Color-Coded Glass Racks

- OptiClean Glass Racks with Color-Coded Extenders make it easy to identify glass rack size or match specific glassware with a specific rack simply by color
- Carlisle's OptiClean system includes a full range of glass racks designed to meet your needs
- Full dividers in the base offer complete protection for delicate rims
- NSF Listed



Available Colors & Combinations

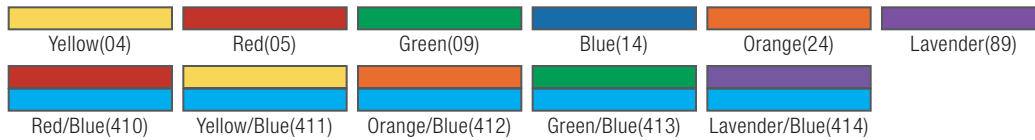

New Color-Coded Options

Engineered to Flow

If your operation has multiple drinkware styles that need to be washed, stored and easily identified, Carlisle has a solution to make work easier. Our OptiClean extenders are available in six color choices. Use this option to color-code your glass racks and keep each piece of drinkware in its proper place. If you have multiple areas of serving within your establishment you can designate specific colors so that your fine dining stemware stays separate from the poolside drinkware.

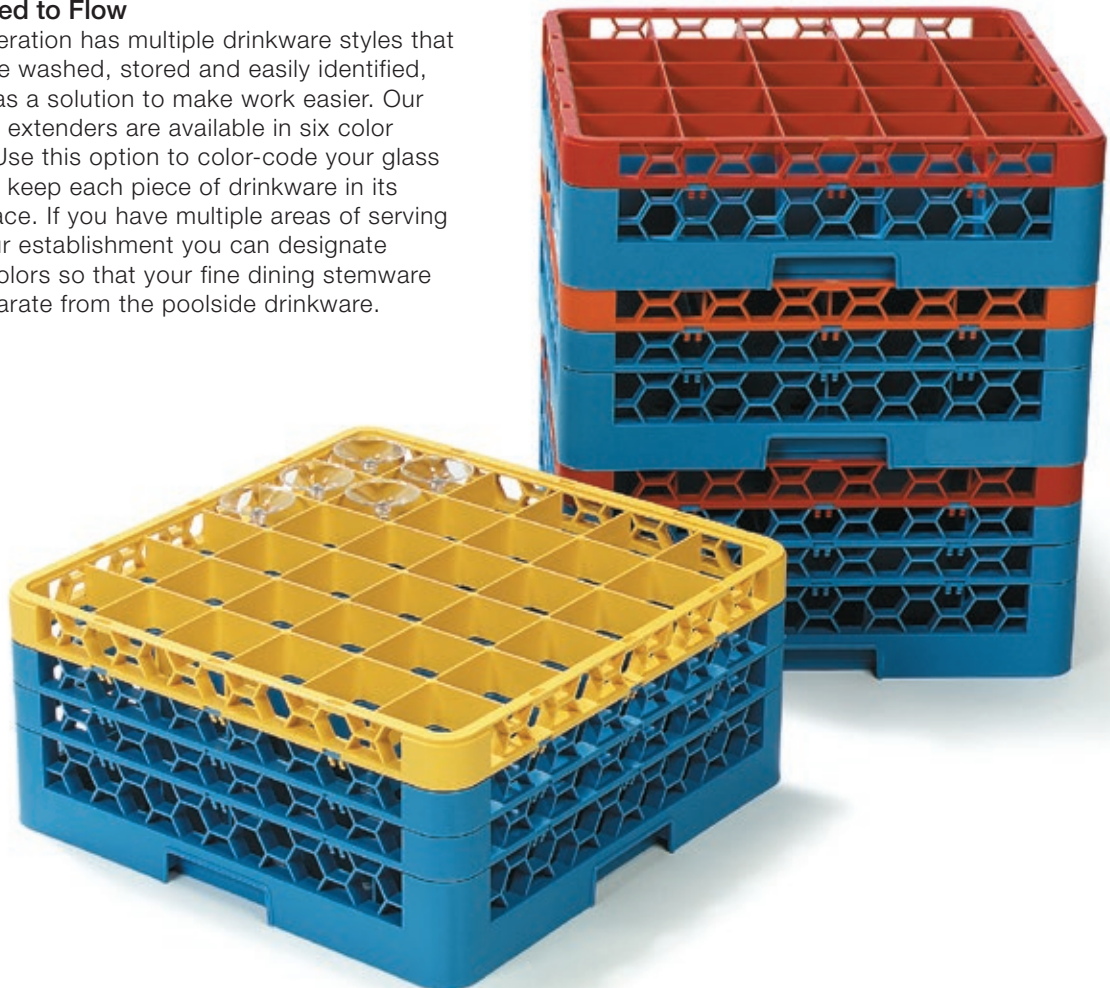

OptiClean NeWave Color-Coded Glass Racks

- Fits 25% more glasses which saves on chemical cost by washing more glasses per cycle
- Honeycomb design allows a free flow of soap and water and balanced weight dispersion when racks are stacked high
- Compatible stacking with standard dish racks ensuring a smooth transition to Carlisle washracks without interrupting workflow
- Color coded extenders allow for convenient identification
- Most durable rack in the market
- NSF Listed



NeWave 20-Compartment

- Use for glasses & tumblers

NeWave 30-Compartment

- Use for glasses & tumblers

Get more clean glasses per wash cycle. Check out the measurement chart on page 237 to find the most efficient wash rack for your glass size.



RW20



RW30-2

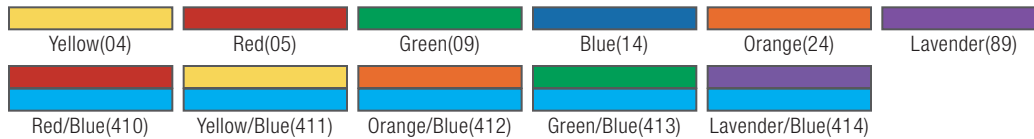

| Prod No | Description | Glass Dia* | Glass Height | Color | Pack |
|--|---|------------|--------------|-------------------------|------|
| 20-Compartment NeWave Glass Rack - Compartment Size 3.81" Dia | | | | | |
| RW20 Δ | 20-Compartment with Integrated Extender | 3.56" | 4.75" | 14 | 4 ea |
| RW20-1 Δ | 20-Compartment with 2 Extenders | 3.56" | 6.34" | 14 | 3 ea |
| RW20-2 Δ | 20-Compartment with 3 Extenders | 3.56" | 7.94" | 14 | 2 ea |
| RW20-3 Δ | 20-Compartment with 4 Extenders | 3.56" | 9.5" | 14 | 2 ea |
| REW20S | 20-Compartment Extender | 3.56" | 1.5" | 14 | 6 ea |
| 20-Compartment Color-Coded NeWave Glass Rack—Compartment Size 3.81" Dia | | | | | |
| REW20SC | 20-Compartment Divided Extender | 3.56" | 1.5" | 04, 05, 09, 24, 89 | 6 ea |
| RW20-C Δ | 20-Compartment with Integrated Extender | 3.56" | 4.75" | 410, 411, 412, 413, 414 | 4 ea |
| RW20-1C Δ | 20-Compartment with 2 Extenders | 3.56" | 6.34" | 410, 411, 412, 413, 414 | 3 ea |
| RW20-2C Δ | 20-Compartment with 3 Extenders | 3.56" | 7.94" | 410, 411, 412, 413, 414 | 2 ea |
| RW20-3C Δ | 20-Compartment with 4 Extenders | 3.56" | 9.5" | 410, 411, 412, 413, 414 | 2 ea |
| RW20-4C Δ | 20-Compartment with 5 Extenders | 3.56" | 11.1" | 410, 411, 412, 413, 414 | 1 ea |
| 30-Compartment NeWave Glass Rack - Compartment Size 3.13" Dia | | | | | |
| RW30 Δ | 30-Compartment with Integrated Extender | 2.88" | 4.75" | 14 | 4 ea |
| RW30-1 Δ | 30-Compartment with 2 Extenders | 2.88" | 6.34" | 14 | 3 ea |
| RW30-2 Δ | 30-Compartment with 3 Extenders | 2.88" | 7.94" | 14 | 2 ea |
| RW30-3 Δ | 30-Compartment with 4 Extenders | 2.88" | 9.5" | 14 | 2 ea |
| REW30S | 30-Compartment Extender | 2.88" | 1.5" | 14 | 6 ea |
| 30-Compartment Color-Coded NeWave Glass Rack—Compartment Size 3.13" Dia | | | | | |
| REW30SC | 30-Compartment Divided Extender | 3.56" | 1.5" | 04, 05, 09, 24, 89 | 6 ea |
| RW30-C Δ | 30-Compartment with Integrated Extender | 2.88" | 4.75" | 410, 411, 412, 413, 414 | 4 ea |
| RW30-1C Δ | 30-Compartment with 2 Extenders | 2.88" | 6.34" | 410, 411, 412, 413, 414 | 3 ea |
| RW30-2C Δ | 30-Compartment with 3 Extenders | 2.88" | 7.94" | 410, 411, 412, 413, 414 | 2 ea |
| RW30-3C Δ | 30-Compartment with 4 Extenders | 2.88" | 9.5" | 410, 411, 412, 413, 414 | 2 ea |
| RW30-4C Δ | 30-Compartment with 5 Extenders | 2.88" | 11.1" | 410, 411, 412, 413, 414 | 1 ea |

NSF Listed products are designated with a Δ and may be prefixed with an N

*Dimensions shown are for the recommended maximum glass size for the compartment



OPTICLEAN®

9-Compartment

- Use with large brandy snifters, grande margaritas, carafes and other items with a wide diameter



RG9-1

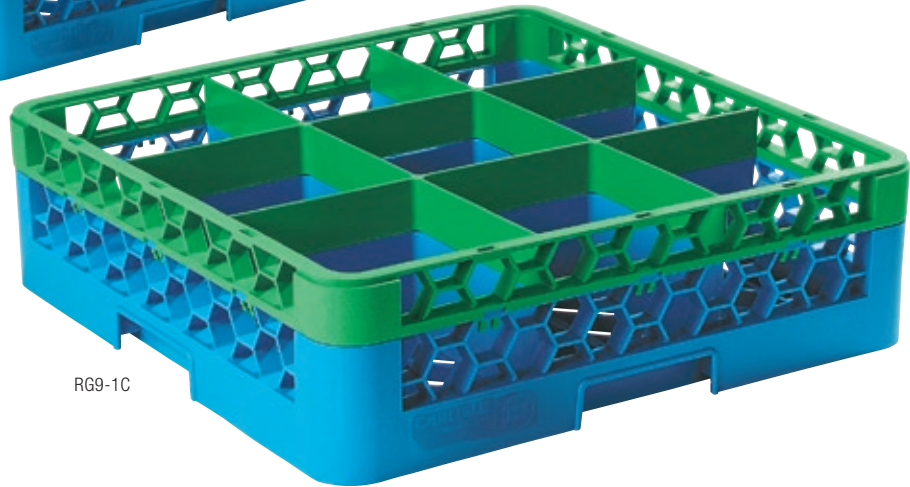

RG9-1C

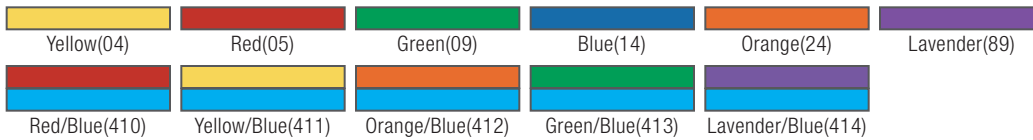

| Prod No | Description | Glass Dia** | Glass Height | Color | Pack |
|---|--------------------------------|-------------|--------------|-------------------------|------|
| 9-Compartment Glass Rack—Compartment Size 5.83" Square | | | | | |
| RG9 Δ | 9-Compartment | 5.56" | 3.19" | 14 | 6 ea |
| RG9-1 Δ | 9-Compartment with 1 Extender | 5.56" | 4.75" | 14 | 4 ea |
| RG9-2 Δ | 9-Compartment with 2 Extenders | 5.56" | 6.34" | 14 | 3 ea |
| RG9-3 Δ | 9-Compartment with 3 Extenders | 5.56" | 7.94" | 14 | 2 ea |
| RG9-4 Δ | 9-Compartment with 4 Extenders | 5.56" | 9.5" | 14 | 2 ea |
| RG9-5 Δ | 9-Compartment with 5 Extenders | 5.56" | 11.1" | 14 | 2 ea |
| RE9 | 9-Compartment Divided Extender | 5.56" | 9.5" | 14 | 6 ea |
| RE* | Open Extender | — | 1.5" | 14 | 6 ea |
| 9-Compartment Color-Coded Glass Rack—Compartment Size 5.83" Square | | | | | |
| RG9-1C Δ | 9-Compartment with 1 Extender | 5.56" | 4.75" | 410, 411, 412, 413, 414 | 4 ea |
| RG9-2C Δ | 9-Compartment with 2 Extenders | 5.56" | 6.34" | 410, 411, 412, 413, 414 | 3 ea |
| RG9-3C Δ | 9-Compartment with 3 Extenders | 5.56" | 7.94" | 410, 411, 412, 413, 414 | 2 ea |
| RG9-4C Δ | 9-Compartment with 4 Extenders | 5.56" | 9.5" | 410, 411, 412, 413, 414 | 2 ea |
| RG9-5C Δ | 9-Compartment with 5 Extenders | 5.56" | 11.1" | 410, 411, 412, 413, 414 | 2 ea |
| RE9C | 9-Compartment Divided Extender | 5.56" | 1.5" | 04, 05, 09, 24, 89 | 6 ea |
| RE* | Open Extender | — | 1.5" | 14 | 6 ea |

NSF Listed products are designated with a Δ and may be prefixed with an N

*Note: The RE Open Extender can be used with any OptiClean Glass or Dish Rack

**Dimensions shown are for the recommended maximum glass size for the compartment

16-Compartment

- Perfect for large cocktail glasses and delicate wine stems with oversize bowls



RG16-1



RG16-2C

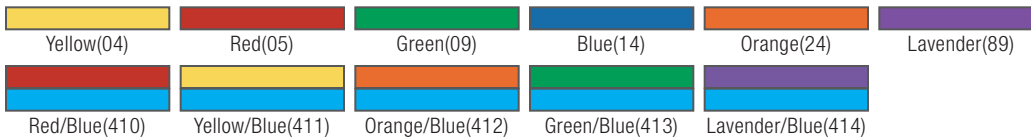

Prod No Description Glass Dia Glass Height Color Pack**

16-Compartment OptiClean Glass Rack—Compartment Size 4.45" Square

| | | | | | |
|-----------------|---------------------------------|-------|-------|----|------|
| RG16 Δ | 16-Compartment | 4.19" | 3.19" | 14 | 6 ea |
| RG16-1 Δ | 16-Compartment with 1 Extender | 4.19" | 4.75" | 14 | 4 ea |
| RG16-2 Δ | 16-Compartment with 2 Extenders | 4.19" | 6.34" | 14 | 3 ea |
| RG16-3 Δ | 16-Compartment with 3 Extenders | 4.19" | 7.94" | 14 | 2 ea |
| RG16-4 Δ | 16-Compartment with 4 Extenders | 4.19" | 9.5" | 14 | 2 ea |
| RG16-5 Δ | 16-Compartment with 5 Extenders | 4.19" | 11.1" | 14 | 2 ea |
| RE16 | 16-Compt Divided Extender | 4.19" | 1.5" | 14 | 6 ea |
| RE* | Open Extender | — | 1.5" | 14 | 6 ea |

16-Compartment OptiClean Color-Coded Glass Rack—Compartment Size 4.45" Square

| | | | | | |
|------------------|---------------------------------|-------|-------|-------------------------|------|
| RG16-1C Δ | 16-Compartment with 1 Extender | 4.19" | 4.75" | 410, 411, 412, 413, 414 | 4 ea |
| RG16-2C Δ | 16-Compartment with 2 Extenders | 4.19" | 6.34" | 410, 411, 412, 413, 414 | 3 ea |
| RG16-3C Δ | 16-Compartment with 3 Extenders | 4.19" | 7.94" | 410, 411, 412, 413, 414 | 2 ea |
| RG16-4C Δ | 16-Compartment with 4 Extenders | 4.19" | 9.5" | 410, 411, 412, 413, 414 | 2 ea |
| RG16-5C Δ | 16-Compartment with 5 Extenders | 4.19" | 11.1" | 410, 411, 412, 413, 414 | 2 ea |
| RE16C | 16-Compartment Divided Extender | 4.19" | 1.5" | 04, 05, 09, 24, 89 | 6 ea |
| RE* | Open Extender | — | 1.5" | 14 | 6 ea |

NSF Listed products are designated with a Δ and may be prefixed with an N

*Note: The RE Open Extender can be used with any OptiClean Glass or Dish Rack

**Dimensions shown are for the recommended maximum glass size for the compartment



OPTICLEAN®

25-Compartment

- Use for large diameter beverage glasses, red wine stems, goblets and most rocks glasses



RG25-1

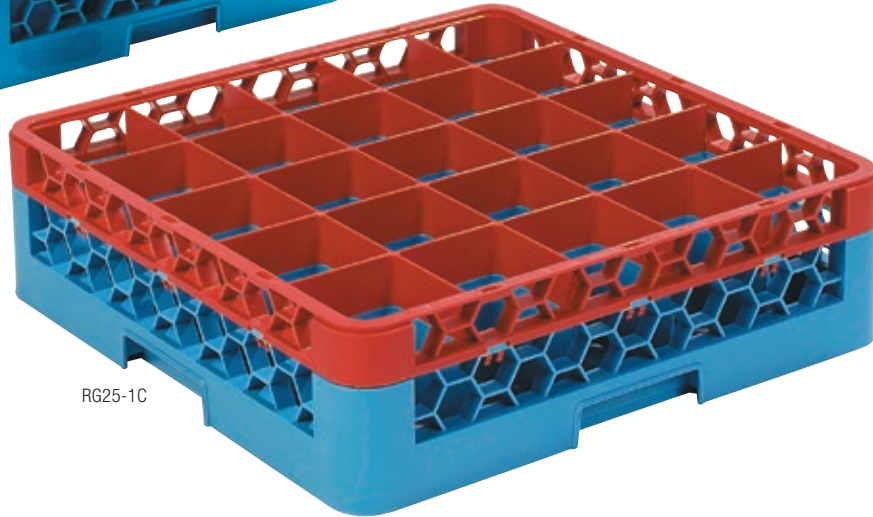

RG25-1C

Find The Perfect Glass Rack
www.carlislefsp.com/FINDRACK

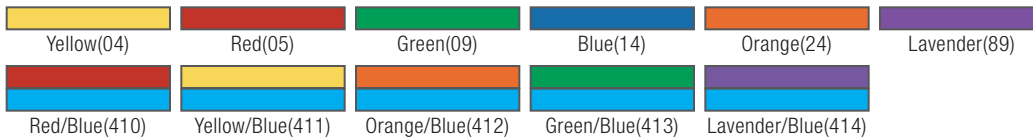

| Prod No | Description | Glass Dia** | Glass Height | Color | Pack |
|--|---------------------------------|-------------|--------------|-------------------------|------|
| 25-Compartment OptiClean Glass Rack—Compartment Size 3.54" Square | | | | | |
| RG25 Δ | 25-Compartment | 3.25" | 3.19" | 14 | 6 ea |
| RG25-1 Δ | 25-Compartment with 1 Extender | 3.25" | 4.75" | 14 | 4 ea |
| RG25-2 Δ | 25-Compartment with 2 Extenders | 3.25" | 6.34" | 14 | 3 ea |
| RG25-3 Δ | 25-Compartment with 3 Extenders | 3.25" | 7.94" | 14 | 2 ea |
| RG25-4 Δ | 25-Compartment with 4 Extenders | 3.25" | 9.5" | 14 | 2 ea |
| RG25-5 Δ | 25-Compartment with 5 Extenders | 3.25" | 11.1" | 14 | 2 ea |
| RE25 | 25-Compartment Divided Extender | 3.25" | 1.5" | 14 | 6 ea |
| RE* | Open Extender | — | 1.5" | 14 | 6 ea |
| 25-Compartment OptiClean Color-Coded Glass Rack—Compartment Size 3.54" Square | | | | | |
| RG25-1C Δ | 25-Compartment with 1 Extender | 3.25" | 4.75" | 410, 411, 412, 413, 414 | 4 ea |
| RG25-2C Δ | 25-Compartment with 2 Extenders | 3.25" | 6.34" | 410, 411, 412, 413, 414 | 3 ea |
| RG25-3C Δ | 25-Compartment with 3 Extenders | 3.25" | 7.94" | 410, 411, 412, 413, 414 | 2 ea |
| RG25-4C Δ | 25-Compartment with 4 Extenders | 3.25" | 9.5" | 410, 411, 412, 413, 414 | 2 ea |
| RG25-5C Δ | 25-Compartment with 5 Extenders | 3.25" | 11.1" | 410, 411, 412, 413, 414 | 2 ea |
| RE25C | 25-Compartment Divided Extender | 3.25" | 1.5" | 04, 05, 09, 24, 89 | 6 ea |
| RE* | Open Extender | — | 1.5" | 14 | 6 ea |

NSF Listed products are designated with a Δ and may be prefixed with an N

*Note: The RE Open Extender can be used with any OptiClean Glass or Dish Rack

**Dimensions shown are for the recommended maximum glass size for the compartment

36-Compartment

- Use with tumblers, white wine glasses and other narrow bowl stems

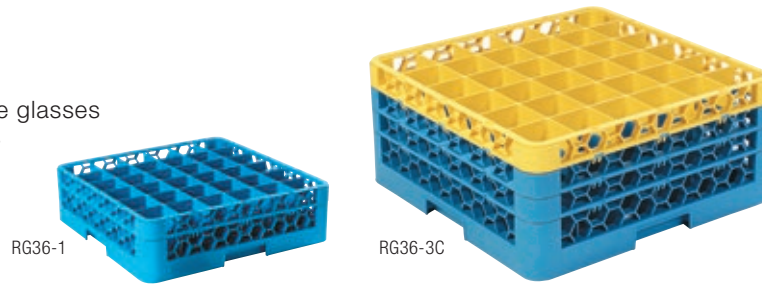

| Prod No | Description | Glass Dia** | Glass Height | Color | Pack |
|---------|-------------|-------------|--------------|-------|------|
|---------|-------------|-------------|--------------|-------|------|

36-Compartment OptiClean Glass Rack—Compartment Size 2.94" Square

| | | | | | |
|-----------------|---------------------------------|-------|-------|----|------|
| RG36 Δ | 36-Compartment | 2.69" | 3.19" | 14 | 6 ea |
| RG36-1 Δ | 36-Compartment with 1 Extender | 2.69" | 4.75" | 14 | 4 ea |
| RG36-2 Δ | 36-Compartment with 2 Extenders | 2.69" | 6.34" | 14 | 3 ea |
| RG36-3 Δ | 36-Compartment with 3 Extenders | 2.69" | 7.94" | 14 | 2 ea |
| RG36-4 Δ | 36-Compartment with 4 Extenders | 2.69" | 9.5" | 14 | 2 ea |
| RG36-5 Δ | 36-Compartment with 5 Extenders | 2.69" | 11.1" | 14 | 2 ea |
| RE36 | 36-Compartment Divided Extender | 2.69" | 1.5" | 14 | 6 ea |
| RE* | Open Extender/Hgt: 1.5" | — | 1.5" | 14 | 6 ea |

36-Compartment OptiClean Color-Coded Glass Rack—Compartment Size 2.94" Square

| | | | | | |
|------------------|---------------------------------|-------|-------|-------------------------|------|
| RG36-1C Δ | 36-Compartment with 1 Extender | 2.69" | 4.75" | 410, 411, 412, 413, 414 | 4 ea |
| RG36-2C Δ | 36-Compartment with 2 Extenders | 2.69" | 6.34" | 410, 411, 412, 413, 414 | 3 ea |
| RG36-3C Δ | 36-Compartment with 3 Extenders | 2.69" | 7.94" | 410, 411, 412, 413, 414 | 2 ea |
| RG36-4C Δ | 36-Compartment with 4 Extenders | 2.69" | 9.5" | 410, 411, 412, 413, 414 | 2 ea |
| RG36-5C Δ | 36-Compartment with 5 Extenders | 2.69" | 11.1" | 410, 412, 413, 414 | 2 ea |
| RE36C | 36-Compartment Divided Extender | 2.69" | 1.5" | 04, 05, 09, 24, 89 | 6 ea |

49-Compartment

- Ideal for juice glasses, narrow champagne flutes, cordials and shot glasses

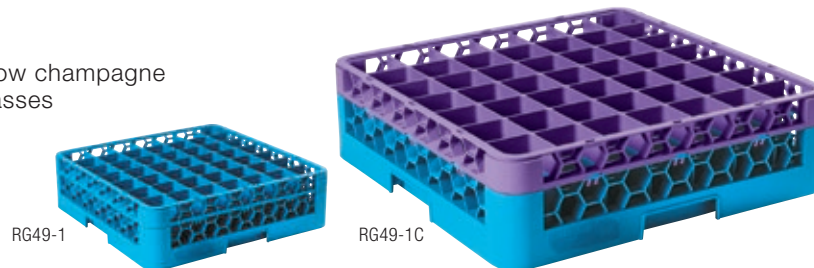

| Prod No | Description | Glass Dia** | Glass Height | Color | Pack |
|---------|-------------|-------------|--------------|-------|------|
|---------|-------------|-------------|--------------|-------|------|

49-Compartment Glass Rack—Compartment Size 2.91" Square

| | | | | | |
|-----------------|----------------------------------|-------|-------|----|------|
| RG49 Δ | 49-Compartment | 2.13" | 3.19" | 14 | 6 ea |
| RG49-1 Δ | 49-Compartment with 1 Extender | 2.13" | 4.75" | 14 | 4 ea |
| RG49-2 Δ | 49-Compartment with 2 Extenders | 2.13" | 6.34" | 14 | 3 ea |
| RG49-3 Δ | 49-Compartment with 3 Extenders | 2.13" | 7.94" | 14 | 2 ea |
| RG49-4 Δ | 49-Compartment with 4 Extenders | 2.13" | 9.5" | 14 | 2 ea |
| RE49 | 49-Compartment Divided Extenders | 2.13" | 1.5" | 14 | 6 ea |
| RE* | Open Extender | — | 1.5" | 14 | 6 ea |

49-Compartment Color-Coded Glass Rack—Compartment Size 2.91" Square

| | | | | | |
|------------------|---------------------------------|-------|-------|-------------------------|------|
| RG49-1C Δ | 49-Compartment with 1 Extender | 2.13" | 4.75" | 410, 411, 412, 413, 414 | 4 ea |
| RG49-2C Δ | 49-Compartment with 2 Extenders | 2.13" | 6.34" | 410, 411, 412, 413, 414 | 3 ea |
| RG49-3C Δ | 49-Compartment with 3 Extenders | 2.13" | 7.94" | 410, 411, 412, 413, 414 | 2 ea |
| RG49-4C Δ | 49-Compartment with 4 Extenders | 2.13" | 9.5" | 410, 411, 412, 413, 414 | 2 ea |
| RG49-5C Δ | 49-Compartment with 5 Extenders | 2.13" | 11.1" | 410, 411, 412, 413, 414 | 2 ea |
| RE49C | 49-Compartment Divided Extender | 2.13" | 1.5" | 04, 05, 09, 24, 89 | 6 ea |

NSF Listed products are designated with a Δ and may be prefixed with an N

*Note: The RE Open Extender can be used with any OptiClean Glass or Dish Rack

**Dimensions shown are for the recommended maximum glass size for the compartment



OPTICLEAN®

Dish Racks

OptiClean Dish Racks offer the safest and most sanitary cleaning choices for everything from the most fragile tableware to heavy-duty kitchen items such as utensils and cutlery. These racks are NSF Listed and offer all the same great features as the rest of Carlisle's wash racks such as sturdy double wall construction and Comfort Curve™ Handles molded into all four sides.



Peg Racks

- Holds plates, trays and platters at the best angle to take full advantage of today's multiple spray, high-pressure dishwashers
- Plate locks hold dishes firmly in place to protect delicate rims, reduce chipping and breakage
- Use with additional Open Extenders (RE) to create the perfect rack for irregular or oversize drinkware
- NSF Listed

Tall Peg Plate & Tray Rack

- Extra tall 2.94" pegs are ideal for charger plates, pasta bowls, large platters and trays

Open End Peg Rack

- Tall 2.94" pegs with open ended design hold all types of trays, standard size baking sheets and other long items

Open/Bowl Rack

- Sturdy open bottom rack is ideal for all large bowls, containers, brushes, cookware and cutlery

Combination/Flatware Rack

- Bottom grid allows for free flow of water and air
- Keeps flatware in place for thorough washing and drying
- Perfect for ramekins and other small items
- NSF Listed



RTP

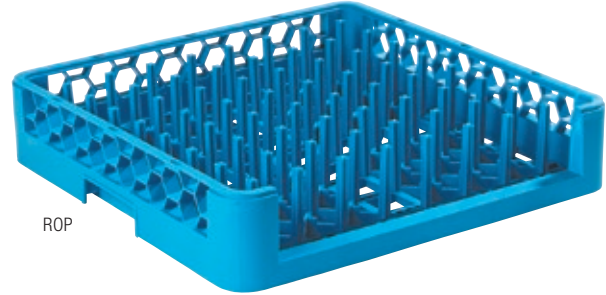

RTP Δ



ROP Δ



RB Δ

| Prod No | Description | Color | Pack |
|--------------------------------------|-------------------------------|-------|------|
| Peg Racks & Extender | | | |
| RP | All-Purpose Plate & Tray Rack | 14 | 6 ea |
| RTP Δ | Tall Peg Plate & Tray Rack | 14 | 6 ea |
| ROP Δ | Open End Peg Rack | 14 | 6 ea |
| RE* | Open Extender | 14 | 6 ea |
| Open/Bowl Rack & Extender | | | |
| RB Δ | Open/Bowl Rack | 14 | 6 ea |
| RE* | Open Extender | 14 | 6 ea |
| Combination/Flatware Rack | | | |
| RF Δ | Combination/Flatware Rack | 14 | 6 ea |
| RE* | Open Extender | 14 | 6 ea |

Blue(14)

NSF Listed products are designated with a Δ and may be prefixed with an N

*Note: The RE Open Extender can be used with any OptiClean Glass or Dish Rack

Cup Racks

- Tilted design promotes thorough washing of rims and interiors
- Encourages concaved bases to drain more efficiently, eliminating pooling water
- 16-Compartment holds larger diameter cups and mugs in tilted position; compartment size: 4.34" x 4.34"
- 20-Compartment works with most standard size cups; compartment size: 4.34" x 3.41"
- NSF Listed



Bakery Tray & Sheet Pan Rack

- Rack securely holds sheet or bun pans low enough to fit standard height dish machine openings
- Contents are angled to take full advantage of multiple spray arms
- NSF Listed



Food Pan/Insulated Meal Delivery Tray Rack

- Accommodates all sizes of 2.5" deep food pans and standard steam table inserts
- Racks are angled for thorough cleaning
- Perfect for health care or correctional facilities using insulated meal delivery compartment trays
- NSF Listed



Plate Cover Rack

- Use with plate covers, dishwasher safe insulated dome covers or dishwasher safe pellet bases
- Specially designed insert keeps contents separated during washing
- NSF Listed



RC20-1



RSP



RFP



RPC

Blue(14)

Prod No Description

Color

Pack

Cup Racks

| | | | |
|-----------------|--|----|------|
| RC16 Δ | 16-Compartment Cup Rack | 14 | 6 ea |
| RC16-1 Δ | 16-Compartment Cup Rack with 1 Open Extender | 14 | 4 ea |
| RC20 Δ | 20-Compartment Cup Rack | 14 | 6 ea |
| RC20-1 Δ | 20-Compartment Cup Rack with 1 Open Extender | 14 | 4 ea |

Bakery Tray & Sheet Pan Rack

| | | | |
|--------------|------------------------------|----|------|
| RSP Δ | Bakery Tray & Sheet Pan Rack | 14 | 3 ea |
|--------------|------------------------------|----|------|

Food Pan/Insulated Meal Delivery Tray Rack

| | | | |
|--------------|--|----|------|
| RFP Δ | Food Pan/Insulated Meal Delivery Tray Rack | 14 | 3 ea |
|--------------|--|----|------|

Plate Cover Rack

| | | | |
|--------------|------------------|----|------|
| RPC Δ | Plate Cover Rack | 14 | 3 ea |
|--------------|------------------|----|------|

NSF Listed products are designated with a Δ and may be prefixed with an N
 *Note: The RE Open Extender can be used with any OptiClean Glass or Dish Rack



OPTICLEAN® ACCESSORIES

Hold Down Grid

- Use with small, light-weight or delicate items to prevent them from being displaced by high pressure sprayers
- Snaps down securely and fits all OptiClean Glass & Dish Racks
- NSF Listed



C93



Half Size Stack-All™ Racks

- Compact 10" x 19.75" size will work in any 19.75" dishwasher
- Sturdy single wall construction
- Open design for superior water and air circulation
- Made of high impact polypropylene
- NSF Listed

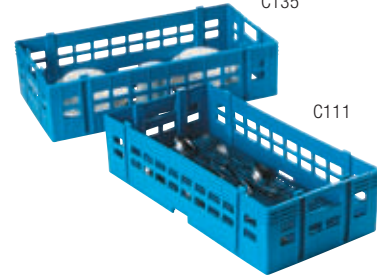

C135

C111



Perma-Sil™ Cylinders & Carriers

Flatware Cylinders

- Meshed bottom and open sides are best for the dispersion of water and air; ideal for washing or storing flatware

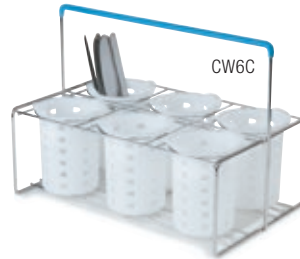

CW6C



C35P

Carriers

- Heavy gauge wire construction is chrome plated
- Vinyl-coated insulated handle

Perma-San™ Flatware Washing Baskets

- Open design for easy cleaning of vertically stored flatware
- Use with RF Flatware Rack or RB Open/Bowl Rack as part of a complete flatware sanitizing system
- Tough polypropylene material resists grease and detergents
- C32P1 and C32P2 are NSF Listed

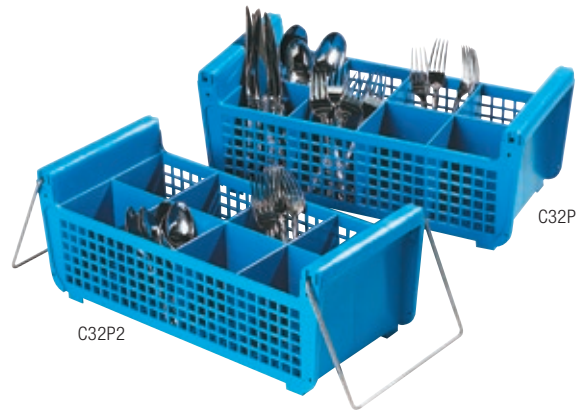

C32P1

C32P2

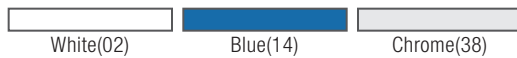

| Prod No | Description | Glass Height | Color | Pack |
|---|---------------------------------|--------------|-------|-------|
| Hold Down Grid | | | | |
| C93 ▲ | Vinyl Coated Wire Grid | — | 14 | 6 ea |
| Half Size Stack-All Racks | | | | |
| C135 ▲ | Open Bowl/Cup/Glass Rack | 4.5" | 14 | 6 ea |
| C111 ▲ | Flatware Rack | 4.5" | 14 | 6 ea |
| Perma-Sil Cylinders & Carriers | | | | |
| C35P | Poly Cylinder | — | 02 | 12 ea |
| CW6C | 6-Compartment Portable Carrier | — | 38 | 6 ea |
| C32P1 ▲ | Flatware Basket without Handles | — | 14 | 6 ea |
| C32P2 ▲ | Flatware Basket with Handles | — | 14 | 6 ea |

NSF Listed products are designated with a ▲ and may be prefixed with an N

E-Z Glide™ Rack Dollies

Aluminum Dollies

- Hold and transport any 19.75" square stack of glass racks
- Large 4" ball bearing swivel casters with non-marking rubber wheels
- 300 lb weight capacity

Polypropylene Dollies

- C2236/C2236H injection molded dollies squared corners are designed to hold any standard 19.75" racks including older style square racks
- 350 lb weight capacity
- Dollies trap water from wet racks; convenient drain feature underneath the dolly makes emptying water easy



Dust Cover

- Heavy-duty vinyl covers keep tableware clean during storage
- Easily converts warewashing racks into storage racks
- Combine with E-Z Glide Dollies and Rack Covers (shown left) for a complete storage system

Rack Cover

- Hard cover protects rack contents during storage



| Prod No | Description | Color | Pack |
|-------------------------------|--|--------|------|
| E-Z Glide Rack Dollies | | | |
| C2220A | Open Aluminum Dolly, No Handle | 14 | 1 ea |
| C2222A | Open Aluminum Dolly with Handle | 14 | 1 ea |
| C2236 | Warewashing Rack Dolly, No Handle | 03, 14 | 1 ea |
| C2236H | Warewashing Rack Dolly with Handle | 03, 14 | 1 ea |
| C2237 | Handle for C2236 & C2236H | 03 | 1 ea |
| C2222C | Replacement Caster for C2220A & C2222A | 00 | 1 ea |
| C2222HD | Handle for C2220A & C2222A | 38 | 1 ea |
| Rack Cover | | | |
| RHC | Rack Cover | 02 | 1 ea |
| Dust Covers | | | |
| RDC ♦ | 36" Long Rack Dust Cover | 07 | 3 ea |
| RDC1 ♦ | 48" Long Rack Dust Cover | 07 | 3 ea |

NSF Listed products are designated with a **Δ** and may be prefixed with an N

♦ California Residents: Di(2-ethylhexylphthalate (DEHP) **WARNING:** See appendix B on page 1



PLAQUE-A-RACK

Carlisle's Plaque-A-Rack System is the proven standard in custom rack labeling. The highly visible plaques fit up to three across on both bases and extenders for complete versatility. Plaques can be easily added, removed or changed as needed. Sturdy reusable plaques are made from a high-impact plastic and won't come off during the normal wear and tear of daily usage – offering a permanent identification system for the life of your racks.



Plaque example shown above: XRG25-2 with 203, 303, 103

- Plaque-A-Rack provides four ways to customize your Glass Rack System:
 - glassware silhouette
 - glassware style by name
 - location of glassware usage or storage
 - custom color coding options
- Plaques are hot stamped for durability
- Plaques are Carlisle Blue(14), unless otherwise specified
- All plaques are 3" long by 1" high with a printable area of 2-1/4" long by 11/16" high
- Racks can be ordered with up to three possible plaque imprints
- There is a \$4.16 U.S. list price charge per rack for each Plaque-A-Rack order (includes 2 plaques on 2 sides); special orders for plaques on all four sides have a \$8.32 U.S. list price (includes 2 plaques on 4 sides)
- Plaques may also be ordered separately at \$1.04 U.S. list price each
- Plaques are placed horizontally on two opposite

- sides of the rack along the top most edge
- Plaques snap on for a tight fit; won't fall off during normal use
- Plaques can be removed if necessary and are re-usable
- Allow ten working days for shipment of your standard order
- Plaques sold in full case quantities only
- Please allow 4-6 weeks from approval of sample for custom plaques
- Custom imprinted plaques are \$1.04 U.S. list price each with an additional \$50 U.S. net price setup fee per plate
- An additional \$142 U.S. net price dye charge will apply to any plaque order that does not include racks
- For custom color coding, please specify which color is to be used for each rack
- Custom plaques have a max of 9 characters in upper/lower case; 7 character max in all caps
- All plaque sales are final

How To Order

Follow instructions below and refer to the charts on the facing page for catalog numbers.

Step 1: Choose the glass rack that best fits your glassware.

Step 2: Plaque-A-Rack glass racks are identified by an "X" preceding the standard glass rack catalog number (example: "X"RG25-1 25-Compartment Plaque-A-Rack glass rack with one extender).

Step 3: Choose the different imprints you want from the types of plaque imprints available.

- Silhouette
- Name of glassware
- Location

Step 4: Place the three digit plaque catalog imprint product number next to the standard glass rack catalog number.

EXAMPLE:

Rack Choice: RG25-1
 Silhouette: Red Wine
 Glassware Name: Red Wine
 Location: Service Bar
 Catalog No: XRG25-1 204 304 104

Standard Color





























Custom Colors

- Minimum order 36 pieces



LOCATION
GLASS RACK

| CAT. NUMBER | IMPRINT | CATALOG NUMBER | | |
|-------------|--------------|----------------|---------|---------|
| 100 | (BLANK) | XRG16 | XRG25-2 | XRG36-4 |
| 101 | KITCHEN | XRG16-1 | XRG25-3 | XRG9 |
| 102 | DINING | XRG16-2 | XRG25-4 | XRG9-1 |
| 103 | BANQUET | XRG16-3 | XRW30 | XRG9-2 |
| 105 | POOLSIDE | XRG16-4 | XRW30-1 | XRG9-3 |
| 106 | STORAGE | XRW20 | XRW30-2 | XRG49 |
| 107 | RM SERV | XRW20-1 | XRW30-3 | XRG49-1 |
| 108 | BALLROOM | XRW20-2 | XRG36 | XRG49-2 |
| 109 | BAR | XRW20-3 | XRG36-1 | XRG49-3 |
| 110 | HOUSEKEEPING | XRG25 | XRG36-2 | |
| | | XRG25-1 | XRG36-3 | |

| SILHOUETTE | | NAME OF GLASS | | SILHOUETTE | | NAME OF GLASS | |
|------------|---|---------------|------------|------------|--|---------------|-------------|
| CAT.# | IMPRINT | CAT.# | IMPRINT | CAT.# | IMPRINT | CAT.# | IMPRINT |
| PLQ | (BLANK) | PLQ | (BLANK) | 214 |  | 314 | MUG |
| 201 |  | 301 | CHAMPAGNE | 215 |  | 315 | FOOTED CUP |
| 202 |  | 302 | CHAMPAGNE | 217 |  | 317 | HI BALL |
| 203 |  | 303 | WHITE WINE | 218 |  | 318 | ICED TEA |
| 204 |  | 304 | RED WINE | 219 |  | 319 | FLUTED |
| 205 |  | 305 | ROCKS | 221 |  | 321 | GOBLET |
| 206 |  | 306 | WATER | 222 |  | 322 | WINE |
| 207 |  | 307 | COOLER | 224 |  | 323 | MARGARITA |
| 208 |  | 308 | PILSNER | 226 |  | 324 | BEER |
| 209 |  | 310 | PARFAIT | 227 |  | 326 | HURRICANE |
| 211 |  | 311 | BRANDY | 228 |  | 327 | MARTINI |
| 212 |  | 312 | TULIP | 229 |  | 328 | CORDIAL |
| 213 |  | 313 | SOUR | 230 |  | 329 | DESSERT |
| | | | | 235 |  | 330 | CUP |
| | | | | | | 335 | OLD FASHION |
| | | | | | | 633 | COFFEE CUP |

BUS BOXES

Tote Boxes

- Unique reinforced rims reduce bending, bowing, and breaking
- Excellent for storing and separating food products
- Comfort Curve™ handles for a sure, comfortable grip
- Contour lid design allows easy box-on-box stacking
- Available in 8 different colors for HACCP zone use
- NSF Std 21 – meets the criteria for thermoplastic refuse containers
- NSF Std 2 – meets the criteria for food contact and cleanability

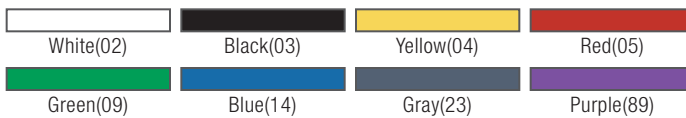

| Prod No | Description | Color | Pack |
|-------------------|------------------------------|--------------------------------|-------|
| Tote Boxes | | | |
| N44010 Δ | Tote Box 15" x 20" x 5" Deep | 02, 03, 04, 05, 09, 14, 23, 89 | 12 ea |
| N44011 Δ | Tote Box 15" x 20" x 7" Deep | 02, 03, 04, 05, 09, 14, 23, 89 | 12 ea |
| N44012 Δ | Universal Lid | 02, 03, 04, 05, 09, 14, 23, 89 | 12 ea |

NSF Listed products are designated with a Δ and may be prefixed with an N

Save-All™ Compartmented Bus Boxes

- Silverware tray and heavy-duty bus boxes feature contoured handles for easy handling
- Scuff, grease and stain-resistant
- Silverware Tray measures 21.25" x 11.5" x 3.75" H
- 0386 Save-All Bus Box has separate compartments, one for flatware, one for plates and debris; measures 22" x 17" x 5" H
- Dishwasher safe



Bus Boxes

- Unique reinforced rims reduce bending, bowing and breaking – protecting your valuable tableware investment
- Comfort Curve™ handles for a sure, comfortable grip
- Contour lid design allows easy box-on-box stacking
- 44010, 44011, 44012 in White are NSF Listed



44011SKD



Use Bus Boxes to create a Wash-Rinse-Sanitize station



| Prod No | Description | Color | Pack |
|---|----------------------------------|----------------|--------|
| Save-All Compartmented Bus Boxes | | | |
| 1071 | Save-All Silverware Tray | 23 | 6 ea |
| 0386 | Save-All Bus Box | 23 | 12 ea |
| Bus Boxes | | | |
| 44010 | Bus Box 15" x 20" x 5" Deep | 01, 02, 03, 23 | 12 ea |
| 44011 | Bus Box 15" x 20" x 7" Deep | 01, 02, 03, 23 | 12 ea |
| 44012 | Universal Lid | 01, 02, 03, 23 | 12 ea |
| 44010SKD* | Bus Box Skid 15" x 20" x 5" Deep | 03, 23 | 300 ea |
| 44011SKD* | Bus Box Skid 15" x 20" x 7" Deep | 03, 23 | 240 ea |

*Note: 44010SKD, 44011SKD cannot ship UPS/FedEx Ground



CARLISLE
FOODSERVICE PRODUCTS

PROVEN
EFFICIENT
RELIABLE
**CLEANING
TOOLS**

Trust Carlisle's equipment cleaning brushes and kitchen tools to help keep your food service operation healthy, safe and profitable. These products are another way Carlisle helps you make work easy.



SPARTA



The Right Brush For Every Job

We offer more than 2,000 brushes and cleaning tools, each ergonomically designed with the end user in mind to provide optimum cleaning results for *you*.



Since 1908

we've been manufacturing high-quality brushes and cleaning tools. We have developed unmatched expertise, consistently delivering innovative cleaning solutions.



The Highest Quality

and best suited materials for efficient use and durability. These outstanding Sparta Brush features save you time and money.



Custom Designed

for each specific cleaning application.



Proven

Sparta Brush quality excels in foodservice and food processing including fine restaurants, hotels, schools, hospitals, lunch counters, cafeterias, supermarket bakeries, meat departments and delicatessens.

Our Commitment

to the customer never ends and our mission is to give 100% customer satisfaction.

SPARTA
BRUSH



Maintain a healthy foodservice environment with the **Sparta® 21 Key Brush** solution!

This program is specifically tailored for food service operators to help you prevent the spread of food-borne illness and comply with FDA Food Codes

PASTRY & BASTING



#1 Hot Use
40374



#2 Cold Use
40401



#3 Silicone Basting Brush
40405

FLOOR CLEANING



#4 24" Double Foam Rubber Squeegee
40082



#5 Hi-Lo™ Floor Scrub
40423



#6 Duo-Sweep™ Angle Broom
36885



#7 24" Omni® Floor Sweep
41881

FOOD PREPARATION



#8 Vegetable Brush
40164



#9 6" Cutting Board Brush
40521

GENERAL CLEANUP



#10 8" Polyester Scrub Brush
40541



#11 20" Polyester Scrub Brush
40501



#12 Scratch Brush with Scraper
40671

KITCHEN EQUIPMENT



#13 Broiler Master Brush
40290



#14 L-Tipped High Heat Fryer Brush
40111

BEVERAGE SERVICE



#15 12" Carafe/Bottle Brush
40000



#16 Coffee Decanter Brush
40025

FLOOR DRAIN CLEANING



#17 Floor Drain Brush
40146



#18 36" Plastic Drain Brush Handle
40236



#19 Drain Opening Tool
40144

WASHROOM & PERSONAL HYGIENE



#20 Hand and Nail Brush
40020



#21 Polyester Bowl Brush
40140

21 Key Brush Kit - 990021KIT00

21 KEY BRUSHES

#3 Silicone Basting Brush **40405**



#13 Broiler Master Brush **40290**



#14 L-Tipped High Heat Fryer Brush **40111**



#12 Scratch Brush w/ Scraper **40671**



#1 Hot Use **40374**



#2 Cold Use **40401**



#5 Hi-Lo Floor Scrub **40423**



#17 Floor Drain Brush **40146**



#18 36" Plastic Drain Brush Handle **40236**



#19 Drain Opening Tool **40144**



#10 8" Polyester Scrub Brush **40541**



21 Key Brush Kit - 990021KIT00

#16 Coffee Decanter
Brush **40025**



#15 12" Carafe/Bottle
Brush **40000**



#20 Hand & Nail
Brush **40020**



#21 Polyester Bowl
Brush **40140**



#8 Vegetable
Brush **40164**



#11 20" Polyester
Scrub Brush **40501**



#9 6" Cutting
Board Brush **40521**



#4 24" Double Foam
Rubber Squeegee **40082**



#6 Duo-Sweep™ Angle
Broom **36885**



#7 24" Omni® Floor
Sweep **41881**



SMALLWARES BRUSHES

Atlas™ Multi-Purpose Brushes

- Versatile design for a wide variety of applications
- Multiple trim angles on bristles give you better surface contact for better cleaning
- Available with ergonomic pistol grip handles in 8" and 20" lengths
- Rugged plastic handles and crimped staple set polyester bristles will not absorb oils or moisture
- Base resins used to produce blocks and bristles are made of FDA compliant materials
- Full color-coded products offer easy identification for tool segregation



| | |
|--|-------------------|
| | Allergen Control |
| | Dairy or Dry Food |
| | Produce |
| | Prepared Food |
| | Meat |
| | Fish |
| | Poultry |



SPARTA
BRUSH
Famous for Quality

Cutting Board Brushes

- Ergonomically shaped handles and crimped staple set polyester bristles are rugged and will not absorb food oils or moisture
- Segregate brushes and boards by color to help prevent cross contamination
- Base resins used to product blocks and bristles are made of FDA compliant materials



| | | | | |
|-----------|-----------|------------|------------|-----------|
| White(02) | Black(03) | Yellow(04) | Red(05) | Green(09) |
| Blue(14) | Tan(25) | Purple(68) | Purple(89) | |

Prod No Description Recommended Cleaning Color Pack

Atlas Multi-Purpose Brushes

| Prod No | Description | Recommended Cleaning | Color | Pack |
|---------|---|----------------------|--------------------|-------|
| 40000 | 12" Handle, 2.75" Round with Soft Polyester Bristles | Drinkware/Dishes | 02, 25 | 12 ea |
| 40000C | 12" Handle, 2.75" Round with Soft Polyester Bristles, Color-Coded | Drinkware/Dishes | 02, 04, 05, 09, 14 | 6 ea |
| 40001 | 16" Handle, 3.25" Round with Soft Polyester Bristles | Drinkware/Dishes | 02, 03, 68 | 12 ea |
| 40001C | 16" Handle, 3.25" Round with Soft Polyester Bristles, Color-Coded | Drinkware/Dishes | 02, 04, 05, 09, 14 | 6 ea |
| 40002 | 16" Handle, 3.5" x 5" Oval with Polyester Bristles | Pots/Pans/Tanks | 02 | 6 ea |
| 40002C | 16" Handle, 3.5" x 5" Oval with Polyester Bristles, Color-Coded | Pots/Pans/Tanks | 04, 05, 09, 14 | 6 ea |
| 40003 | 30" Handle, 3.5" x 5" Oval with Polyester Bristles | Pots/Pans/Tanks | 02 | 6 ea |
| 40003C | 30" Handle, 3.5" x 5" Oval with Polyester Bristles, Color-Coded | Pots/Pans/Tanks | 04, 05, 09, 14 | 6 ea |
| 40004 | 16" Handle, 3" Round with Polyester Bristles | Pots/Pans/Tanks | 02 | 6 ea |
| 40004C | 16" Handle, 3" Round with Polyester Bristles, Color-Coded | Pots/Pans/Tanks | 04, 05, 09, 14 | 6 ea |
| 40005 | 16" Handle, 4" Round with Polyester Bristles | Pots/Pans/Tanks | 02 | 6 ea |
| 40005C | 16" Handle, 4" Round with Polyester Bristles, Color-Coded | Pots/Pans/Tanks | 04, 05, 09, 14 | 6 ea |
| 40006 | 30" Handle, 3" Round with Polyester Bristles | Pots/Pans/Tanks | 02 | 6 ea |
| 40006C | 30" Handle, 3" Round with Polyester Bristles, Color-Coded | Pots/Pans/Tanks | 04, 05, 09, 14 | 6 ea |
| 40007 | 30" Handle, 4" Round with Polyester Bristles | Pots/Pans/Tanks | 02 | 6 ea |
| 40007C | 30" Handle, 4" Round with Polyester Bristles, Color-Coded | Pots/Pans/Tanks | 04, 05, 09, 14 | 6 ea |
| 40008 | 30" Handle, 5" Round with Polyester Bristles | Pots/Pans/Tanks | 02 | 6 ea |
| 40008C | 30" Handle, 5" Round with Polyester Bristles, Color-Coded | Pots/Pans/Tanks | 04, 05, 09, 14 | 6 ea |
| 40010 | 16" Handle, 5" Round with Polyester Bristles | Pots/Pans/Tanks | 02 | 6 ea |
| 40010C | 16" Handle, 5" Round with Polyester Bristles, Color-Coded | Pots/Pans/Tanks | 04, 05, 09, 14 | 6 ea |

Cutting Board Brush

| | | | | |
|-------|--|---|-----------------------------|-------|
| 40521 | 6" Cutting Board Brush with Polyester Bristles, 1.38" trim | — | 02, 04, 05, 09, 14, 25, 89* | 12 ea |
|-------|--|---|-----------------------------|-------|

*Color available by special order only

Sparta® Glass Washing Brushes

- All plastic construction helps prevent glasses from being chipped or broken and helps seal out moisture
- Positive-suction, molded plastic base provides a tight grip in sinks and on countertops
- Heavy-duty polyester bristles with densely filled dome top holds up to extreme use



Sparta Bottle & Jar Brushes

- Wirewound brushes have a small diameter handle and soft bristles for easy and delicate cleaning of jars, bottles and glasses with smaller openings
- 40415 Bottle Brush is perfect for cleaning wine bottles, ketchup bottles, squeeze bottles, beer growlers, etc.



| Prod No | Description | Recommended Cleaning | Color | Pack |
|--|--|----------------------|--------|-------|
| Sparta Glass Washing Brushes | | | | |
| 40460 | 8" Twin Glass Washer, 2.88" trim | Drinkware | 03 | 6 ea |
| 40461 | 8" Triple Glass Washer, 2.88 trim | Drinkware | 02, 03 | 6 ea |
| 41506 | 9.5" Pilsner, Hurricane & Standard Style Triple Glass Washer | Drinkware | 00 | 6 ea |
| 40465 | Standard Refill Brush | Drinkware | 03 | 12 ea |
| 40462 | Shot Glass Cleaning Brush | Drinkware | 03 | 6 ea |
| Sparta Bottle & Jar Brushes | | | | |
| 40466 | 12" Handle Pint Bottle Brush with Polyester Bristles, 2.5" - 3.5" trim | Jars/Carafes/Bottles | 00 | 12 ea |
| 40467 | 16" Handle Quart Bottle Brush with Polyester Bristles, 3" - 4.25" trim | Jars/Carafes/Bottles | 02 | 12 ea |
| 40468 | 16" Handle Half Gallon Brush with Polyester Bristles, 4" - 4.5" trim | Jars/Carafes/Bottles | 00 | 12 ea |
| 40415 | 16.5" Handle Small Bottle Neck Brush with Soft Nylon Bristles | Small Neck Bottles | 00 | 12 ea |

SPECIAL EQUIPMENT BRUSHES

Hot Dog Roller Brush

- Special "V" shaped stiff polyester bristle design cleans hot dog rollers and connecting points at the side walls at one time
- Rids hot dog roller grills of unsanitary grease build-up that could result in mechanical problems



High Temp Fryer Brushes

- Made of stiff, PTFE bristles that withstand temperatures up to 500°F
- Saves time since equipment can be cleaned while hot
- Plastic handles stay cool to the touch
- 40110 Fryer Brush is 28" long to reach tight, narrow spaces
- 40112 Looped Brush cleans fryer bottoms easily
- 40111 and 40116 L-Tipped Fryer Brush for cleaning hot coils
- 40113 Utility Brush for cleaning hot vats, utensils and other equipment



High Temp Waffle & Panini Griddle

- Made of stiff, high heat bristles that withstand temperatures up to 500°F
- Saves time since equipment can be cleaned while hot
- Plastic handles stay cool to the touch
- 40114 has extra stiff bristles for cleaning waffle irons, griddles and grills while still hot
- 40115 is a pastry style brush designed for buttering and basting hot surfaces



| Prod No | Description | Trim | Color | Pack |
|--|-------------------------------------|-----------|-------|-------|
| Hot Dog Roller Brush | | | | |
| 41169 | 24" L Hot Dog Roller Brush | 2" | 00 | 12 ea |
| High Temp Fryer Brushes | | | | |
| 40110 | 28" Straight Fryer Brush | 1.38" | 05 | 12 ea |
| 40120 | 28" Straight Fryer Brush | 1.38" | 05 | 1 ea |
| 40112 | 24" Looped Fryer Brush | 2" | 05 | 6 ea |
| 40122 | 24" Looped Fryer Brush | 2" | 05 | 1 ea |
| 40111 | 23" L-Tipped Fryer Brush | .88" | 05 | 12 ea |
| 40121 | 23" L-Tipped Fryer Brush | .88" | 05 | 1 ea |
| 40113 | 20" Utility Brush | 2" | 05 | 12 ea |
| 40123 | 20" Utility Brush | 2" | 05 | 1 ea |
| High Temp Waffle, Griddle & Equipment Brushes | | | | |
| 40114 | 3" Wide Brush with Teflon Bristles | .94" - 1" | 00 | 12 ea |
| 40115 | 1" Round Brush with Teflon Bristles | 2" | 00 | 12 ea |

NOTE: Heat coil must be turned off prior to using high temperature brushes

Sparta Coffee Service Brushes

- Brushes are designed to clean all glass and Pyrex® pots and dispensers
- 40025 Coffee Decanter Brush is shaped like the inside of the most popular coffee decanters for quick and easy use
- Use 40673 Urn Brush for quick and easy clean-up of glass gauges on coffee urns
- 40154 Creamer and Percolator Brush is designed for cleaning spouts and tubing on percolators, hot beverage servers and creamers
- 40153 Curved Coffee Maker Brush is a semi-circular wire wound brush that contours to the inside of coffee pots



Spouts, Pumps & Valves - Stiff Polyester Bristles

Tee, Fitting and Valve Brush (40180)

- Perfect for straight pipes, tees and valves

Condiment Dispenser Spout Brush (40155)

- Flexible wire for efficient cleaning of bacteria prone spouts

Condiment Dispenser Plunger Brush (40156)

- Rose-bud tip for efficient dispenser cleaning

Beer Tap Line Brush (40157)

- Great for maintaining quality control of beer on tap



| Prod No | Description | Recommended Cleaning | Color | Pack |
|--|--|----------------------|--------|--------|
| Sparta Coffee Service Brushes | | | | |
| 40025 | 16" Coffee Decanter Brush with Soft Polyester Bristles, 4.6" - 6.4" trim | Coffee Decanter | 00 | 6 ea |
| 40673 | 25" Handle Urn Brush with Polyester Bristles, .63" trim | Coffee Urn & Tap | 00 | 12 ea |
| 40154 | 12" Creamer Brush with Polyester Bristles, 1" x 1.5" trim | Coffee Spout | 00 | 24 ea |
| 40153 | 10" Curved Coffee Maker Brush with Soft Polyester Bristles, 1.5" trim | Coffee Maker | 00 | 12 ea |
| Spouts, Pumps & Valve Brushes | | | | |
| 36552 | 8" Spout Brush | Spouts/Faucets | 00 | 144 ea |
| 40157 | 5.25" Beer Tap with Polyester Bristles, .25" trim | Beer Taps | 00 | 24 ea |
| 40180 | 15" Valve & Fitting with Polyester Bristles, 1" trim | Valves & Fittings | 02 | 12 ea |
| 40155 | 13" Spout Brush with Polyester Bristles, .44" trim | Condiment Pumps | 00 | 12 ea |
| 40156 | 10.5" Plunger Brush with Polyester Bristles, .94" trim | Condiment Pumps | 00, 14 | 12 ea |

EQUIPMENT CLEANING BRUSHES

Wok/Gong Utility Brushes

- Clean woks and electric griddles; designed specifically for high heat cleaning
- Wood block handle available in two lengths
- Stiff palmyra bristles are excellent for general cleaning



Low Temperature Equipment Brushes

- 40040 and 40042 Tank and Kettle Brushes have bristles on all sides to provide complete cleaning and can be used with a handle to reach the bottom of kettles and tanks
- 40150 Kettle Drain Valve Brush is a perfect solution for cleaning bacteria prone areas of kettles
- 40152 Cool Temperature Fryer Brush has the same shape as our High Temp Fryer Brush(40111) but is used in cool cleaning



Dishwasher Machine Brush

- Long handle reaches spray arms for more thorough cleaning



Standard(00)

| Prod No | Description | Recommended Cleaning | Color | Pack |
|--|--|----------------------------|-------|-------|
| Wok/Gong Utility Brushes | | | | |
| 45463 | 8.5" Utility Scrub Brush with Stiff Palmyra Bristles | Wok/Gong/Electric Griddles | 00 | 12 ea |
| 45493 | 20" Utility Scrub Brush with Stiff Palmyra Bristles | Wok/Gong/Electric Griddles | 00 | 12 ea |
| Low Temperature Equipment Brushes | | | | |
| 40040 | Tank & Kettle Brush with Nylon Bristles, 5.25" x 7.5" trim | Kettle & Tank | 00 | 12 ea |
| 40042 | Tank & Kettle Brush with Nylon Bristles, 5.5" x 9.5" trim | Kettle & Tank | 00 | 12 ea |
| 40150 | 28" Kettle Valve with Stiff Polyester Bristles, 1.38" trim | Kettle Valve | 00 | 12 ea |
| 40152 | 23" Cool L-Tipped Fryer with Polyester Bristles, .88" trim | Fryer | 00 | 12 ea |
| Dishwasher Machine Brush | | | | |
| 40028 | 35" Dishwasher Spray Arm with Polyester Bristles, 1" trim | Dishwasher | 00 | 12 ea |

Bake Pan Lip Brush

- Easy cleaning of rolled lips and edges on baking pans
- Stiff polyester bristles patterned in a flat V-shape for maximum pan contact
- Contoured handle provides a convenient grip and protects hands from metal edges on pans and other equipment



40024

Vegetable Cutter Brushes

- 40529 has 2.5" long, extra stiff nylon bristles reach through the grid of stainless steel cutters
- 40532 has 4.25" long, extra stiff, nylon bristles



40532



40529

Iron Handle Brush

- Pointed edge to allow cleaning in corners
- Iron style grip is ergonomically designed for comfort and light or medium duty scrubbing



36289



| Prod No | Description | Recommended Cleaning | Color | Pack |
|---------------------------|--|-------------------------------|--------------------|-------|
| Bake Pan Lip Brush | | | | |
| 40024 | 6" Bake Pan Lip Brush with Polyester Bristles, 1" trim | Baking Pans | 02, 04, 05, 09, 14 | 12 ea |
| Cutter Brush | | | | |
| 40529 | 2.5" Vegetable Cutter Brush with Nylon Bristles, 2" trim | Lettuce & Onion Cutters | 00 | 12 ea |
| 40532 | 4.25" Universal Onion/Lettuce Brush | Lettuce & Onion Cutters | 00* | 8 ea |
| Iron Handle Brush | | | | |
| 36289 | 6" Iron Handle Brush with Polypropylene Bristles | Medium Scrubbing/Corner Areas | 00 | 48 ea |

EQUIPMENT CLEANING

Toothbrush Style Utility Brushes

- Narrow profile cleans tight kitchen spaces and around ceramic tile
- Available in a choice of .5" long stiff nylon bristles for normal cleaning; stainless steel or brass bristles for tougher cleaning jobs



Butcher Block Brushes

- Aggressive tempered steel wire bristles scrape away contaminated layers of wooden butcher blocks and wooden cutting boards



Meat Slicer Cleaning Tool

- Keeps hands and fingers away from slicer blade
- Easy clean-up of slicers without disassembling slicer
- Slicer tool has scraper on one end for scraping hardened foods
- Scrub pad wraps around meat slicer tool for a one-time thorough cleaning



| Prod No | Description | Recommended Cleaning | Color | Pack |
|---|---|--------------------------------|-------|-------|
| Toothbrush Style Utility Brushes | | | | |
| 40674 | 7" Plastic Handle with .5" Nylon Bristles | Tile/General Purpose | 00 | 12 ea |
| 40675 | 7" Plastic Handle with .5" Stainless Steel Bristles | Ovens/Grills/Small tough areas | 00 | 12 ea |
| 41270 | 7" Plastic Handle with .5" Brass Bristles | Ovens/Grills/Small tough areas | 00 | 12 ea |
| Butcher Block Brushes | | | | |
| 40676 | 4" x 9" Brush with Flat Steel Bristles | Butcher Block | 00 | 12 ea |
| 45781 | 2.63" x 7.75" Brush with Steel Bristles | Butcher Block | 00 | 12 ea |
| Meat Slicer Cleaning Tool | | | | |
| 40728 | Meat Slicer Cleaning Tool | Meat Slicer Blade | 25 | 12 ea |
| 40729 | Meat Slicer Scrub Pad | Meat Slicer Blade | 08 | 12 pk |

DISHWARE CLEANING

Scrubs & Sponges

- 36752 is a long-lasting 400 series stainless that won't rust or splinter
- 36396: aggressive pad for use in place of steel wool – not recommended for coated cookware, soft plastics, fine china or polished stainless steel as scratching can occur

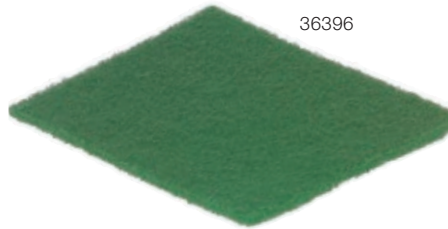

Dish Brushes

- 40413 has a 180° brush head and full end bristles to prevent splash back when in use cleaning dishes, utensils and fry pans
- 3610140 is perfect for scraping off food before placing in dishwasher



| Prod No | Description | Recommended Cleaning | Color | Pack |
|-----------------------------|--|----------------------|-------|-------|
| Scrubs & Sponges | | | | |
| 36396 | 9" x 6" x .25" Medium Duty Scour Pad 10 ea/pack, 6 packs/case | Pots/Pans/Equipment | 08 | 6 ea |
| 36752 | 35 g Stainless Steel Scrub, 400 Series 12 ea/pack, 6 packs/case | Pots/Pans/Oven | 00 | 6 ea |
| 365501 | 8.25" x 4.25" x 2.25" Extra Large Sponge | Dishes | 00 | 24 ea |
| Dish Brushes | | | | |
| 40413 | 12" Handle Dish Brush with Polyester Bristles, 2.75" trim | Dishes/Utensils | 00 | 12 ea |
| 367600TC | 11" Handle Dish Brush with Polyester Bristles, 2.75" trim | Dishes/Utensils | 02 | 6 ea |

EQUIPMENT CLEANING

Oven & Grill Brushes

- Wire brushes and stainless steel metal scrapers make quick and easy removal of heavy carbon deposits, rust and burned-on food build up

Broiler Master

The best grill brush available and master of all grill cleaning tools. Rust-proof bristles are embedded in a rugged specially treated hardwood block for long-lasting cleaning power.



Double Broiler King 40294

- Sturdy construction with two heads featuring carbon steel flat bristles on one side and carbon steel wire bristles on the other; bolted together on a heavy hardwood handle for very heavy use

Oven Brush 41520 & 40291

- Crimped brass wire bristles and a full length stainless steel scraper for cleaning high-temperature stack ovens

Oven Brush 40293

- Crimped brass wire bristles and a full length aluminum scraper on a low-profile head for cleaning the narrow spaces inside pizza ovens

Pizza/BBQ Oven Brush 45772

- Steel wire bristles and permanent 39" hardwood handle

Oven & Grill Brush 363725

- Flat wire stainless steel bristles, oven scraper and 30" handle



40291



40293



363725



TOP SELLER



40290



45772



40294

Standard(00)

| Prod No | Description | Color | Pack |
|---------------------------------|--|-------|-------|
| Oven & Grill Brushes | | | |
| 40026 | 8.5" Broiler Master Brush, Carbon Steel Bristles with 30" Handle | 00 | 6 ea |
| 40290 | 8.5" Broiler Master Brush, Stainless Steel Bristles with 30" Handle | 00 | 6 ea |
| 40294 | 8" Double Broiler King, Carbon Steel Flat & Wire Bristles with 48" Handle | 00 | 2 ea |
| 41520 | 8.5" Oven Brush & Scraper, Brass Wire Bristles with 42" Handle | 00 | 1 ea |
| 40291 | 8.5" Oven Brush & Scraper, Brass Wire Bristles (Head Only) | 00 | 12 ea |
| 40293 | 10" Oven Brush & Scraper, Brass Wire Bristles (Head Only) | 00 | 12 ea |
| 45772 | 5.5" Pizza/BBQ Oven Brush, Carbon Steel Bristles and 33" Handle | 00 | 12 ea |
| 363725 | 8" Oven Brush with Scraper, Flat Wire Stainless Steel Bristles with 30" Handle | 00 | 1 ea |

NOTE: Equipment must be turned off prior to using Oven & Grill Brushes

*40291 & 40293 do not include handles; use with handle 40275 shown on page 295

Grill Bricks, Screens & Polishing Pads

- Apply with cooking oil to protect the grill, cure and remove excess cooked-on foods
- 40710 Grill Brick is a fast, efficient and sanitary way to clean hot or cold grills
- Plastic wrapping on Grill Brick dissolves to eliminate mess
- 40713 Grill Screen and 40711 Grill Polishing Pad attach to the 40712 Grill Pad Holder for a complete grill maintenance system



40710



40711



40712
40713
40711

Scratch Brushes

- Compact profile for heavy scraping and cleaning in tight, narrow spaces; provides quick, aggressive removal of grease and deposits
- Available with wood handles for cleaning hot grills and ovens
- Available in nylon, stainless steel or carbon steel wire bristles for normal to tougher cleaning jobs



Standard(00)



45779

40671

40670

40672

40027

45571

| Prod No | Description | Handle | Color | Pack |
|---|---|---------|-------|--------|
| Grill Bricks, Screens & Polishing Pads | | | | |
| 40710 | 3.5" x 4" x 8" Grill Brick | — | 00 | 12 ea |
| 40711 | 4" x 5" x .25" Grill Polishing Pads, 10 ea/pack, 6 pks/case | — | 00 | 6 pks |
| 40712 | Grill Pad Holder | Plastic | 00 | 10 ea |
| 40713 | 4" x 5.5" Grill Screen, 20 ea/pack, 10 pks/case | — | 00 | 10 pks |
| Scratch Brushes | | | | |
| 45779 | 11" Brush & Scraper with Carbon Steel Bristles | Wood | 00 | 12 ea |
| 40671 | 11.5" Scratch Brush & Scraper with Carbon Steel Bristles | Plastic | 00 | 12 ea |
| 40670 | 11.5" Scratch Brush with Carbon Steel Bristles | Plastic | 00 | 12 ea |
| 40672 | 11.5" Scratch Brush & Scraper with Stainless Steel Bristles | Plastic | 00 | 12 ea |
| 40027 | 11.5" Scratch Brush with Nylon Bristles | Plastic | 00 | 12 ea |
| 45571 | 20" Brush & Scraper with Carbon Steel Bristles | Wood | 00 | 12 ea |

NOTE: Equipment must be turned off prior to using Scratch Brushes

HAND & NAIL

Reduce the risk of foodborne illness breakouts with our hand & nail brushes. Every wash station in a foodservice operation should have a Carlisle Hand & Nail Brush.

Hand & Nail Brushes

- Designed to promote vital cleansing of hands for foodservice personnel
- 40020 has stiffer center bristles for a more thorough cleaning under fingernails and longer bristles along the sides clean finger's top and bottom
- 40021 kit includes 5" x 2" brush, cord to secure brush in place, hanging hook and an adhesive backed hand washing instructions decal in English and Spanish



36239



40021



40020



Standard(00)

| Prod No | Description | Recommended Cleaning | Color | Pack |
|--------------------------------|--|----------------------|-------|-------|
| Hand & Nail Brushes | | | | |
| 36239 | 3.5" Plastic Block Hand & Nail Brush | Hands & Nails | 00 | 24 ea |
| 40020 | 5" Handle Hand & Nail with Polyester Bristles | Hands & Nails | 00 | 12 ea |
| 40021 | 5" Handle Hand & Nail Brush Kit | Hands & Nails | 00 | 12 ea |
| 40022 | 36" Replacement Coiled Vinyl Security Line | — | 00 | 12 ea |
| 40023 | Replacement Hook only for Hand & Nail Brush Pack | — | 00 | 12 ea |

SCRUB BRUSHES

All Purpose Utility Scrub Brushes

- Brushes offer a thick “pistol grip” block handle and short, stiff bristles for really tough cleaning
- Light-weight, break-resistant, “soak-proof” plastic handles are perfect for clean up in a foodservice environment
- Rugged construction with stapleset secure bristles
- Full color-coded products offer easy identification for tool segregation



| | | | | |
|--------------|-----------|------------|------------|------------|
| Standard(00) | White(02) | Black(03) | Yellow(04) | Red(05) |
| Green(09) | Blue(14) | Orange(24) | Tan(25) | Purple(68) |

| Prod No | Description | Recommended Cleaning | Color | Pack |
|--|--|---------------------------|--------------------------------|-------|
| All Purpose Utility Scrub Brushes | | | | |
| 40541 | 8" Utility Scrub Brush with Polyester Bristles, 2" trim | Pots/Pan/Medium Scrubbing | 02, 04, 05, 09, 14, 24, 25, 68 | 12 ea |
| 40501 | 20" Utility Scrub Brush with Polyester Bristles, 2" trim | Pots/Pan/Medium Scrubbing | 02, 03, 05*, 14*, 24, 25, 68 | 12 ea |
| 40501C | 20" Color-Coded, Polyester Utility Scrub Brush Polyester Bristles, 2" trim | Pots/Pan/Medium Scrubbing | 02, 04, 05, 09, 14 | 6 ea |
| 40545 | 8" Brush with Medium Stiff Polyester Bristles, 1.6" trim | Pots/Pan/Medium Scrubbing | 00 | 12 ea |
| 40546 | 8" Brush with Medium Stiff Polyester Bristles, 1.6" trim | Pots/Pan/Medium Scrubbing | 02 | 12 ea |
| 40542 | 8" Brush with Medium Stiff Nylon Bristles, 1.4" trim | Pots/Pan/Medium Scrubbing | 00 | 12 ea |
| 40500 | 20" Brush with Medium Stiff Nylon Bristles, 1.6" trim | Pots/Pan/Medium Scrubbing | 00 | 12 ea |

*Color available by special order only

GENERAL CLEANING BRUSHES

General Clean-Up Brushes

- 45463, 45493 have hardwood block design with stiff palmyra bristles for heavy-duty scrubbing
- Light-weight plastic handles are break-resistant, soak-proof, sanitary and economical.



Natural Fiber Bristles

- 45463, 45493 have solid hardwood blocks
- 8" & 20" utility scrub brushes available with palmyra or tampico bristles



| Prod No | Description | Recommended Cleaning | Color | Pack |
|---|--|---------------------------|------------|-------|
| Clean-Up Brushes | | | | |
| 365015 | 6" Brush with Polypropylene Bristles, 1.38" trim | Pots/Pan/Medium Scrubbing | 00 | 12 ea |
| 36505 | 8.5" Brush with Polypropylene Bristles, 2" trim | Pots/Pan/Medium Scrubbing | 00, 01, 14 | 12 ea |
| 36505L | 20" Brush with Polypropylene Bristles, 2" trim | Pots/Pan/Medium Scrubbing | 00, 14 | 12 ea |
| Natural Fiber Bristle Utility Scrubs | | | | |
| 36509L | 20" Utility Scrub with Tampico Bristles | General Cleaning | 00 | 12 ea |
| 36513 | 8" Utility Scrub with Palmyra Bristles | General Cleaning | 00 | 12 ea |
| 36513L | 20" Utility Scrub with Palmyra Bristles | General Cleaning | 00 | 12 ea |
| 45463 | 8-1/2" Stiff Utility Scrub with Palmyra Bristles | Wok/Griddle | 00 | 12 ea |
| 45493 | 20" Stiff Utility Scrub with Palmyra Bristles | Wok/Griddle | 00 | 12 ea |

COUNTER & RADIATOR BRUSHES

Counter Top & Radiator Brushes

- Wide variety of bristle and handle choices
- 36211's flagged bristles are ideal for cleaning up fine particles and dust
- 45411 .5" Narrow Profile Radiator Brush cleans counter tops, between equipment and counter tops and refrigerated cooling coils



| | | | | | |
|--------------|-----------|-----------|-----------|------------|------------|
| Standard(00) | Brown(01) | White(02) | Black(03) | Yellow(04) | |
| Red(05) | Green(09) | Blue(14) | Gray(23) | Orange(24) | Purple(68) |

| Prod No | Description | Recommended Cleaning | Color | Pack |
|---|---|------------------------|--------------------------------|-------|
| Counter Top & Radiator Brushes | | | | |
| 40480 | 8" Plastic Handle with White Polyester Bristles, 2.5" trim | Counters/Tables | 01, 02, 04, 05, 09, 14, 24, 68 | 12 ea |
| 40481 | 8" Plastic Handle with Black Polyester Bristles, 2.5" trim | Counters/Tables | 00 | 12 ea |
| 40485 | 8" Wood Handle with Horsehair & Polypropylene Blend Bristles, 2.5" trim | Counters/Tables | 00 | 12 ea |
| 36211 | 8" Plastic Counter Brush, 2.5" trim | Counters/Tables | 23, 24 | 12 ea |
| 45411 | 24" Radiator Brush with Horsehair-Polypropylene Bristles, 2" trim | Radiators/Narrow Areas | 03 | 12 ea |

CLEANING CLOTHS & DUSTERS

Microfiber Cleaning/Polishing Cloths

- 36333 is great for mirrors, windows and metallic surfaces
- 36334 is great for general cleaning



Dusters

- 363404 features soft bristles for wall and ceiling dusting
- 45733 and 363156 duster have static active 100% lambswool; lambswool is electrostatically charged to attract lint and dust particles



| Prod No | Description | Recommended Cleaning | Color | Pack |
|---|--|------------------------|--------------------|-------|
| Microfiber Cleaning/Polishing Cloths | | | | |
| 36333 | 16" x 16" Microfiber Suede Polishing Cloth | Glass/Metalic Surfaces | 14 | 12 ea |
| 36334 | 16" x 16" Microfiber Terry Polishing Cloth | General Cleaning | 02, 04, 05, 09, 14 | 12 ea |
| Dusters | | | | |
| 363404 | 9" Flagged Polypropylene Duster | Walls/Ceilings | 14 | 12 ea |
| 365450 | 34" – 59" Metal Telescopic Handle | Attach to 363404 | 00 | 12 ea |
| 45733 | 30" – 42" Telescopic Plastic Handle with Lambswool | Vents/Blinds | 00 | 12 ea |
| 363156 | 52" – 81" Telescopic Poly Wool Duster | Vents/Blinds | 00 | 12 ea |

HAND SQUEEGEES, SCRAPERS & DUSTERS

Hand Held Window Squeegees

- Double blade red thermal rubber blades and zinc plated steel frame yields superior performance at an affordable price
- Single blade, black special blend rubber for a streak free professional finish. Zinc plated steel frame with a long handle socket that is easy to hold and fits a tapered handle

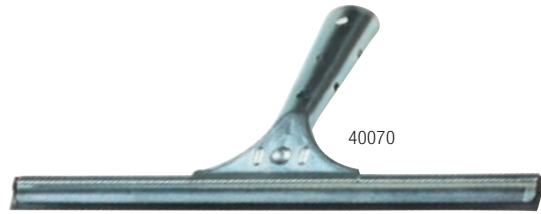

Window Scrapers

- Professional 4" wide scrapers
- 4" scraper has one sharp edge and one dull edge



| Prod No | Description | Recommended Cleaning | Color | Pack |
|-----------------------------------|--|-----------------------|-------|--------|
| Hand Held Window Squeegees | | | | |
| 41027 | 12" Double-Blade with Metal Handle | Windows | 00 | 6 ea |
| 40074 | 14" Double-Blade with Metal Handle | Windows | 00 | 12 ea |
| 40070 | 12" Single-Blade with Metal Handle | Windows | 00 | 12 ea |
| 40071 | 16" Single-Blade with Metal Handle | Windows | 00 | 12 ea |
| Window Scrapers | | | | |
| 365117 | Complete Scraper with 6" Plastic Handle Head & Blade | Tables/Floors/Windows | 00 | 10 ea |
| 365120 | 4" Replacement Blade Dispenser 10 per pack/10 packs per case | — | 00 | 10 pks |

HANDLE GUIDE

| Prod No | Page | Description | Type of Handle | Recommended Handle |
|--------------------------|------|---------------------------|----------------|--------------------|
| Equipment Brushes | | | | |
| 40291 | 268 | 8.5" Oven Brush & Scraper | Threaded | 40275 |
| 40293 | 268 | 10" Pizza Oven Brush | Threaded | 40275 |
| Hand Squeegees | | | | |
| 40070 | 275 | 12" Single-Blade Squeegee | Tapered | 365408 |
| 40071 | 275 | 16" Single-Blade Squeegee | Tapered | 365408 |
| 40074 | 275 | 14" Double-Blade Squeegee | Tapered | 365408 |
| 41027 | 275 | 12" Double-Blade Squeegee | Tapered | 365408 |



CARLISLE
FOODSERVICE PRODUCTS

DURABLE
INNOVATIVE
VERSATILE
**FLOOR &
RESTROOM
PRODUCTS**

Carlisle offers durable, innovative and versatile solutions to maintain a clean and healthy environment with a complete line of brushes, brooms and mopping supplies.



UPRIGHT BROOMS

Carlisle's upright brooms are **designed for extended use and offer superior performance.** Whether you're sweeping a lobby, kitchen floor or parking lot, we have **a high quality solution for you.**



Duo-Sweep® Angled

- For reaching into corners, along walls and into hard to reach areas
- Block made with tough & durable material that resists cracking, splitting and chipping
- Color coded angle brooms have one handle hole making them more hygienic and HAACP compliant
- Standard color (00) angle brooms have two handle holes; one angled, one upright

Recycled Angle Broom

- Contains 80% recycled flagged PET bristles and 60% recycled polypropylene copolymer shroud for increased stability
- Includes 48" durable vinyl coated metal handle with swivel hanging cap for storage



Standard Bristles
41083

Flagged Bristles
41082

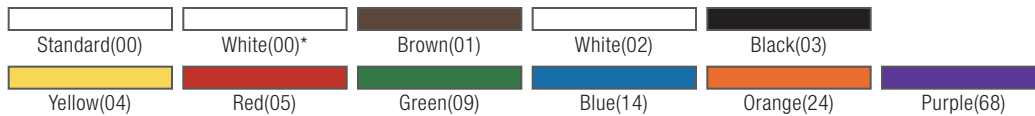

| Prod No | Description | Bristle Length | Color | Pack |
|---|--|----------------|--------------------------------|-------|
| Flagged Duo-Sweep Angle Brooms | | | | |
| 36861 | 6.5" Flagged Duo-Sweep Angle Broom with 30" Metal Handle | 5.5" - 7" | 00 | 12 ea |
| 36865 | 12" Flagged Duo-Sweep Medium Duty Angle Broom with 48" Metal Handle | 5.5" - 7" | 00 | 12 ea |
| 41082 | 12" Flagged Duo-Sweep Broom with 48" Fiberglass Handle | 5.5" - 7" | 01, 02, 04, 05, 09, 14, 24, 68 | 12 ea |
| 36867 | 12" Flagged Duo-Sweep Angle Broom – (Head Only) | 5.5" - 7" | 00, 01, 02, 04, 05, 09, 14, 24 | 12 ea |
| Unflagged Duo-Sweep Angle Brooms | | | | |
| 36885 | 12" Unflagged Duo-Sweep Heavy Duty Angle Broom with 48" Metal Handle | 5.5" - 7" | 00 | 12 ea |
| 41083 | 12" Unflagged Duo-Sweep Broom with 48" Fiberglass Handle | 5.5" - 7" | 01, 02, 04, 05, 09, 14, 24, 68 | 12 ea |
| 36868 | 12" Unflagged Duo-Sweep 12" Angle Broom (Head Only) | 5.5" - 7" | 01, 02, 03, 04, 05, 09, 14 | 12 ea |
| Replacement Handles | | | | |
| 41225 | 48" Fiberglass Handle with Self-Locking Flex™ Tip – 1" D | — | 00*, 01, 03, 04, 05, 09, 14 | 12 ea |
| 3620294 | 48" Plastic Coated Metal Threaded Handle – 15/16" D | — | 03 | 12 ea |
| 3620194 | 48" Powder Coated Metal Threaded Handle – 7/8" D | — | 14 | 12ea |
| Recycled Angle Broom | | | | |
| 40650 | 12" Flagged Recycled Angle Broom with 48" Steel Handle | 6" - 7" | 00 | 12 ea |



Flagged

Great for fine debris and use on smooth surfaces



Unflagged

Great for larger debris and rough surfaces: Bristles prevent ends from matting making this style perfect for back-of-house and outdoor applications

Duo-Sweep® Straight

- Two handle holes; upright hole for general purpose sweeping or angle hole for reaching into corners, along walls or into hard to reach areas
- Flagged blue synthetic bristle for fine debris
- Stiff black synthetic bristles can be easily cleaned to extend broom life
- Guaranteed to outlast up to four corn brooms



| Prod No | Description | Bristle Length | Color | Pack |
|-----------------------------------|---|----------------|------------------------|-------|
| Flagged Duo-Sweep Brooms | | | | |
| 36859 | 7.5" Flagged Duo-Sweep Lobby Broom with 30" Black Metal Handle | 4" | 14 | 12 ea |
| 36863 | 11" Flagged Duo-Sweep Light Industrial Broom with 48" Blue Metal Handle | 4" | 14 | 12 ea |
| 36853 | 11" Flagged Duo-Sweep Light Industrial Broom (Head Only) | 4" | 14 | 12 ea |
| 36883 | 13" Flagged Duo-Sweep Warehouse Broom with 48" Blue Metal Handle | 7" | 14 | 12 ea |
| 36873 | 13" Flagged Duo-Sweep Warehouse Broom (Head Only) | 7" | 14 | 12 ea |
| Unflagged Duo-Sweep Brooms | | | | |
| 36860 | 7.5" Unflagged Duo-Sweep Lobby Broom with 30" Black Metal Handle | 4" | 03 | 12 ea |
| 36864 | 11" Unflagged Duo-Sweep Light Industrial Broom with 48" Blue Metal Handle | 4" | 03 | 12 ea |
| 36854 | 11" Unflagged Duo-Sweep Light Industrial Broom (Head Only) | 4" | 03 | 12 ea |
| 36884 | 13" Unflagged Duo-Sweep Warehouse Broom with 48" Black Metal Handle | 7" | 03 | 12 ea |
| 36874 | 13" Unflagged Duo-Sweep Warehouse Broom (Head Only) | 7" | 03 | 12 ea |
| Replacement Handles | | | | |
| 41225 | 48" Fiberglass Handle with Self-Locking Flex™ Tip – 1" D | — | 00, 03, 04, 05, 09, 14 | 12 ea |
| 3620294 | 48" Plastic Coated Metal Threaded Handle – 15/16" D | — | 03 | 12 ea |
| 3620194 | 48" Powder Coated Metal Threaded Handle – 7/8" D | — | 14 | 12ea |

UPRIGHT BROOMS

Natural Corn Blend

- Heavy-duty lacquered wood handle
- 41354 heavy-duty warehouse broom has metal retaining bands and strong synthetic stitching for long-lasting use
- 41350 janitor broom has wide fan head for greater reach



100% Natural Corn

- Long lasting, durable broomcorn
- Heavy-duty lacquered wood handle



| Prod No | Description | Stitch | Color | Pack |
|----------------------------------|---|--------------|-------|-------|
| Natural Corn Blend Brooms | | | | |
| 36633 | 10" Corn Whisk | 2-Sew | 00 | 12 ea |
| 3682 | 40" Lobby Blended Corn Broom, 9# | 3-Sew | 00 | 12 ea |
| 41349 | 55" Housekeeping Broom | 3-Sew | 67 | 12 ea |
| 41352 | 55" Housekeeping Broom | 4-Sew | 00 | 12 ea |
| 41350 | 56" Warehouse/Janitor Blended Corn Broom, 29# | 5-Sew | 67 | 12 ea |
| 41354 | 56" Warehouse Blended Corn Broom, 30# | 4-Sew/1-Wire | 67 | 12 ea |
| 100% Natural Corn Broom | | | | |
| 40634 | 56" Janitor Corn Broom, 26# | 5-Sew | 00 | 6 ea |

Synthetic Corn

- “X” shaped polypropylene bristles allow for superior sweeping on carpeting and entry mats
- Chemical and liquid resistant bristles; sustains temperatures to 225°F
- All, except 36634, have wooden handle
- 41679 has a foam gripped handle
- 45643 and 45649 have metal top for added durability



| Prod No | Description | Stitch | Color | Pack |
|------------------------------|---------------------------------------|----------------|-------|-------|
| Synthetic Corn Brooms | | | | |
| 41679 | 57" Warehouse/Janitor Broom | 6-Sew | 03 | 12 ea |
| 41680 | 55" Housekeeping Broom | 5-Sew | 03 | 12 ea |
| 45649 | 54" Housekeeping Broom with Metal Top | Wire/Metal Top | 01 | 6 ea |
| 45643 | 48" Maid Broom with Metal Top | Wire/Metal Top | 04 | 12 ea |
| 41683 | 40" Toy/Lobby Broom | 3-Sew | 03 | 12 ea |
| 36634 | 9" Plastic Corn Whisk | 2-Sew | 00 | 12 ea |

FLOOR SWEEPS

Only Carlisle offers a broad range of high quality professional floor sweeps that are durable and versatile.

Our manufacturing and industry expertise provides advantageous features you can't find elsewhere.

Omni Sweep®

- Unique patented design combines the features of fine, medium and heavy floor sweeps in a convenient all-in-one design
- Effective on all types of floor surfaces
- Short, heavy bristles in front easily sweep up heavy debris
- Long, fine/medium bristles in back sweep fine dust and particles



Angled Pitch

Fast, effective sweeping



41881 with 40225 Handle

41880 with 40225 Handle

Sweep Complete™

- Versatile and durable floor sweep with built-in squeegee
- Comes with 60", 3-piece aluminum handle with brace
- Two handle holes extend the life of the sweep



36219618

Handles sold separately; see pages 310-311 for handle recommendation



| Prod No | Description | Bristle Length | Handle | Color | Pack |
|------------------------------------|--|----------------|----------|-------|-------|
| Omni Sweep – Plastic Block | | | | | |
| 41880 | 18" Omni Sweep | 1.63" - 2.38" | Threaded | 00 | 12 ea |
| 41881 | 24" Omni Sweep | 1.63" - 2.38" | Threaded | 00 | 12 ea |
| Sweep Complete Floor Sweeps | | | | | |
| 36219618 | 18" Sweep Complete Floor Sweep with Squeegee | 3" | Threaded | 14 | 6 ea |
| 36219624 | 24" Sweep Complete Floor Sweep with Squeegee | 3" | Threaded | 14 | 6 ea |

Fine

- Recommended use: Fine powder and dust removal on polished wood, marble, terrazzo or ceramic tile floors
- Heavy-duty plastic block resists splitting and cracking and is unaffected by moisture
- Soft, flagged bristles



36204824

Medium

- Recommended use: For general sweeping of smooth concrete, unpolished wood, vinyl and tile floors
- Heavy-duty plastic blocks resist splitting and cracking and are unaffected by moisture
- Horsehair polypropylene is a perfect blend of soft bristles for fine dust and stiff bristles for heavier debris
- Use black natural tampico bristles for heavy dirt
- Black polypropylene bristles resist oil and water while maintaining shape



40562

Handles sold separately; see pages 310-311 for handle recommendation



| Prod No | Description | Handle | Color | Pack |
|----------------------------|--|---------|-------|-------|
| Fine Floor Sweeps | | | | |
| 36204818 | 18" Foam Block with Gray Polypropylene, 3" trim | Tapered | 23 | 12 ea |
| 36204824 | 24" Foam Block with Gray Polypropylene, 3" trim | Tapered | 23 | 12 ea |
| Medium Floor Sweeps | | | | |
| 40564 | 18" Foam Block with Black Tampico, 3" trim | Tapered | 00 | 12 ea |
| 40565 | 24" Foam Block with Black Tampico, 3" trim | Tapered | 00 | 12 ea |
| 40561 | 18" Foam Block with Horsehair-Polypropylene Blend, 3" trim | Tapered | 00 | 12 ea |
| 40562 | 24" Foam Block with Horsehair-Polypropylene Blend, 3" trim | Tapered | 00 | 12 ea |
| 362208P18 | 18" Foam Block with Black Polypropylene, 3" trim | Tapered | 03 | 12 ea |
| 362208P24 | 24" Foam Block with Black Polypropylene, 3" trim | Tapered | 03 | 12 ea |

FLOOR SWEEPS

Heavy

- Recommended Use: Outdoors on rough surfaces such as sidewalks and parking lots
- For wet or dry sweeping
- Polypropylene (PPY) bristles are stiff and long lasting under harsh conditions. PPY bristles resist oil and water making them ideal for back-of-house cleaning
- Palmyra bristles are medium stiff and long lasting under harsh conditions
- Plastic blocks are extremely durable and resist water, cracking, splitting and chipping
- Wood blocks are made with natural lacquered hardwood

Plastic Block



36207218

Wood Block



45222

367624

367618

Handles sold separately; see pages 310-311 for handle recommendation



| Prod No | Description | Handle | Color | Pack |
|---------------------------|--|------------------|-------|-------|
| Heavy Floor Sweeps | | | | |
| 36207218 | 18" PPY Sweep, Foam Block, 3.25" trim | Tapered | 00 | 12 ea |
| | 24" PPY Sweep, Foam Block, 3.25" trim | Tapered | 00 | 12 ea |
| 45222 | 24" Palmyra Sweep with Hardwood Block, 3.5" trim | Threaded/Tapered | 00 | 12 ea |
| 367618 | 18" PPY Sweep, Hardwood Block, 3.25" trim | Threaded/Tapered | 24 | 12 ea |
| 367624 | 24" PPY Sweep, Hardwood Block, 3.25" trim | Threaded/Tapered | 24 | 12 ea |

DUSTPANS & SWEEPERS

Lobby Pan & Broom Combos

- Lobby pans and brooms with sectional handles to give you over 50% reduction in carton size; lower cube saves warehouse space and shipping costs
- The lobby pans pivot and lock into place during use and release for easy carrying or emptying
- Handles feature a pivoting hanging hole at top for storage

361415 Combo includes the following:

- Serrated edge allows you to comb the broom's bristles and drop debris into the pan
- Handy clip to attach broom for convenient storage
- 30" two-piece handle made from vinyl coated steel

361416 Combo includes the following:

- Adjustable position head for more functional use in corners and under counters or tables
- 3 piece, 30" handle
- Handy clip to attach broom for convenient storage
- Shelf-friendly packaging



Black(03)

| Prod No | Description | Material | Style | Color | Pack |
|-------------------------------------|--|----------|-------|-------|-------|
| Lobby Pan & Broom Combos | | | | | |
| 361415 | Duo-Pan™ Lobby Pan & Duo-Sweep Broom Combo | Plastic | Lobby | 03 | 1 ea |
| 361412 | Broom Handle Clip for 361415 | — | — | 03 | 12 ea |
| 361416 | Duo-Pan™ II Lobby Pan & Broom Combo | Plastic | Lobby | 03 | 4 ea |

DUSTPANS & SWEEPERS

Dust & Lobby Pans

- Dust Pans are available in metal or plastic as well as in a “flip-up” lobby style or hand held
- Dust pan (361437) features a 90° threaded handle hole to convert it to an economy lobby dustpan
- 361420 features a 2 piece handle which reduces the carton size saving warehouse space and shipping costs
- 361420 has plastic edged teeth on the bail which allows you to comb through broom bristles to remove debris



Floor Sweepers

- Brushless mechanical sweeper has non-marking rubber blades that grab fine particles and heavy debris from various types of floor surfaces
- Large capacity dust bins thoroughly clean blades as they rotate; won't re-deposit dirt like ordinary sweepers
- Easy one touch doors for emptying debris
- Shelf-friendly packaging



| Prod No | Description | Material | Style | Color | Pack |
|------------------------------|--|-------------------|-----------|-------|-------|
| Dust & Lobby Pans | | | | | |
| 361420 | 12" Wide Lobby Dust Pan with 2-Piece 30" Handle | — | Lobby | 03 | 1 ea |
| 361437 | 12" Wide Rubberized Plastic Dustpan | Plastic | Hand-Held | 03 | 24 ea |
| 36236 | 12" Metal Dustpan | Heavy Gauge Steel | Hand-Held | 03 | 12 ea |
| 361410 | 12" Duo-Pan™ Plastic Lobby Pan with 30" Metal Handle | Plastic | Lobby | 03 | 6 ea |
| 36141003-1 | 12" Duo-Pan™ Plastic Lobby Pan with 30" Metal Handle | Plastic | Lobby | — | 1 ea |
| Floor Sweepers | | | | | |
| 36399 | 9.5" Multi-Surface Sweeper | — | — | 14 | 4 ea |
| 36400 | 12" Multi-Surface Sweeper | — | — | 14 | 4 ea |

FLOOR SCRUB BRUSHES

Dual Surface Brushes

- Recommended use: Cleaning kitchen floors, under counters, around equipment and along baseboards
- Floor scrubs are made with three different brush surfaces for cleaning at different angles
- Non-absorbent plastic blocks and synthetic bristles wash easily and prevent gathering of mold and mildew



Scrub Brushes

- Recommended use: Cleaning kitchen floors, under counters, around equipment and along baseboards
- Polypropylene (PPY) bristles are stiff and long lasting under harsh conditions. PPY bristles resist oil and water making them ideal for back-of-house cleaning
- Tampico bristles provide durability and high resistance to solvents and heat
- Palmyra bristles are medium stiff and long lasting under harsh conditions
- Natural wood block



Handles sold separately; see pages 310-311 for handle recommendation

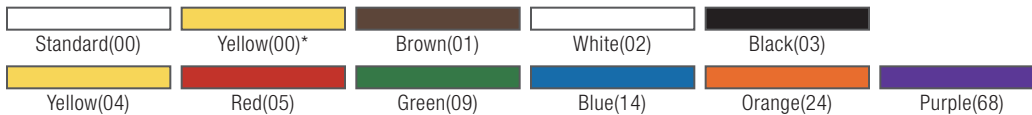

| Prod No | Description | Handle | Color | Pack |
|---------------------------------------|--|------------------|--------------------------------|-------|
| Dual Surface Brushes | | | | |
| 40423 | 10" Hi-Lo Floor Scrub Brush | Threaded | 01, 02, 03, 04, 05, 09, 24, 68 | 12 ea |
| 36197 | 10" Dual Surface Scrub Brush | Threaded | 14 | 12 ea |
| 36190 | 10" Dual Surface Scrub Brush with Squeegee | Threaded | 14 | 12 ea |
| 40422 | 10" Dual Surface Scrub Brush with End Bristles | Threaded | 00*, 05, 09, 14 | 12 ea |
| Floor & Deck Scrub Brushes | | | | |
| 36175 | 10" Wood Block with Stiff Polypropylene Bristles | Threaded/Tapered | 14 | 12 ea |
| 36275 | 12" Wood Block with Stiff Polypropylene Bristles | Threaded/Tapered | 14 | 12 ea |
| 36193 | 10" Wood Block with Tampico Bristles | Threaded/Tapered | 00 | 12 ea |
| 36192 | 10" Wood Block with Palmyra Bristles | Threaded/Tapered | 00 | 12 ea |
| 36292 | 12" Wood Block with Palmyra Bristles | Threaded/Tapered | 00 | 12 ea |

FLOOR SCRUB BRUSHES

Swivel Floor Brushes

- Patented* design swivels onto side to clean baseboards, walls, around kitchen equipment and other hard to reach areas

*U.S. Patent No. 4763377



Scrub Pads & Holder

- Swivel pad holder is great for cleaning baseboards, floor edges, underneath fixtures and ceramic tile



Handles sold separately; see pages 310-311 for handle recommendation



| Prod No | Description | Handle | Color | Pack |
|--------------------------------|---|----------|-------|-------|
| Swivel Floor Brushes | | | | |
| 365300* | 8" Heavy-Duty Daily Swivel Scrub with Nylon Grit Bristles | Threaded | 14 | 12 ea |
| 365310* | 8" Swivel Scrub with Heavy Nylon Grit Bristles | Threaded | 27 | 12 ea |
| 40430 | 9" All-Around Scrub Brush with Stiff Polypropylene Bristles | Threaded | 00* | 12 ea |
| 36219663 | 8" Polypropylene-Fill Swivel Scrub with 48" Handle | — | 00 | 4 ea |
| Scrub Pads & Holder | | | | |
| 40724 | 10" x 4-5/8" x 1" Nylon Fine Scrub Pad, 5 ea/pack, 4 pks/case | — | 00 | 4 pks |
| 40725 | 10" x 4-5/8" x 1" Nylon Medium Scrub Pad, 5 ea/pack, 4 pks/case | — | 00 | 4 pks |
| 365380 | Swivel Pad Holder | — | 14 | 12 ea |

GROUT BRUSHES & FLOOR SQUEEGEES

Tile & Grout Brushes

- 365320 has bevel cut stiff crimped nylon bristles and a swivel head for hard to reach areas
- 41323 features a molded in scraper for tough dirt and grime and can be hand held or used with a threaded handle. Base resins for block and bristles are FDA compliant



Double Foam Squeegees with Metal Frame

- Rugged black neoprene for heavy-duty removal of dirt, water and debris on uneven surfaces
- Medium flexibility and non-marking

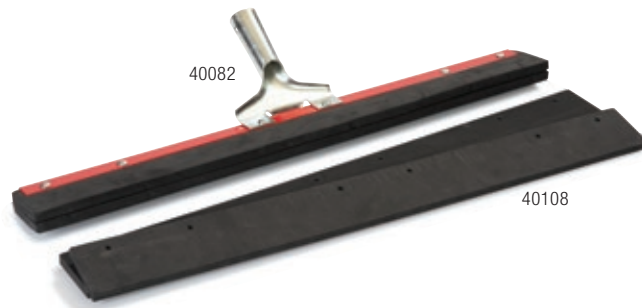

Handles sold separately; see pages 310-311 for handle recommendation

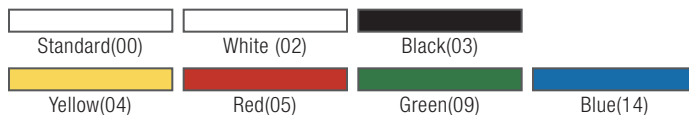

| Prod No | Description | Handle | Color | Pack |
|---|--|------------------|--------------------|-------|
| Tile & Grout Brushes | | | | |
| 365320 | 7.5" Swivel Head Grout Line Brush, Nylon Bristle | Threaded/Tapered | 03 | 12 ea |
| 365351 | 8.5" Grout Brush, Nylon Bristle | — | 03 | 24 ea |
| 41323 | 9" Tile & Grout Brush | Threaded | 02, 04, 05, 09, 14 | 12 ea |
| Double Foam Squeegees with Metal Frame | | | | |
| 40081 | 18" Double Foam Neoprene Rubber | 1.13" Tapered | 00 | 6 ea |
| 40082 | 24" Double Foam Neoprene Rubber | 1.13" Tapered | 00 | 6 ea |
| 40083 | 30" Double Foam Neoprene Rubber | 1.13" Tapered | 00 | 6 ea |
| 40107 | 18" Double Foam Neoprene Rubber Refill | — | 00 | 12 ea |
| 40108 | 24" Double Foam Neoprene Rubber Refill | — | 00 | 12 ea |
| 40109 | 30" Double Foam Neoprene Rubber Refill | — | 00 | 12 ea |

FLOOR SQUEEGEES

Double Moss Foam Rubber with Metal Frame

- Moss Foam squeegee is designed for uneven, grouted and smooth surface floors
- Red Moss Foam is fat and oil resistant



Double Foam Rubber Squeegee with Plastic Frame

- All plastic construction will not rust or bend and helps prevent hazard sparks when cleaning-up flammable fluids
- Available in colors to support HACCP compliance
- For uneven or smooth surfaces



Double Moss Foam Rubber Squeegee with Plastic Frame

- Soft, double foam is fat and oil resistant
- All plastic construction will not rust or bend and helps prevent hazard sparks when cleaning-up flammable fluids
- For uneven or smooth surfaces

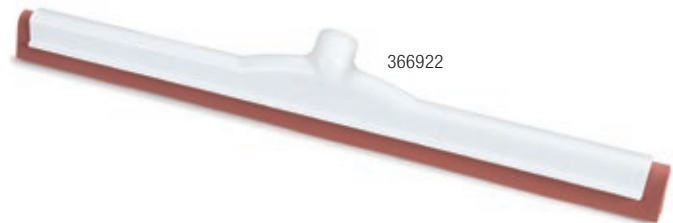

Handles sold separately; see pages 310-311 for handle recommendation

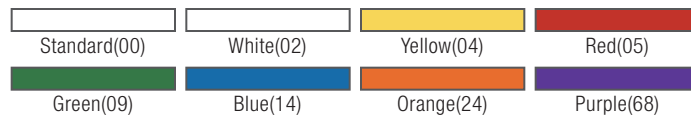

| Prod No | Description | Handle | Color | Pack |
|--|---------------------------------------|---------------|----------------------------|-------|
| Double Moss Foam Rubber with Metal Frame | | | | |
| 366318 | 18" Soft Black Foam Rubber | .94" Tapered | 00 | 10 ea |
| 366324 | 22" Soft Black Foam Rubber | .94" Tapered | 00 | 10 ea |
| 366824 | 22" Soft Black Heavy-Duty Foam Rubber | Threaded | 00 | 10 ea |
| 366330 | 30" Reinforced Soft Black Foam Rubber | .94" Tapered | 00 | 10 ea |
| Double Foam Rubber Squeegee with Plastic Frame | | | | |
| 41567 | 18" Double Foam Rubber Floor Squeegee | Threaded | 02, 04, 05, 09, 14, 24, 68 | 6 ea |
| 41568 | 24" Double Foam Rubber Floor Squeegee | Threaded | 02, 04, 05, 09, 14, 24, 68 | 6 ea |
| Double Moss Foam Rubber Squeegee with Plastic Frame | | | | |
| 366918 | 18" Red Foam Rubber | .94" Threaded | 00 | 10 ea |
| 366922 | 22" Red Foam Rubber | .94" Threaded | 00 | 10 ea |

Double Foam Rubber Squeegee & Brush with Plastic Frame

- Use the brush side to remove stubborn debris and the squeegee side to dry the floor
- All plastic construction will not rust or bend and helps prevent hazard sparks when cleaning-up flammable fluids

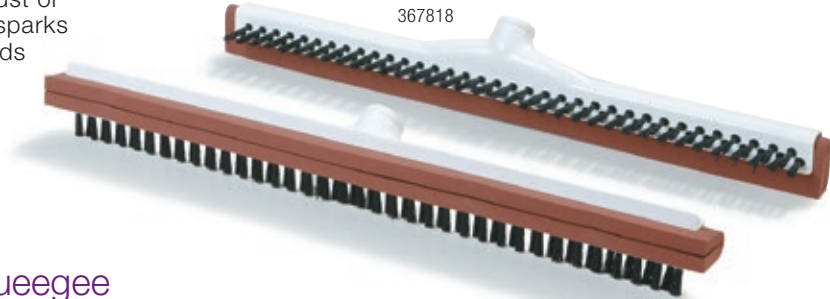

Curved End Rubber Squeegee with Metal Frame

- Single rubber blade design
- Curved end controls liquid better
- For smooth surfaces
- Red gum rubber is non-marking and durable for heavy-duty use



One-Piece Rubber Squeegee with Plastic Frame

- All plastic construction will not rust or bend and helps prevent hazard sparks when cleaning-up flammable fluids
- Available in colors to support HACCP compliance
- For smooth surfaces



Handles sold separately; see pages 310-311 for handle recommendation

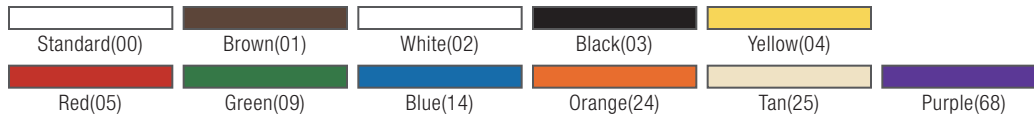

| Prod No | Description | Handle | Color | Pack |
|---|--------------------------------------|---------------|--|-------|
| Double Foam Rubber/Brush with Plastic Frame | | | | |
| 367818 | 18" Red Double Foam Red Rubber | Threaded | 00 | 10 ea |
| Single Curved End Rubber Squeegee with Metal Frame | | | | |
| 36324C | 24" Curved End Black Rubber Squeegee | 1.13" Tapered | 00 | 6 ea |
| 36336C | 36" Curved End Black Rubber Squeegee | 1.13" Tapered | 00 | 6 ea |
| One-Piece Rubber Squeegee with Plastic Frame | | | | |
| 36567 | 20" Solid, One-Piece Rubber Squeegee | Threaded | 01, 02, 03, 04, 05, 09, 14, 24, 25, 68 | 6 ea |
| 36568 | 24" Solid, One-Piece Rubber Squeegee | Threaded | 01, 02, 03, 04, 05, 09, 14, 24, 68 | 6 ea |

FLOOR SQUEEGEES

Straight Rubber Squeegee with Metal Frame

- Durable construction
- Non-marking single red gum rubber blade with medium flexibility
- Heavy duty steel frame with red powder coating



40076

VersaClean™ Brush & Squeegee

- It's a broom, scrub brush and squeegee all in one! Can be used on wet or dry surfaces
- Unique non-marking synthetic rubber bristles can build electrostatic charge to pick up hair or other light debris from soft or hard floor surfaces
- Durable bristles are excellent for scrubbing
- Dishwasher safe making it one of the most hygienic broom and brush options on the market
- Resists most chemicals and withstands temperatures up to 212°F



36596

36592



Squeegee cleans up wet surfaces quickly



Picks up light debris from carpet, rugs or bare floors



Use as an agitator for stubborn spots on tile or concrete



Built-in one-piece squeegee works on rough concrete surface

Handles sold separately; see pages 310-311 for handle recommendation



| Prod No | Description | Handle | Color | Pack |
|---|--------------------------------|---------------|-------|-------|
| Single Straight Rubber Squeegee with Metal Frame | | | | |
| 40075 | 18" Straight Red Gum Squeegee | 1.13" Tapered | 00 | 6 ea |
| 40076 | 24" Straight Red Gum Squeegee | 1.13" Tapered | 00 | 6 ea |
| 40077 | 36" Straight Red Gum Squeegee | 1.13" Tapered | 00 | 6 ea |
| VersaClean Brush & Squeegee | | | | |
| 36592 | VersaClean Brush with Squeegee | Threaded | 03 | 12 ea |
| 36596 | VersaClean Brush with Squeegee | Threaded | 03 | 12 ea |

HANDLES

Carlisle offers a **large selection of professional quality handles** that include fiberglass, plastic, metal, hardwood and telescoping.

Color-Coded Fiberglass Handles

- Durable for heavy usage
- For use with push brooms, sweeps, squeegees and floor scrubs
- Fiberglass handles are available in threaded, tapered/threaded and telescoping
- Self-Locking Flex-Tip Handle offers greater flexibility and reduces handle stress

Color-Coded Stainless Steel Handle

- Durable for heavy usage
- Color-Coded grip aligns with food safety (HACCP)
- Provide rigid stability
- Highly chemical resistant
- Standard threaded end

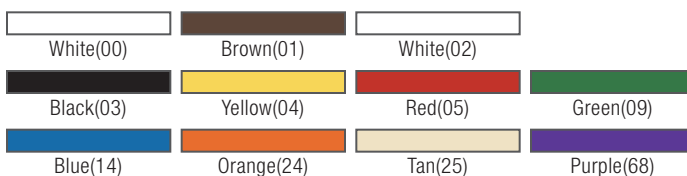

| Prod No | Description | Dia | Style | Color | Pack |
|---|--|------|----------------------|--|-------|
| Color-Coded Fiberglass Handles | | | | | |
| 41226 | 72" Fiberglass Handle with Self-Locking Flex-Tip | 1" | Threaded | 00 | 12 ea |
| 41225 | 48" Fiberglass Handle with Self-Locking Flex-Tip | 1" | Threaded | 00, 04, 05, 09, 14 | 12 ea |
| 41291 | 36" Fiberglass Handle with Self-Locking Flex-Tip | 1" | Threaded | 00 | 12 ea |
| 40225 | 60" Fiberglass Handle with Self-Locking Flex-Tip | 1" | Threaded | 01, 02, 03, 04, 05, 09, 14, 24, 25, 68 | 12 ea |
| 40227 | 60" Solid Foam Filled Fiberglass Handle with Self-Locking Flex-Tip | 1" | Tapered/Threaded | 02, 04, 05, 09, 14 | 12 ea |
| 40220 | 60" Fiberglass Handle | 1" | Tapered/Threaded | 01, 02, 04, 05, 09, 14 | 12 ea |
| 40210 | 60" Economy Fiberglass Handle | .94" | Female Threaded | 02, 04, 05, 09, 14 | 12 ea |
| 41020 | 54" to 8' Threaded Telescoping Fiberglass Handle | 1" | Threaded Telescoping | 01*, 02, 04, 05, 09, 14 | 12 ea |
| Color-Coded Stainless Steel Handle | | | | | |
| 41199C | 60" Stainless Steel Handle with Grip | 1" | Threaded | 02, 04, 05, 09, 14 | 6 ea |

FIBERGLASS

STAINLESS STEEL



*Color available by special order only

HANDLES



STEEL

METAL

PLASTIC

TELESCOPIC

Steel Handles

- Heavy-duty stainless steel handles are highly chemical resistant
- For use with caustic chemicals or in a sanitary food processing environment
- Highly durable alternative to fiberglass

Coated Metal Handles

- Lightweight and economical
- Plastic hanging cap

Plastic Handles

- A variety of sizes with reinforced threaded tip
- For light usage

Telescopic Handles

- Adjusts quickly to desired length
- Standard threaded end
- Ideal for window brushes and squeegees

3-Piece Aluminum Handle

- Utilizes metal y-connectors to secure sections
- Compact size saves on shipping costs
- Shelf-ready packaging

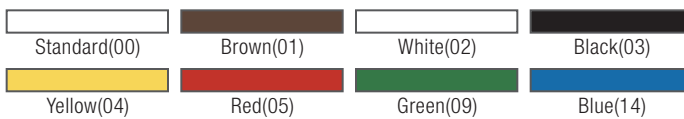

| Prod No | Description | Dia | Style | Color | Pack |
|--------------------------------|--|------|--|-------------------------|-------|
| Steel Handles | | | | | |
| 45259 | 60" Steel Handle | .94" | Threaded | 00 | 12 ea |
| Coated Metal Handles | | | | | |
| 3620194 | 48" Light Weight Powder Coated Metal Handle with Plastic Tip | .88" | Threaded | 14 | 12 ea |
| 3620294 | 48" Plastic Coated Metal Handle | .94" | Threaded | 03 | 12 ea |
| Telescopic Handles | | | | | |
| 365408 | 54" to 8' Aluminum Telescopic Handle with Locking Joints | 1" | European Tapered/ Standard Threaded | 00 | 10 ea |
| 41020 | 54" to 8' Fiberglass Telescopic Handle | 1" | Threaded | 01*, 02, 04, 05, 09, 14 | 12 ea |
| 3-Piece Aluminum Handle | | | | | |
| 40224 | 60" 3-Piece Aluminum Handle with Standard Thread | 1" | Threaded | 00 | 12 ea |
| Plastic Handles | | | | | |
| 40230 | 36" Plastic Handle with Reinforced Tip | 1" | Threaded | 00 | 12 ea |
| 40233 | 48" Plastic Handle with Reinforced Tip | 1" | Threaded | 00 | 12 ea |
| 40232 | 60" Plastic Handle with Reinforced Tip | 1" | Threaded | 00 | 12 ea |

*Color available by special order only

Wood Handles

- Made of lacquered hardwood
- Available in a large selection of standard threaded and tapered styles
- Economical choice

WOOD



Dust Mop Handles

- Available in wood, coated metal and fiberglass
- 360° movement for fast and easy cleaning

DUST MOP

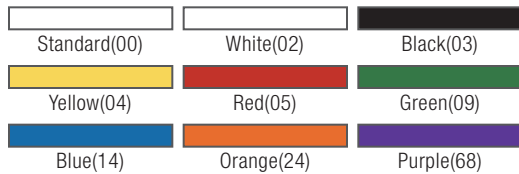
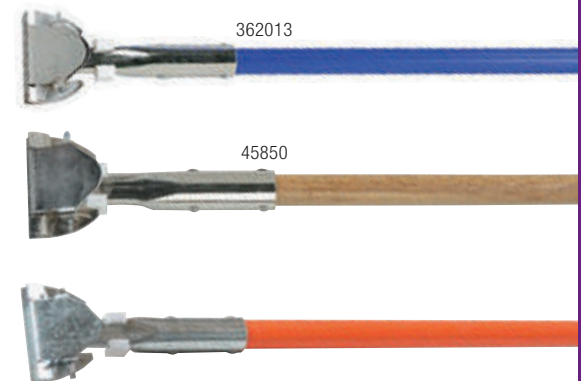

| Prod No | Description | Dia | Style | Color | Pack |
|------------------------------------|---|-------|--------------|---------------------------------|-------|
| Wood Threaded Handles | | | | | |
| 40271 | 60" Wood Handle | .94" | Threaded | 00 | 12 ea |
| 40267 | 60" Wood Handle | 1.13" | Threaded | 00 | 12 ea |
| Metal Threaded Handles | | | | | |
| 40275 | 40" Metal Tip Wood Handle | .88" | Metal Thread | 00 | 12 ea |
| 45267 | 60" Wood Handle with Metal Tip | .94" | Metal Thread | 00 | 12 ea |
| Tapered Handles | | | | | |
| 40261 | 54" Wood Handle | 1.13" | Tapered | 00 | 12 ea |
| 40262 | 60" Wood Handle | 1.13" | Tapered | 00 | 12 ea |
| Dust Mop Handles | | | | | |
| 45850 | 60" Wood Dust Mop Handle with Clip-On Connector | .94" | — | 00 | 12 ea |
| 362013 | 60" Vinyl Coated Metal Dust Mop Handle with Clip-On Connector | .94" | — | 00 | 12 ea |
| Fiberglass Dust Mop Handles | | | | | |
| 362113 | 60" Fiberglass Dust Mop Handle | 1" | — | 02, 03, 04, 05, 09, 14, 24, 68* | 12 ea |

*Color available by special order only

HANDLE ACCESSORIES

Roll 'N Grip™ Broom & Brush Holder System

- Adjustable rack holds a variety of different handle diameters
- Comes with a convenient hook for tools and brushes (additional hooks and grippers are available by special order)
- Rack anchor holes are 16" on center (mounting screws included)



Roll 'N Grip Plus

- Constructed of light-weight, durable ABS and rubber
- Fold-up hanging hooks for smaller items
- For use in temperatures from -4°F to 176°F
- Grips accommodate items from 5/8" - 1-1/4" in diameter and 0.4 - 8.25 lbs
- Hanging hooks can hold up to 1.5 lbs each



Color-Coded Brush Rack

- Heavy-gauge aluminum
- Extra deep (2-1/4") frame extends out from wall to allow brushes to hang with bristles facing the wall
- Holds up to 10 hanging tools
- Mounting holes are 16" on center (mounting screws included)
- Available in 5 colors to support HACCP compliance



| Prod No | Description | Color | Pack |
|---|---|---------------------|-------|
| Roll 'N Grip Broom & Brush Holder System | | | |
| 40731 | 18" Roll 'N Grip Broom & Brush Holder System | 00 | 12 ea |
| 40732 | Roll 'N Grip Replacement Roller (2 per pack) with 4 Wood Screws | 00 | 12 pk |
| 40733 | Roll 'N Grip Replacement Hooks (2 per pack) with 4 Wood Screws | 00 | 12 pk |
| Roll 'N Grip Plus | | | |
| 40737 | 16-1/2" Roll 'N Grip Plus Broom & Brush Holder | 00 | 24 ea |
| Color-Coded Brush Rack | | | |
| 40735 | 17" Brush Rack | 00*, 04, 05, 09, 14 | 12 ea |

MICROFIBER SYSTEM & DUST MOPS

Microfiber Dry Mop

- Looped end with microfiber center clings to dust like a magnet
- Quickly attaches itself to aluminum head
- Machine washable



Microfiber Wet Mop

- Dries quicker, cleans more thoroughly than a standard mop
- Machine washable and still effective with over 500 washings
- Quickly attaches itself to aluminum head



Aluminum Flat Mop Heads & Telescoping Handle For Microfiber

Mop Heads

- Heavy duty construction and swivel mechanism
- For use with wet and dry microfiber flat mops

Handle

- 70" telescopic handle for use with aluminum flat mop heads



Handles sold separately



| Prod No | Description | Handle | Color | Pack |
|--------------------------------|--------------------------------|---------|----------------|-------|
| Microfiber Dry Mops | | | | |
| 3633118 | 18" Microfiber Dry Mop Pad | 3633670 | 14 | 12 ea |
| 3633124 | 24" Microfiber Dry Mop Pad | 3633670 | 14 | 12 ea |
| 3633136 | 36" Microfiber Dry Mop Pad | 3633670 | 14 | 12 ea |
| Microfiber Wet Mops | | | | |
| 3633218 | 18" Microfiber Wet Mop Pad | 3633218 | 04, 05, 09, 14 | 12 ea |
| 3633224 | 24" Microfiber Wet Mop Pad | 3633218 | 14 | 12 ea |
| Aluminum Flat Mop Heads | | | | |
| 3633519 | 18" Aluminum Flat Mop Head | 3633670 | 00 | 12 ea |
| 3633525 | 24" Aluminum Flat Mop Head | 3633670 | 00 | 12 ea |
| 3633537 | 36" Aluminum Flat Mop Head | 3633670 | 00 | 12 ea |
| Telescoping Handle | | | | |
| 3633670 | 70" Aluminum Telescopic Handle | — | 00 | 12 ea |

MICROFIBER SYSTEM & DUST MOPS

Microfiber Charging Bucket

- Rectangular bucket with 6 gallon capacity
- Includes snap-on lid and clip-on plastic sleeve for window washers and squeegees
- Molded-in graduations
- Ergonomic handle for easy transportation



3633019

Tie Back Dust Mops & Frames

- An economical choice for a cotton dust mop with full tie back
- Frame is constructed of heavy gauge metal
- Zinc plating reduces rust and corrosion



3647524

41672

Wedge Dust Mop

- Cotton dust mop with frame
- Threaded handle hole
- For hard-to-reach areas



36490

Handles sold separately; see pages 310-311 for handle recommendation



| Prod No | Description | Handle | Color | Pack |
|--------------------------------------|-------------------------------------|------------------|-------|-------|
| Rectangular Microfiber Bucket | | | | |
| 3633019 | 6 gal Rectangular Microfiber Bucket | — | 23 | 3 ea |
| Value Line Tie Back Dust Mops | | | | |
| 3647524 | 24" Dust Mop, Fits 5" Wide Frame | — | 00 | 12 ea |
| 3647536 | 36" Dust Mop, Fits 5" Wide Frame | — | 00 | 12 ea |
| 3647548 | 48" Dust Mop, Fits 5" Wide Frame | — | 00 | 12 ea |
| Wedge Dust Mop | | | | |
| 36490 | Wedge Dust Mop | Threaded | 00 | 12 ea |
| 36490R | Wedge Mop Replacement | Threaded | 00 | 12 ea |
| Dust Mop Frames | | | | |
| 41672 | 24" Mop Frame, 5" Wide | Clip-On/Flexible | 00 | 12 ea |
| 41673 | 36" Mop Frame, 5" Wide | Clip-On/Flexible | 00 | 12 ea |
| 3647248 | 48" Mop Frame, 5" Wide | Clip-On/Flexible | 00 | 12 ea |

WET MOPPING GUIDE

Use the guide below to help choose the right products for your floor care needs.

General Mopping

Choose mops with high absorbency, release and durability. If laundering facilities are available, it is beneficial to take advantage of launderable mops to save money. For performance and durability choose a synthetic blend or rayon mop with looped end and woven tailbands.

Yarn

- It is important to choose the right mop in order to get maximum efficiency
- Some yarns naturally perform specific cleaning tasks better than others

Yarn Ply

- Yarn ply is the number of strands twisted together to make a single yarn strand
- Although more plies give added strength, it does not always mean higher quality yarn
- More strands can add durability, but they decrease absorbency
- It is better & more cost effective to choose a higher quality yarn than a high ply, low-quality yarn

Twist

- The “twist” of a yarn is a result of how tightly the fiber strands are wound together
- A tightly twisted yarn might have more strength & last longer, but it can have less absorbency
- The best choice is determined by the type & quality of the yarn, as well as the mop’s construction
- Mops with looped-end construction allow the yarn to have a loose twist without the fraying

Finish Mopping

For finish mopping applications look for a rayon or synthetic mop. These mops offer high absorbency and release. To make sure you are achieving maximum floor coverage with minimal streaking choose a tailband and looped end yarn.

| | Advantages | Disadvantages | Use |
|-------------------------------|--|--|--|
| Cotton | Good absorption & retention with limited shrinkage & a low initial cost. | Break-in period required. Slow drying yarn leads to mildew & deterioration. Lints. | Designed for general use. Scrubbing & cleaning up liquids. |
| Synthetic | Long stable fiber offers excellent tensile strength without linting. | Higher cost. Poor absorption. | Rough surfaces. |
| Cotton Synthetic Blend | Excellent choice for performance, price & durability. Synthetic fiber offers durability & color options. | Possible shrinkage. | Requested by professionals who require a better, longer lasting mop. |
| Rayon | Absorbs quickly with easy release. Dries fast & is mildew resistant. Cleaner yarn with less linting. | Shrinks when laundered and has less liquid retention. | Use for applying liquids such as disinfectant or floor finishes. |



Band Styles



Wide Band
Vinyl coated mesh – 5" width



Narrow Band
Textured polyester tape – 1.25" width



Screw Top
Textured polyester tape with a metal screw on attachment – 1.25" width

Handle — Jaw Style



Handle — Quick Change/Release



Handle — Screw In



WET MOPPING GUIDE

Use the guide below to help choose the right products for your floor care needs.

Cut-End Or Looped-End



Cut-End

- Cut-end mops are the most popular
- Low purchase price compared to looped end
- Cannot be laundered
- Cover less area per pass when mopping

Looped-End

- Superior performance and lasts longer than cut-end mops
- Launderable
- Tailband style gives better mopping coverage
- Looped-ends prevent fraying and unraveling so you can achieve reduced labor costs and replace mops less often
- Although the initial investment is more than a cut-end style, the life expectancy makes looped-end mops a more economical choice

How We Rate Our Mops

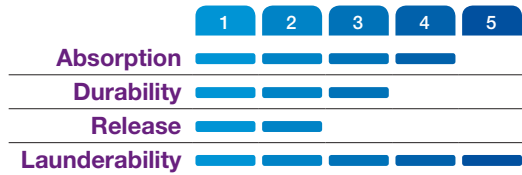

Absorbency

The absorbency of a mop refers to the ability to pick up and retain liquid. Higher levels allow faster floor drying times, leading to greater productivity and safety. Rayon and cotton yarns have the highest absorbency.

Durability

Mop durability is a measure of how long it will last or perform before needing replacement. Synthetic and blended mops are the most durable.

Release/Retention

Release is the ability of a mop to disperse liquid onto the floor or during wringing. Higher levels allow faster and more complete wringing, as well as more efficient application of cleaning solutions on the floor.

Launderability

The launderability is based on the number of washing cycles it can withstand before the construction of the mop is degraded. Synthetic and blended fiber mops have the highest levels of launderability.

Sizes Are Indicated By Tailband Color

Small



Medium



Large



X-Large



Brick Packs

Mops that are available in brick packs reduce cube up to 62%

(Item numbers ending with a "B" are sold in brick packs)



LOOPED END MOPS

Synthetic/Cotton Blend Looped-End

- Maximum Durability
- 50-75 uses per mop
- S, M and L are available in brick packs

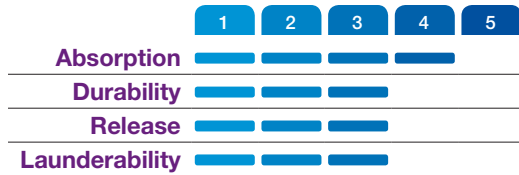

4 Ply Cotton Looped-End

- All purpose for general cleaning
- Packaged in brick packs

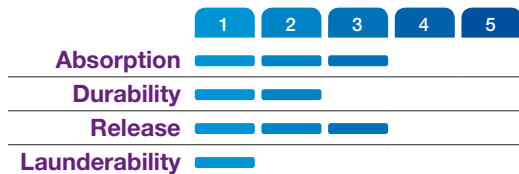

Handles sold separately; see pages 310-311 for handle recommendation



| Prod No | Description | Handle | Color | Pack |
|---|--|----------------------------|-------|-------|
| Synthetic/Cotton Blend (Wide Band) | | | | |
| 369412B | Small Yellow Wide Band Mop with White Yarn | Jaw Style | 00 | 12 ea |
| 369442B | Small Yellow Wide Band Mop with Blue Yarn | Jaw Style | 14 | 12 ea |
| 369472B | Small Yellow Wide Band Mop with Green Yarn | Jaw Style | 09 | 12 ea |
| 369418B | Medium Green Wide Band Mop with White Yarn | Jaw Style | 00 | 12 ea |
| 369448B | Medium Green Wide Band Mop with Blue Yarn | Jaw Style | 14 | 12 ea |
| 369478B | Medium Green Wide Band Mop with Green Yarn | Jaw Style | 09 | 12 ea |
| 369424B | Large Red Wide Band Mop with White Yarn | Jaw Style | 00 | 12 ea |
| 369454B | Large Red Wide Band Mop with Blue Yarn | Jaw Style | 14 | 12 ea |
| 369484B | Large Red Wide Band Mop with Green Yarn | Jaw Style | 09 | 12 ea |
| 369430 | X-Large Blue Wide Band Mop with White Yarn | Jaw Style | 00 | 12 ea |
| 369460 | X-Large Blue Wide Band Mop with Blue Yarn | Jaw Style | 14 | 12 ea |
| 4-Ply Cotton (Wide Band) | | | | |
| 369551B | Medium Green Band Looped-End Mop | Jaw Style | 00* | 12 ea |
| 369552B | Large Red Band Looped-End Mop | Jaw Style | 00* | 12 ea |
| 4 Ply Cotton (Narrow Band) | | | | |
| 369419B | Medium Green Band Looped-End Mop | Quick Release/Quick Change | 00* | 12 ea |
| 369425B | Large Red Band Looped-End Mop | Quick Release/Quick Change | 00* | 12 ea |

LOOPED END & CUT END MOPS

Microfiber Looped-End

- Microfiber mop combines the absorbency and durability of microfiber with conventional mop design and functionality
- Washable mop dries quickly and is still effective with 500 washings
- See pages 297-298 for a complete list of microfiber products

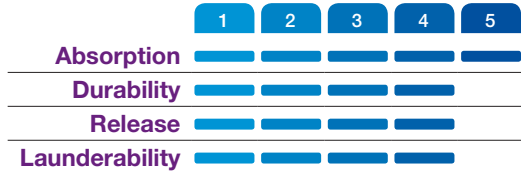

Rough Surface Looped-End

- 17 oz knitted fleece provides twice the absorbency of cotton yarn mops
- Excellent for abrasive surfaces: stone, quarry, tile and concrete

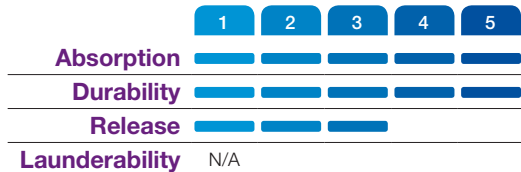

Rayon Blend Finishing Looped-End

- Durable 4-ply rayon blend has narrow band
- Releases liquid faster than a conventional mop for a smoother finish
- Brick packed

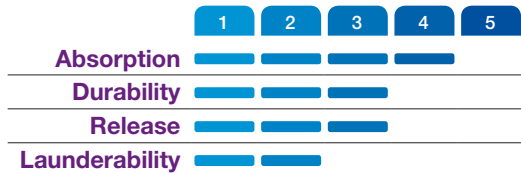

Handles sold separately; see pages 310-311 for handle recommendation



| Prod No | Description | Handle | Color | Pack |
|--|-------------------------------------|----------------------------|--------|-------|
| Microfiber (Wide Band) | | | | |
| 369420 | Medium Loop End Microfiber Mop | Jaw Style | 02, 14 | 12 ea |
| Rough Surface (Narrow Band) | | | | |
| 369320 | Medium Looped-End Rough Surface Mop | Quick Release/Quick Change | 00 | 12 ea |
| 4 Ply Rayon Blend Finishing (Wide Band) | | | | |
| 369670B | #20 Medium Finishing Looped-End Mop | Quick Release/Quick Change | 14 | 12 ea |
| 369674B | #24 Large Finishing Looped-End Mop | Quick Release/Quick Change | 14 | 12 ea |

4 Ply Cotton Cut-End

- Economical choice for general mopping
- Brick packed

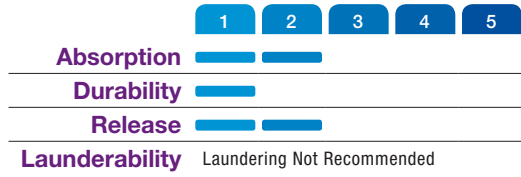

8 Ply Cotton Cut-End

- Abrasion-resistant, long lasting 8 ply cotton
- Best for general purpose cleaning

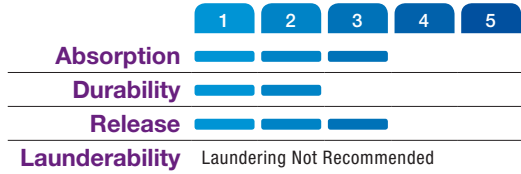

Handles sold separately; see pages 310-311 for handle recommendation

Standard(00)

| Prod No | Description | Handle | Color | Pack |
|-----------------------------------|-------------------------|----------------------------|-------|-------|
| 4 Ply Cotton (Narrow Band) | | | | |
| 369816B | #16 Small Cut-End Mop | Quick Release/Quick Change | 00 | 12 ea |
| 369820B | #20 Medium Cut-End Mop | Quick Release/Quick Change | 00 | 12 ea |
| 369824B | #24 Large Cut-End Mop | Quick Release/Quick Change | 00 | 12 ea |
| 369832 | #32 X-Large Cut-End Mop | Quick Release/Quick Change | 00 | 12 ea |
| 4 Ply Cotton (Wide Band) | | | | |
| 369811B | #16 Small Cut-End Mop | Jaw Style | 00 | 12 ea |
| 369814B | #20 Medium Cut-End Mop | Jaw Style | 00 | 12 ea |
| 369817B | #24 Large Cut-End Mop | Jaw Style | 00 | 12 ea |
| 369819B | #32 X-Large Cut-End Mop | Jaw Style | 00 | 12 ea |
| 8-Ply Cotton (Narrow Band) | | | | |
| 369724 | #24 Select Cut-End Mop | Quick Release/Quick Change | 00 | 12 ea |
| 369732 | #32 Select Cut-End Mop | Quick Release/Quick Change | 00 | 12 ea |

CUT END MOPS

4 Ply Rayon Cut End

- Easy to change mop heads lie flat for more efficient mopping
- 40345 Kwik-On wood handle (sold separately) attaches securely to Kwik-On mop head with a counter-sunk, reinforced thread



369074B

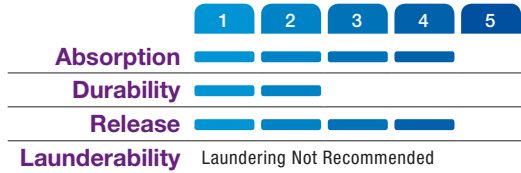

Kwik-On™ Screw Top

- Easy to change mop heads lie flat for more efficient mopping
- 40345 Kwik-On wood handle (sold separately) attaches securely to Kwik-On mop head with a counter-sunk, reinforced thread



369024R

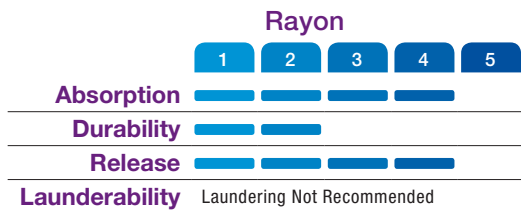
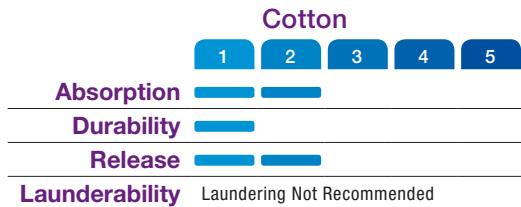

Handles sold separately; see pages 310-311 for handle recommendation



40345

Standard(00)

| Prod No | Description | Handle | Color | Pack |
|---|-----------------------------------|----------------------------|-------|-------|
| 4-Ply Rayon (Narrow Band) | | | | |
| 369066B | #16 Small Cut-End Mop | Quick Release/Quick Change | 00 | 12 ea |
| 369070B | #20 Medium Cut-End Mop | Quick Release/Quick Change | 00 | 12 ea |
| 369074B | #24 Large Cut-End Mop | Quick Release/Quick Change | 00 | 12 ea |
| 369082 | #32 X-Large Cut-End Mop | Quick Release/Quick Change | 00 | 12 ea |
| 4-Ply Cotton (Kwik-On Screw Top) | | | | |
| 369024C | #24 Kwik-On Cotton Mop | Kwik-On | 00 | 12 ea |
| 4-Ply Rayon (Kwik-On Screw Top) | | | | |
| 369024R | #24 Kwik-On Rayon Mop Head | Kwik-On | 00 | 12 ea |
| Kwik-On Handle | | | | |
| 40345 | 60" Kwik-On Handle 1.13" Diameter | — | 00 | 12 ea |

SPONGE MOPS & MOP HANDLES

Automatic Sponge Mop

- Recommended for mopping smooth surfaces
- Synthetic sponge head absorbs liquid fast

Ty-Dee™ Sponge Mop

- Recommended for mopping smooth surfaces
- Cellulose sponge head with non-corrosive metal parts and enameled wood handle



Jaw Style Mop Handles

- Use with wide band mops

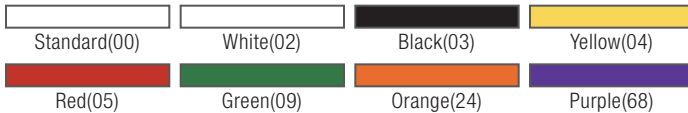
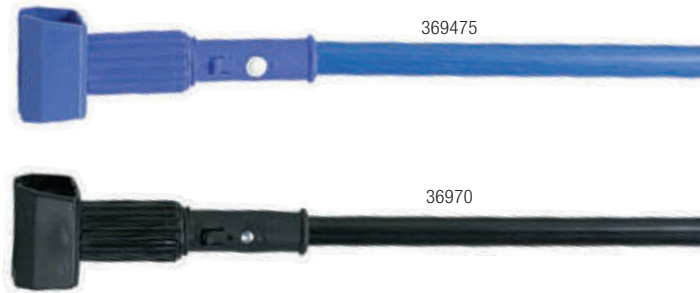

| Prod No | Description | Dia | Color | Pack |
|--|--|------|--------------------------------|-------|
| Automatic Sponge Mops – Aluminum Handle | | | | |
| 40300 | 8.5" Automatic Sponge Mop | — | 00 | 12 ea |
| 40301 | 12" Automatic Sponge Mop | — | 00 | 6 ea |
| 40305 | 8.5" Automatic Sponge Mop Refill | — | 00 | 12 ea |
| 40306 | 12" Automatic Sponge Mop Refill | — | 00 | 6 ea |
| Ty-Dee Sponge Mop – Enamel Wood Handle | | | | |
| 36990 | 9" Ty-Dee Sponge Mop with Built-in Wringer | — | 00 | 12 ea |
| 36990R | 9" Ty-Dee Refill | — | 00 | 12 ea |
| Jaw Style Mop Handles | | | | |
| 369475 | 60" Fiberglass Mop Handle | 1" | 00, 02, 03, 04, 05, 09, 24, 68 | 12 ea |
| 36970 | 60" Vinyl Coated Metal Mop Handle | .94" | 00 | 12 ea |

MOP HANDLES

Quick-Release Mop Handles

- 60" durable fiberglass
- Flexible plastic head with hinged gripper bites into any size mop band
- Releases mop head quickly; employees never need to touch a dirty mop head



Quick Change Handles

- Use with narrow band mops
- Plastic head with thumb wheel clamps mop in place
- Metal heads feature standard wing nut construction with a quick release cross bar

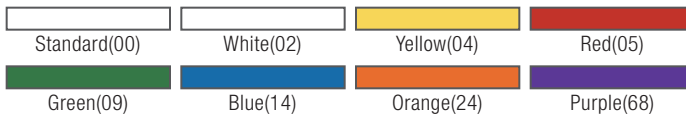

| Prod No | Description | Dia | Color | Pack |
|---|---|-------|----------------------------|-------|
| Color-Coded Quik-Release Mop Handle | | | | |
| 41664 | 60" Fiberglass Mop Handle | 1" | 02, 04, 05, 09, 14, 24, 68 | 12 ea |
| Quik-Release Handle | | | | |
| 369595 | Quik-Release Vinyl-Coated Metal Handle | — | 00 | 12 ea |
| Quick Change Handles – Wood | | | | |
| 369365 | 60" Wood Mop Handle with Plastic Head | 1.13" | 00 | 12 ea |
| 40340 | 63" Wood Mop Handle with Metal Head | 1.13" | 00 | 12 ea |
| Quick Change Handle – Fiberglass | | | | |
| 369375 | 60" Fiberglass Mop Handle with Plastic Head | 1" | 00 | 12 ea |
| Quick Change Handle – Vinyl Coated Metal | | | | |
| 36968 | 60" Handle with Plastic Head | 1" | 00 | 12 ea |

MOP BUCKETS & SIGNS

Bucket & Wringer Combos

- Made of durable, corrosion resistant polyethylene
- Non-marking casters
- Available in 26 or 35 quart sizes
- Individual Side Press Wringer available – fits both 26 quart (36908) and 35 quart (36904) mop buckets



36904



36908W



36905



36908

Wet Floor Signs

- Durable polypropylene
- Specially designed feet protect floor finishes
- 36900 locks into place to prevent collapsing
- Compact for easy storage



36909



36900

Freestanding Caution Cones

- 360° visibility
- Caution message appears in English, Spanish and French



36941



36942

Case for 36942 Pop Up Caution Cone



Caution Pop Up Cones

- 360° visibility
- Caution message appears in English, Spanish and French
- Case can be mounted to wall for easy access



| Prod No | Description | Color | Pack |
|--------------------------------|---|--------------------|-------|
| Mop Buckets | | | |
| 36908 | 26 qt Bucket with Side Press Wringer | 04, 05, 09, 14, 69 | 1 ea |
| 36904 | 35 qt Bucket with Side Press Wringer | 04, 05, 09, 14, 69 | 1 ea |
| 36908W | Side Press Wringer for 26 qt and 35 qt Mop Bucket | 04, 05, 09, 14, 69 | 1 ea |
| 36905 | 35 qt Bucket with Down Press Wringer | 04 | 1 ea |
| 36908C | 3" Swivel Casters for all Mop Buckets | 00 | 2 ea |
| Folding Wet Floor Signs | | | |
| 36900 | Floor Sign (English/Spanish) | 00 | 6 ea |
| 36909 | Economy Wet Floor Sign (English/Spanish/German) | 04 | 6 ea |
| Caution Cones | | | |
| 36941 | 36" Caution Cone | 04 | 3 ea |
| 36942 | 20" Pop Up Caution Cone | 04 | 12 ea |

FLOOR & RESTROOM MAINTENANCE

Floor Drain Brush

- Long lasting polypropylene bristles and plastic handles stand up to rugged use
- Drain Brush handles (sold separately) are prominently marked in English and Spanish for "floor drain use only" to prevent contact with food and serving utensils
- Available in a variety of sizes



40146

Drain Opener

- Convenient, sanitary way to remove floor drain covers
- Easy to use, simply insert into drain and twist to remove drain cover and drain basket
- One-piece construction with plastic handles for secure grip



40144



| Prod No | Description | Color | Pack |
|--------------------------|--------------------------------|-------|-------|
| Drain Opener | | | |
| 40144 | Drain Opener | 02 | 12 ea |
| Floor Drain Brush | | | |
| 40146 | 3" Floor Drain Brush | 00 | 6 ea |
| 40147 | 4" Floor Drain Brush | 00 | 6 ea |
| 41093 | 5" Floor Drain Brush | 00 | 6 ea |
| 40148 | 6" Floor Drain Brush | 00 | 6 ea |
| 40236 | 36" Plastic Drain Brush Handle | 00 | 12 ea |
| 40237 | 48" Plastic Drain Brush Handle | 00 | 12 ea |

Boot 'N Shoe Brush

- Helps eliminate dirt and other contaminants from being tracked into food prep and serving areas
- Chromed steel tube frame can be bolted to floor for security; brushes flip up to expose a steel scraper
- Non-absorbent plastic block construction with long lasting blue polypropylene bristles



Bowl Brushes

- Bowl brushes are available in a variety of styles and bristle materials
- 40140 has 180° bristle head to prevent splash-back
- 36232 and 36233 have all-natural cotton yarn securely attached to smooth wood handle



Ergonomic Force Cup

- Ergonomic design maximizes applied force while maintaining ease and longevity of use
- Over-molded rubber handle for easy grip
- 21" plastic handle is non-absorbent and more sanitary than wood handles



| Prod No | Description | Handle Material | Color | Pack |
|--------------------------------|---|-----------------|------------|-------|
| Boot 'N Shoe Brush | | | | |
| 40424 | Boot 'N Shoe Brush | — | 01, 03, 14 | 1 ea |
| 40425 | Boot 'N Shoe Brush Replacement | — | 01, 03, 14 | 12 ea |
| Bowl Brushes | | | | |
| 40140 | 17" No-Splash Polyester Brush | Plastic | 00 | 12 ea |
| 36P5 | 17" Twist-In-Wire Synthetic Bristle Brush | Plastic | 02 | 24 ea |
| 3633 | 21" Twist-In-Wire Synthetic Bristle Brush | Plastic | 00 | 24 ea |
| 36232 | 10" Cotton Bowl Mop | Wood | 00 | 36 ea |
| 36233 | 20" Cotton Bowl Mop | Wood | 00 | 36 ea |
| Ergonomic Power Plunger | | | | |
| 36439 | Ergonomic Power Plunger | Plastic/Rubber | 03 | 12 ea |

HANDLE GUIDE

| Prod No | Page | Description | Type of Handle | Recommended Handle |
|--------------------------------|------|-------------------------------|------------------|--------------------|
| Duo-Sweep Brooms | | | | |
| 36859 | 279 | 7" Duo-Sweep Flagged Broom | Threaded | 362019414 |
| 36863 | 279 | 9" Duo-Sweep Flagged Broom | Threaded | 362019414 |
| 36883 | 279 | 11" Duo-Sweep Flagged Broom | Threaded | 362019414 |
| 36860 | 279 | 7" Duo-Sweep Unflagged Broom | Threaded | 362029403 |
| 36864 | 279 | 9" Duo-Sweep Unflagged Broom | Threaded | 362029403 |
| 36884 | 279 | 11" Duo-Sweep Unflagged Broom | Threaded | 362029403 |
| Sweeps | | | | |
| 41880 | 282 | 18" Omni Sweep | Threaded | 40225 |
| 41881 | 282 | 24" Omni Sweep | Threaded | 40225 |
| 36204818 | 283 | 18" Foam Block Fine Sweep | Threaded | 40225 |
| 36204824 | 283 | 24" Foam Block Fine Sweep | Threaded | 40225 |
| 40564 | 283 | 18" Foam Block Medium Sweep | Threaded | 40225 |
| 40565 | 283 | 24" Foam Block Medium Sweep | Threaded | 40225 |
| 40561 | 283 | 18" Foam Block Medium Sweep | Threaded | 40225 |
| 40562 | 283 | 24" Foam Block Medium Sweep | Threaded | 40225 |
| 362208P18 | 283 | 18" Foam Block Medium Sweep | Threaded | 40225 |
| 362208P24 | 283 | 24" Foam Block Medium Sweep | Threaded | 40225 |
| 36207218 | 284 | 18" Foam Block Heavy Sweep | Threaded | 40225 |
| 36207224 | 284 | 24" Foam Block Heavy Sweep | Threaded | 40225 |
| 45222 | 284 | 24" Palmyra Heavy-Duty Sweep | Threaded/Tapered | 40225 |
| 367618 | 284 | 18" Heavy-Duty Sweep | Threaded/Tapered | 40276 |
| 367624 | 284 | 24" Heavy-Duty Sweep | Threaded/Tapered | 40276 |
| Floor & Deck Scrubs | | | | |
| 36175 | 287 | 10" Wood Block Sweep | Tapered | 40261 |
| 36275 | 287 | 12" Wood Block Sweep | Tapered | 40261 |
| 36193 | 287 | 10" Wood Block Scrub | Threaded/Tapered | 40225 |
| 36192 | 287 | 10" Wood Block Sweep | Threaded/Tapered | 40225 |
| 36292 | 287 | 12" Wood Block Scrub | Threaded/Tapered | 40225 |
| 40423 | 287 | 10" Hi-Lo Floor Scrub Brush | Threaded | 40225 |
| 36197 | 287 | 10" Dual Surface Scrub Brush | Threaded | 40225 |
| 36190 | 287 | 10" Dual Action Scrub Brush | Threaded | 40225 |
| 40422 | 287 | 10" Dual Action Scrub Brush | Threaded | 40225 |
| 365300 | 288 | 8" Swivel Scrub | Threaded | 40225 |
| 365310 | 288 | 8" Swivel Scrub | Threaded | 40225 |
| 40430 | 288 | 9" Floor Scrub Brush | Threaded | 40225 |
| 365320 | 288 | Swivel Head Grout Brush | Threaded | 40225 |
| 41323 | 289 | 9" Tile & Grout Brush | Threaded | 40225 |

| Prod No | Page | Description | Type of Handle | Recommended Handle |
|------------------------|------|--------------------------------------|-------------------|--------------------|
| Floor Squeegees | | | | |
| 40081 | 289 | 18" Straight Steel Squeegee | Tapered | 40261 |
| 40082 | 289 | 24" Straight Steel Squeegee | Tapered | 40261 |
| 40083 | 289 | 30" Straight Steel Squeegee | Tapered | 40261 |
| 366318 | 290 | 18" Straight Squeegee | Tapered | 40261 |
| 366324 | 290 | 22" Foam Squeegee | Tapered | 40261 |
| 366330 | 290 | 30" Soft Black Foam Rubber | Tapered | 40261 |
| 41567 | 290 | 18" Plastic Squeegee | Threaded | 40225 |
| 41568 | 290 | 24" Plastic Squeegee | Threaded | 40225 |
| 366824 | 290 | 22" Foam Squeegee Threaded Socket | Threaded | 40267 |
| 366918 | 290 | 18" Red Foam Rubber | Threaded | 40225 |
| 366922 | 290 | 22" Red Foam Rubber | Threaded | 40225 |
| 367818 | 291 | 18" Rubber Squeegee with Bristles | Threaded | 40210 |
| 36324C | 291 | 24" Curved End Black Rubber Squeegee | Tapered | 40261 |
| 36336C | 291 | 36" Curved End Black Rubber Squeegee | Tapered | 40261 |
| 36567 | 291 | 20" Solid, One-Piece Rubber Squeegee | Threaded | 40225 |
| 36568 | 291 | 24" Solid, One-Piece Rubber Squeegee | Threaded | 40225 |
| 40075 | 292 | 18" Straight Steel Squeegee | Tapered | 40261 |
| 40076 | 292 | 24" Straight Steel Squeegee | Tapered | 40261 |
| 40077 | 292 | 36" Straight Steel Squeegee | Tapered | 40261 |
| Misc Floor Care | | | | |
| 40146 | 308 | 3" Floor Drain Brush | Threaded (Female) | 40236 |
| 40147 | 308 | 4" Floor Drain Brush | Threaded (Female) | 40237 |
| 41093 | 308 | 5" Floor Drain Brush | Threaded (Female) | 40237 |
| 40148 | 308 | 6" Floor Drain Brush | Threaded (Female) | 40238 |



CARLISLE
FOODSERVICE PRODUCTS

PROFESSIONAL
DURABLE
TOUGH
HARD-
WORKING
**TRANS-
PORTATION
EQUIPMENT**

Carlisle's high quality dollies, carts and caddies help you reduce the risk of food contamination and employee injuries.





CARTS

Our **unique combination** of space saving design, load capacity and long-lasting durability provide **superior value** and make Fold 'N Go the transport cart every foodservice operation needs.

Perfect for full kitchens, hallways or off-site catering; Fold 'N Go Carts **support 350 pounds** and fold up in a single, quick and easy motion. The cart **ships fully assembled** making ownership a joy from the very beginning.

Fold 'N Go® Carts

- Folds up to store easily behind doors, between counters or in small spaces
- Solid legs and sturdy shelves hold up to 350 pounds
- Cart ships fully assembled; no tools or complicated latches required
- Collapses to 9" width and 10.5" width; stores easily behind doors, in between counters or back of delivery vans
- Folds down, tucks away and is always available for multiple purposes
- Shelves are easy to clean; top shelf has ergonomically shaped, easy grip handles at both ends for a fast, secure grip
- 4" heavy-duty, non-marking swivel casters with molded-in metal reinforcement plates are permanently staked to .75" solid aluminum legs for longer life and added strength and rigidity

Licensed Product under U.S. Patent No. 5806864

SBC1521



SBC2031

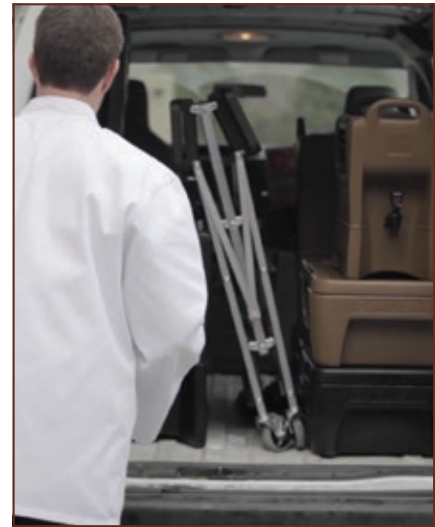

SBC1521



Find replacement parts at
www.carlislefsp.com/replacement-parts



350 lb Capacity



Easily folds with one hand



| Prod No | Description | Weight Capacity | Color | Pack |
|-------------------------|--|-----------------|--------|------|
| Fold 'N Go Carts | | | | |
| SBC1521 | 15" x 21" Fold 'N Go Cart | 350 lb | 03, 23 | 1 ea |
| SBC2031 | 20" x 31" Fold 'N Go Cart | 350 lb | 03, 23 | 1 ea |
| SBCC240 | Fold 'N Go Cart Replacement Caster, Swivel | — | 00 | 1 ea |
| SBCC245 | Fold 'N Go Cart Replacement Caster, Swivel with Brake | — | 00 | 1 ea |
| SBCA30000 | Fold 'N Go Cart Replacement Slide Bracket Assembly | — | — | 1 ea |
| SBCRKIT | Fold 'N Go Hardware Replacement Kit (includes 2 casters) | — | — | 1 ea |



CARTS

Bussing Carts

- Durable construction stands up to the toughest use
- Molded on handles that will not come apart when rolling over bumps and uneven surfaces
- Raised edges on shelves for quick loading and protect from spills and accidents
- Available with optional back panels to hide clutter or locking doors to secure sensitive items like liquor or cleaning supplies (15" x 21" size only)



Find replacement parts at www.carlislefsp.com/replacement-parts



CC2036DP, available with locking doors and side panels to secure sensitive items



| Prod No | Description | Weight Capacity | Color | Pack |
|------------------------|---|-----------------|-------|-------|
| Bussing Carts | | | | |
| CC2243 Δ | 42" x 23" Large Bussing Cart | 300 lb | 03 | 1 ea |
| CC2036 Δ | 18" x 36" Bussing Cart | 300 lb | 03 | 1 ea |
| CC2036DP | 18" x 36" Bussing Cart with Doors and Back Panels | 300 lb | 03 | 1 ea |
| CC2036P | 18" x 36" Bussing Cart with Back Panels | 300 lb | 03 | 1 set |
| CD2036 | 18" x 36" Doors and Back Panels Only | — | 03 | 1 set |
| CP2036 | 18" x 36" Back Panels Only | — | 03 | 1 set |
| CC11SH \blacklozenge | Accessory Bin for Bussing Cart | — | 03 | 1 ea |
| CC11TH | Trash Bin for Bussing Cart | — | 03 | 1 ea |

NSF Listed products are designated with a Δ and may be prefixed with an N

Shipping Notes: CC2036 & SBC1521 can ship UPS/FedEx Ground at oversize cost, CC2243 & SBC2031 cannot ship UPS/FedEx Ground

\blacklozenge California Residents: Bisphenol A **WARNING:** See appendix A on page 281



Stainless Steel Utility Carts

- Utility carts are constructed of heavy gauge stainless steel for superior strength and durability
- Continuous weld construction provides added durability as compared to other, spot welded utility carts
- Non-marking soft rubber bumpers prevent scratches and scuffs on walls



UC4031529



UC3031524



UC7022133

Service Cart

- One-piece design, all plastic construction
- Polyethylene exterior and polyurethane foam core for added strength
- Heavy-duty 5" non-marking caster with molded-in metal reinforcement plates
- Optional Trash Container (SBC11TC) and Part Holder (SBC11SH) available separately
- NSF Listed



Find replacement parts at
[www.carlislefsp.com/
 replacement-parts](http://www.carlislefsp.com/replacement-parts)



SBC230 with SBC11TC
 and SBC11SH

Black(03)

| Prod No | Description | Weight Capacity | Color | Pack |
|--------------------------------------|--|-----------------|-------|------|
| Service Cart | | | | |
| SBC230 Δ | Service Cart - 2 Fixed Casters, 2 Swivel Casters, 1 with Brake | 500 lb | 03 | 1 ea |
| SBC11SH | Part Holder for SBC230 | — | 03 | 1 ea |
| SBC11TC | Trash Container for SBC230 | — | 03 | 1 ea |
| Stainless Steel Utility Carts | | | | |
| UC3031524 | 15.5" x 24", 3 Shelf Utility Cart | 300 lb | — | 1 ea |
| UC3031827 | 18" x 27", 3 Shelf Utility Cart | 300 lb | — | 1 ea |
| UC5031524 | 15.5" x 24", 3 Shelf Utility Cart | 500 lb | — | 1 ea |
| UC5031827 | 18" x 27", 3 Shelf Utility Cart | 500 lb | — | 1 ea |
| UC5032135 | 21" x 35", 3 Shelf Utility Cart | 500 lb | — | 1 ea |
| UC7022133 | 21" x 33", 2 Shelf Utility Cart | 700 lb | — | 1 ea |
| UC7032133 | 21" x 33", 3 Shelf Utility Cart | 700 lb | — | 1 ea |
| UC4031529 | 15.75" x 29.5", 3 Shelf Knock-Down Utility Cart | 400 lb | — | 1 ea |
| UC4031733 | 17.75" x 33.38", 3 Shelf Knock-Down Utility Cart | 400 lb | — | 1 ea |

NSF Listed products are designated with a Δ and may be prefixed with an N

Shipping Notes: SBC230, UC3031524, UC3031827, UC5031524, UC5031827, UC5032135, UC7031524, UC7031827, UC7022133, UC7032133 cannot ship UPS/FedEx



CARTS

Utility Carts

- Excellent for transporting equipment and heavy loads
- Bin top utility carts (UC4018 & UC4525) reduce the potential for items to fall off during transport
- Durable and chemical-resistant polypropylene construction; will not rust, dent, chip or peel
- Convenient knock-down design
- Integrated cord wrap for easy access (UC1940)



UC1940



UC4018



UC1940

Find replacement parts at
www.carlislefsp.com/replacement-parts



| Prod No | Description | Weight Capacity | Color | Pack |
|----------------------|--|-----------------|-------|------|
| Utility Carts | | | | |
| UC1940 | 19" x 40" x 32.5" Utility Cart | 500 lb | 23 | 1 ea |
| UC4018 | 40" x 17.25" Small Bin Top Utility Cart | 500 lb | 23 | 1 ea |
| UC4525 | 45" x 25" Large Bin Top Utility Cart | 500 lb | 23 | 1 ea |
| UCC4018 | Replacement Casters for UC4018 & UC4525 (Swivel, 2 pack) | — | 00 | 1 cs |
| UCC4525 | Replacement Casters for UC4018 & UC4525 (Fixed, 2 pack) | — | 00 | 1 cs |

DISH DOLLIES

Optimizer™ Adjustable Dish Dollies

- Adjustable dividers eliminate the need for individually sized dollies
- Dollies hold plates from 5.5" to 12.5"
- Polyethylene dividers and walls help prevent dish edge chipping
- Two-handed access to all plates reduces breakage
- Non-marking casters (2 locking, 2 non-locking) for easy transport of loaded dollies
- Includes vinyl cover with easy-opening hook & loop side included for sanitary storage
- Find replacement parts at www.carlislefsp.com/replacement-parts
- NSF Listed



ADD4, ADD6 Optimizer Dollies Also Feature:

- Most flexible dolly available; holds trays, plates, and platters
- ADD6 holds oval platters from 9.5" x 7.25" to 13.5" x 10.5"
- Holds 5 stacks of 9.88" to 11.25" plates; 25% more than any other similar dish dolly
- Holds 8 stacks of 5.5" to 8.25" plates; 33-50% more than any other similar dish dolly (up to 50 or more plates per stack, depending on plate profile)
- Use 2 to 4 dividers for 10" or larger plates; 6 dividers for 8" to 9.75" plates; 8 dividers for 8 stacks of 7.75" or smaller plates
- 2 dividers for 13.5" x 10.5" platters; 6 dividers for 9.5" x 7.25" to 12" x 9.25" platters.

ADS4, ADS8 Optimizer Dollies Also Feature:

- Smaller size fits through narrow corridors or under tables
- Flexible configuration holds a variety of plates and platters



ADD4



ADD6

ADD6 Vinyl Cover with ADD6



| Prod No | Description | Color | Pack |
|--|--|---------|------|
| Optimizer Standard Dish Dollies & Accessories | | | |
| ADD4 Δ | Optimizer Dish Dolly with 4 Dividers | 01*, 03 | 1 ea |
| ADD6 Δ | Optimizer Dish Dolly with 6 Dividers | 01*, 03 | 1 ea |
| ADDD Δ | Optimizer Replacement Dividers (Set of 2) | 01, 03 | 2 ea |
| ADDC ♦ | Optimizer Vinyl Replacement Cover (for ADD4 or ADD6) | 07 | 1 ea |
| Optimizer Small Dish Dollies & Accessories | | | |
| ADS4 Δ | Optimizer Small Dish Dolly and 4 Adjustable Dividers | 03 | 1 ea |
| ADS8 Δ | Optimizer Small Dish Dolly and 8 Adjustable Dividers | 03 | 1 ea |
| ADSD | Optimizer Replacement Dividers (Set of 4) | 03 | 1 ea |
| ADSC ♦ | Optimizer Vinyl Replacement Cover (for ADS4 or ADS8) | 07 | 1 ea |

NSF Listed products are designated with a Δ and may be prefixed with an N

Note: ADD4, ADD6, ADS4, ADS8 cannot ship UPS/FedEx

*Color available by special order only

♦ California Residents: Di(2-ethylhexylphthalate (DEHP) **WARNING:** See appendix B on page 1



Optimizer Adjustable Dish Dolly Guide

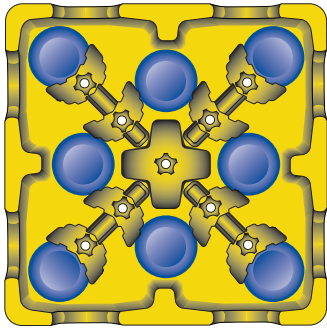

ADS8 Layout for 5.5" round plates

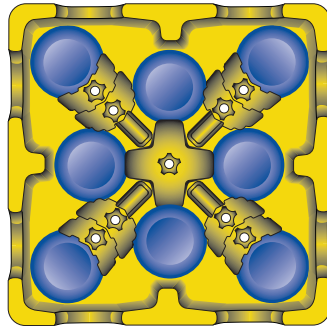

ADS8 Layout for 6.5" round plates

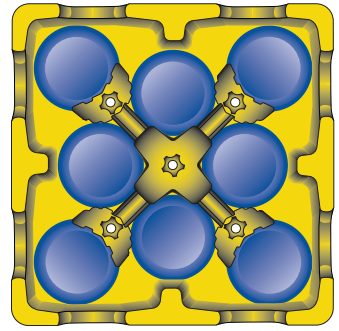

ADS4 Layout for 7.5" round plates and 6" square plates

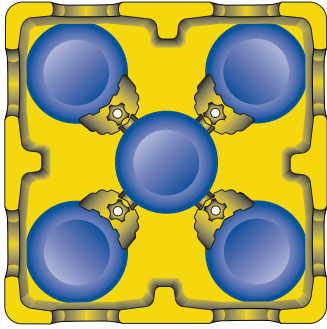

ADS4 Layout for 9" round plates

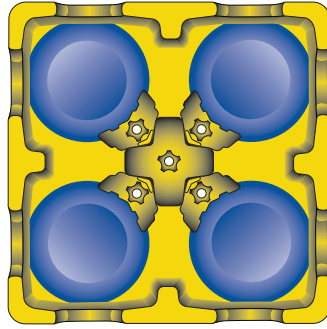

ADS4 Layout for 11" round plates and 8.5" square plates

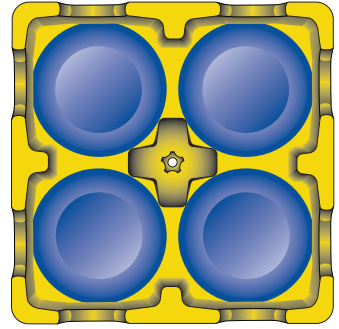

ADS4 Layout for 12" round plates

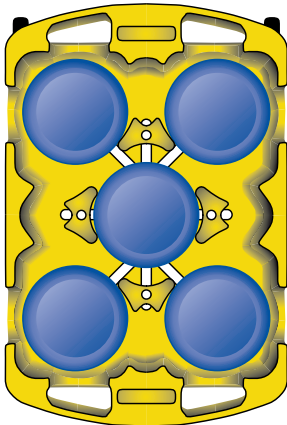

ADD4 Layout for 9.88" to 11.25" round plates

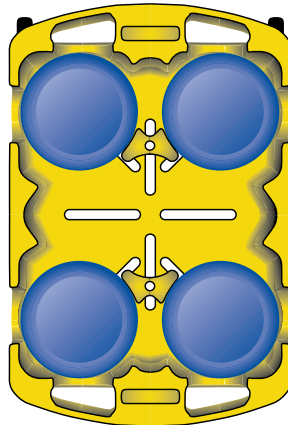

ADD4 Layout for 11.38" to 12.5" round plates, 8.5" to 10.5" square plates and 13.5" by 10.5" platters

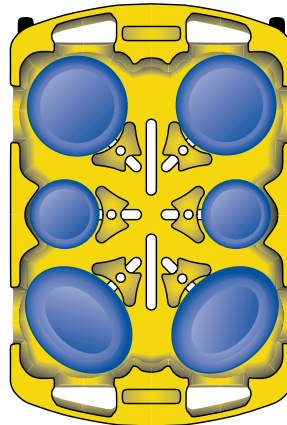

ADD6 Layout for 12" by 9" to 9.5" by 7.25" platters, 5.5" to 8" and 5.5" to 12" round plates

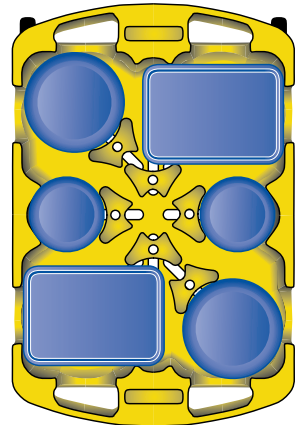

ADD6 Layout for 10" by 14.5" trays and 7.5" and 10" round plates

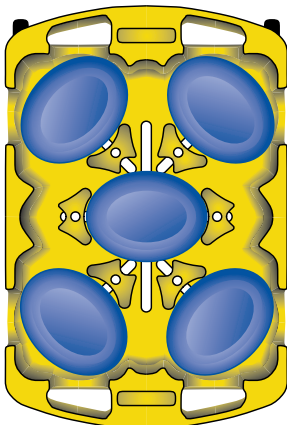

ADD6 Layout for 12" by 9.25" to 9.5" by 7.25" platters

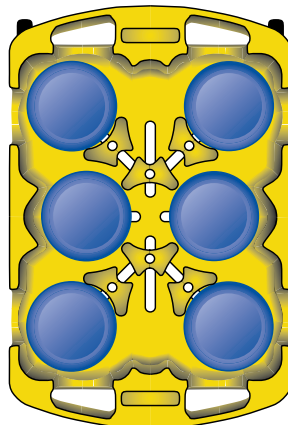

ADD6 Layout for 8.38" to 9.75" round plates

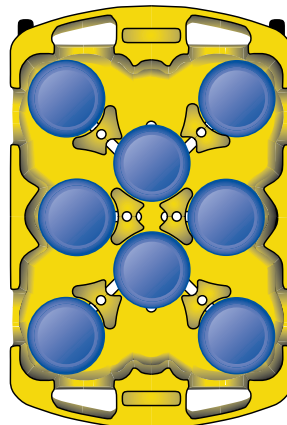

ADD6 Layout for 8" to 9.25" round plates

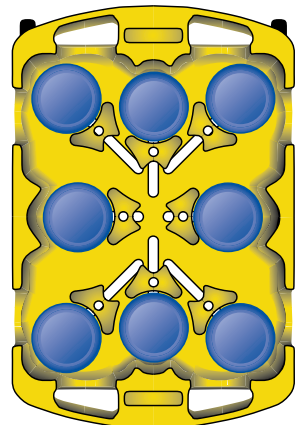

ADD6 Layout with 2 Additional Dividers for 5.5" to 7.88" round plates

JANITORIAL CARTS

Janitorial Carts & Accessories

- Rugged polypropylene resists cracking, peeling and corrosion
- Three durable shelves with raised edges keep items organized
- Platform base holds a Bucket/Wringer or 23 gallon TrimLine™ Waste Container
- Includes a 25 gallon nylon bag for waste or laundry collection
- 3" standard Carlisle non-marking swivel casters in front; large 8" non-marking rear wheels

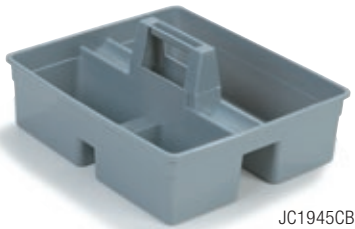

Integrated tool holders, shelves and hooks keep everything organized including unwieldy handles.



Front hooks hold most standard Wet Floor Signs. Built-in hanger holds multiple spray bottles.

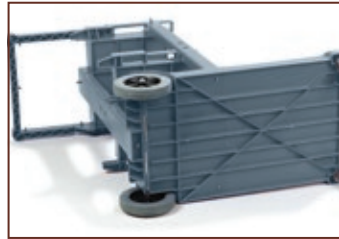

Structurally reinforced base and heavy-duty casters/wheels withstand rough use – holds up to 300 lbs.



Tough 25 gallon nylon bag easily attaches to cart arm. Hooks on top of arm to hold trash liners in place. Arm swings up for more compact storage when not in use.

Tool Caddy

- Handled caddy fits in the top compartment of the JC1945 cart series
- Deep compartments prevent spills
- Made of durable polypropylene

| Prod No | Description | Weight Capacity | Color | Pack |
|---|---|-----------------|-------|------|
| Janitorial Carts & Accessories | | | | |
| JC1945S | 45"L x 19"W x 39"H Short Platform Janitorial Cart | 300 lb | 23 | 1 ea |
| JC1945L | 49"L x 19"W x 39"H Long Platform Janitorial Cart | 300 lb | 23 | 1 ea |
| JC1946 | Replacement Bag for JC1945S & JC1945L | — | 14 | 1 ea |
| JC1945CB | Tool Caddy for Janitorial Cart | — | 23 | 1 ea |
| 36908C | 3" Replacement Casters | — | 00 | 2 ea |



CARLISLE
FOODSERVICE PRODUCTS



RUGGED
QUALITY
DURABLE
**WASTE
MANAGEMENT
PRODUCTS**

Carlisle offers a solution for all of your waste and material handling needs. Our products are built to last and feature the rugged construction and durability you expect.



WASTE CONTAINERS & LIDS

When it comes to **waste and material handling**, you can count on Carlisle to deliver products designed for **heavy duty usage**.

Bronco™

- Heavy-duty construction with double-reinforced stress ribs; drag skids for durability
- Comfort Curve™ handles provide easy handling
- Helper handles on base for controlled tipping or overhead lifting
- Reinforced lids have snap down tab locks with a simple press & pull release system for easy removal
- NSF Std 21 – meets the criteria for thermoplastic refuse containers
- NSF Std 2 – meets the criteria for food contact and cleanability

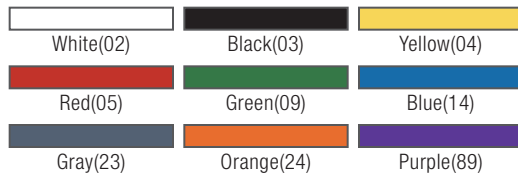

Built-In Durability

| Prod No | Description | Color | Pack |
|---|--|-------------------------------------|------|
| Bronco Round Waste Containers & Lids | | | |
| 341010 Δ | 10 gal Waste Container, 16.13" x 17" | 02, 03, 04, 05, 09, 14, 23, 24, 89* | 6 ea |
| 341011 Δ | 10 gal Lid, 16.13" x 2" | 02, 03, 04, 05, 09, 14, 23, 24, 89 | 6 ea |
| 341020 Δ | 20 gal Waste Container, 20" x 23" | 02, 03, 04, 05, 09, 14, 23, 24, 89* | 6 ea |
| 341021 Δ | 20 gal Lid, 20" x 2.13" | 02, 03, 04, 05, 09, 14, 23, 24, 89* | 6 ea |
| 341032 Δ | 32 gal Waste Container, 22.38" x 27.75" | 02, 03, 04, 05, 09, 14, 23, 24, 89 | 4 ea |
| 341033 Δ | 32 gal Lid, 24" x 2.13" | 02, 03, 04, 05, 09, 14, 23, 24, 89 | 4 ea |
| 341034 | 32 gal Dome Lid | 03 | 1 ea |
| 341035 | 32 gal Funnel Lid | 03 | 4 ea |
| 341044 Δ | 44 gal Waste Container, 26.88" x 31.38" | 02, 03, 04, 05, 09, 14, 23, 24, 89 | 3 ea |
| 341045 Δ | 44 gal Lid 26.88" x 2.25" | 02, 03, 04, 05, 09, 14, 23, 24, 89 | 3 ea |
| 341055 Δ | 55 gal Waste Container, 26.5" x 33" | 02, 03, 04, 05, 09, 14, 23, 89* | 2 ea |
| 341056 Δ | 55 gal Lid, 26.5" x 2.25" | 02, 03, 04, 05, 09, 14, 23, 89* | 2 ea |
| 341057 | 44/55 gal Dome Lid | 03 | 1 ea |
| 341132 Δ | 32 gal Container with Dolly, 22.38" x 38.25" | 02, 04, 05, 09, 14, 23 | 4 ea |
| 341144 Δ | 44 gal Container with Dolly, 26.88" x 37.75" | 02, 04, 05, 09, 14, 23 | 3 ea |

NSF Listed products are designated with a Δ and may be prefixed with an N

*Color available by special order only

9 Colors

Our round Bronco containers come in 9 colors and are made with NSF 2 certified materials which meet the criteria for food contact and cleanability. Excellent for storing and segregating large amounts of food products.



Hot Stamped Bronco™ Containers

- Carlisle offers several standard Hot Stamped containers for waste management, visit carlislefsp.com/custom-imprinting
- Standard stamps:
 - INEDIBLE
 - USDA CONDEMNED
 - TRASH
 - ICE ONLY
 - ICE MELT
- Custom hot stamping is also available; contact Customer Service at 1-800-654-8210 for custom imprinting information



Tool Caddy Bag

- Economical, adjustable caddy bag can hold an assortment of cleaning tools
- Turns a 32 or 44 gallon Bronco into a portable and durable cleaning system platform



| Prod No | Description | Color | Pack |
|-------------------------------------|--|-------|-------|
| Hot Stamped Bronco Container | | | |
| 341010ICE Δ | 10 gal "Ice Only" Container | 02 | 6 ea |
| Tool Caddy Bag | | | |
| 36917 | Tool Caddy Bag for 32 & 44 gal Bronco Waste Containers | 04 | 12 ea |

NSF Listed products are designated with a Δ and may be prefixed with an N

WASTE CONTAINERS & LIDS

Carlisle Dollies

- Dollies fit our 20, 32, 44 and 55 gallon containers for safe transport of heavy loads
- Simple twist-to-lock feature securely attaches dolly to containers
- Dollies include standard Carlisle non-marking 3" swivel casters
- NSF Std 2—meets the criteria for food contact and cleanability

36910



50 Gallon Roll-Away Container

- Super heavy-duty axle and oversize traction wheels make hauling heavy loads easy
- Unique handle design gives positive grip even when wet
- Sturdy hinged lid flips open 270° and snaps shut tight
- NSF Std 21 – meets the criteria for thermoplastic refuse containers
- NSF Std 2 – meets the criteria for food contact and cleanability

345050



Recycling options shown on pages 330-331



| Prod No | Description | Color | Pack |
|----------------------------|--|--------|------|
| Carlisle Dollies | | | |
| 36911 Δ | Standard Round Container Dolly, 17.75" x 6" | 03 | 2 ea |
| 36910 Δ | Round Container Dolly with Replaceable Casters | 03 | 2 ea |
| 3672231 | 3" Replacement Caster for 36910 Dolly | — | 1 ea |
| Roll-Away Container | | | |
| 345050 Δ | 50 gal Rolling Container, 21" x 21" x 38.25" | 14, 23 | 2 ea |

NSF Listed products are designated with a Δ and may be prefixed with an N

TrimLine™

- Designed for narrow spaces
- Self-venting for easier bag removal
- Corner tabs keep bag in place
- Helper handle on bottom makes lifting and dumping easier



TrimLine™ Dolly

- Efficient transport reduces transportation time
- Low profile design allows dolly and container to fit under standard foodservice counters
- For use with 15 or 23 gallon size TrimLine container or similar competitor slim-style trash cans
- 200 lb weight capacity



| Prod No | Description | Color | Pack |
|----------------------------|---|------------------------|------|
| TrimLine Containers | | | |
| 342015 | 15 gal TrimLine Container | 23 | 4 ea |
| 342023 | 23 gal TrimLine Container | 03, 06, 09, 14, 23, 69 | 4 ea |
| 342024 | TrimLine Swing Top Lid, 20.13" x 11.5" x 4.5" | 03, 06, 23, 69 | 4 ea |
| 342025 | TrimLine Handled Lid, 20.5" x 11.5" x 3" | 03 | 4 ea |
| 369210 | TrimLine Dolly | 03 | 1 ea |

WASTE CONTAINERS & LIDS

Centurian™

- Attractive yet durable
- Self-venting design for easier bag removal
- Corner tabs keep bag in place



 Recycling options shown on pages 330-331



| Prod No | Description | Color | Pack |
|-----------------------------------|--|----------------|------|
| Centurian Waste Containers | | | |
| 343021 | 21 gal Half Round Centurian Container | 06, 23 | 4 ea |
| 343022 | Half Round Centurian Lid for 343021 | 03, 06, 23 | 4 ea |
| 343122 | 22 gal Tall Round Centurian Container | 23 | 4 ea |
| 343123 | Swing Top Centurian Lid for 343122 | 23 | 4 ea |
| 343124 | Funnel Top Centurian Lid for 343122 | 23 | 4 ea |
| 343523 | 23 gal Tall Square Centurian Container | 06, 23, 69 | 4 ea |
| 343525 | Swing Top Centurian Lid for 343523 | 03, 06, 23, 69 | 4 ea |
| 343935 | 35 gal Centurian Square Waste Receptacle | 06, 23 | 4 ea |
| 343951 | Large Centurian Lid for 343935, 343950 | 06, 23 | 4 ea |

Office Wastebaskets

- Economical polypropylene
- Smooth inner surface makes cleaning easy
- Light yet durable design

 Recycling options shown on pages 330-331



Fire Resistant Wastebaskets

- Ideal for use in areas or applications requiring an extra degree of fire protection including schools, health care and hospitality
- Textured finish minimizes appearance of scuffs and scratches
- UL Listed; will contain burning paper without contributing fuel to the fire



| Prod No | Description | Color | Pack |
|------------------------------------|----------------------------------|------------|-------|
| Office Wastebaskets | | | |
| 342913 | 13 qt Office Wastebasket | 03, 06, 23 | 12 ea |
| 342928 | 28 qt Office Wastebasket | 03, 06, 23 | 12 ea |
| 342941 | 41 qt Office Wastebasket | 03, 06, 23 | 12 ea |
| Fire Resistant Wastebaskets | | | |
| 342915 | 14 qt Fire Resistant Wastebasket | 03 | 6 ea |
| 342927 | 28 qt Fire Resistant Wastebasket | 03 | 6 ea |
| 342940 | 41 qt Fire Resistant Wastebasket | 03 | 4 ea |

RECYCLE CONTAINERS & ACCESSORIES

Recycle options are great for offices, hospitality, industrial, restaurants and more.

Bronco™



341032REC



341032REC

341033REC

Centurian™



343527REC

343523REC



343937REC

343935REC



343022

343021REC



| Prod No | Description | Color | Pack |
|--|---|--------|------|
| Bronco Recycle Waste Containers & Lids | | | |
| 341020REC Δ | 20 gal Recycle Waste Container | 09, 14 | 6 ea |
| 341021REC Δ | 20 gal Recycle Lid with 8" Hole | 09, 14 | 6 ea |
| 341032REC Δ | 32 gal Recycle Waste Container | 09, 14 | 4 ea |
| 341033REC Δ | 32 gal Recycle Lid with 8" Hole | 09, 14 | 4 ea |
| 341044REC Δ | 44 gal Recycle Waste Container | 09, 14 | 3 ea |
| 341045REC Δ | 44 gal Recycle Lid with 8" Hole | 14 | 3 ea |
| Centurian Recycle Waste Containers & Lids | | | |
| 343021REC | 21 gal Half Round Centurian Recycle Container | 14 | 4 ea |
| 343022 | Half Round Centurian Lid for 343021REC | 03 | 4 ea |
| 343523REC | 23 gal Tall Square Centurian Recycle Container | 14 | 4 ea |
| 343526REC | Paper Recycle Centurian Lid for 343523REC | 14 | 4 ea |
| 343527REC | Bottle/Can Recycle Centurian Lid for 343523REC | 14 | 4 ea |
| 343935REC | 35 gal Recycle Centurian Square Waste Receptacle | 14 | 4 ea |
| 343936REC | Bottle/Can Recycle Centurian Lid for 343935REC, 343950REC | 14 | 4 ea |
| 343937REC | Paper Recycle Centurian Lid for 343935REC, 343950REC | 14 | 4 ea |
| 34RECLBL | Recycle Label Kit | — | 1 ea |

NSF Listed products are designated with a Δ and may be prefixed with an N

TrimLine™



Roll-Away



Office Wastebaskets



Recycle Label Kit



34RECLBL

Includes one set of eleven color-coded symbol labels and three sets of eleven word labels in English, Spanish and French



| Prod No | Description | Color | Pack |
|---|--|--------|-------|
| TrimLine Recycle & Compost Containers & Lids | | | |
| 342015REC | 15 gal TrimLine Recycle Container | 14 | 4 ea |
| 342023REC | 23 gal TrimLine Recycle Container | 09, 14 | 4 ea |
| 342023CMP | 23 gal TrimLine Compost Container | 09 | 4 ea |
| 342026REC | Paper Recycle Lid for 343023REC & 342015REC | 14 | 4 ea |
| 342027REC | Bottle/Can Recycle Lid for 343023REC & 342015REC | 14 | 4 ea |
| 342025 | TrimLine Handled Lid | 03 | 4 ea |
| Carlisle Roll-Away Recycle Container | | | |
| 345050REC Δ | 50 gal Recycle Rolling Container | 14 | 2 ea |
| Office Recycle Wastebaskets | | | |
| 342913REC | 13 qt Office Recycle Wastebasket | 14 | 12 ea |
| 342928REC | 28 qt Office Recycle Wastebasket | 14 | 12 ea |
| 342941REC | 41 qt Office Recycle Wastebasket | 14 | 12 ea |
| Recycle Label Kit | | | |
| 34RECLBL | Recycle Label Kit | — | 1 ea |

NSF Listed products are designated with a Δ and may be prefixed with an N

TILT TRUCKS

Perfect for **transporting bulky loads** and/or consolidating smaller loads for more **efficient transport**

- Lightweight, durable, rotationally molded design improves maneuverability
- Smooth inner and outer surface makes cleaning easy
- Non-marking, swivel casters allow for easy transportation
- 5/8 Yard easily fits through standard doorways
- Made with more than 70% post consumer recycled material
- Meets EPA recommended recovered materials content levels for office recycling containers and waste receptacles and is perfect for specifying on school and government agency bids
- Lids available for each size
- Powder coated steel wheel frame



TTS150

5/8 Yard Capacity

Light Duty – 450lb
Standard Duty – 850lb
Wheel Diameter: 10"
Dimensions: 26"W x 38"H x 54"L
 (fits through standard doorway)



1 Yard Capacity

Standard Duty – 850lb
Heavy Duty – 1,200lb
Wheel Diameter: 10"
Dimensions: 32.5"W x 42.75"H x 68"L



1.5 Yard Capacity

Heavy Duty – 1,200lb
Wheel Diameter: 12"
Dimensions: 40.5"W x 48.5"H x 79.5"L



**Lids Available
 For Each Size**



Black(03)

| Prod No | Description | Weight Capacity | Color | Pack |
|--------------------|-------------------------|-----------------|-------|------|
| Tilt Trucks | | | | |
| TTL580 | 5/8 Yard Light Duty | 450lb | 03 | 1 ea |
| TTS580 | 5/8 Yard Standard Duty | 850lb | 03 | 1 ea |
| TTL580 | 5/8 Yard Tilt Truck Lid | — | 03 | 1 ea |
| TTS100 | 1 Yard Standard Duty | 850lb | 03 | 1 ea |
| TTH100 | 1 Yard Heavy Duty | 1200lb | 03 | 1 ea |
| TTL100 | 1 Yard Tilt Truck Lid | — | 03 | 1 ea |
| TTS150 | 1.5 Yard Standard Duty | 1200lb | 03 | 1 ea |
| TTL150 | 1.5 Yard Tilt Truck Lid | — | 03 | 1 ea |



REPLACEMENT PARTS

In order to better identify and find the replacement parts you are looking for, we have created an easy-to-use web page. Please use the web address below and the steps outlined to navigate and find what you are looking for.

www.carlislefsp.com/replacement-parts

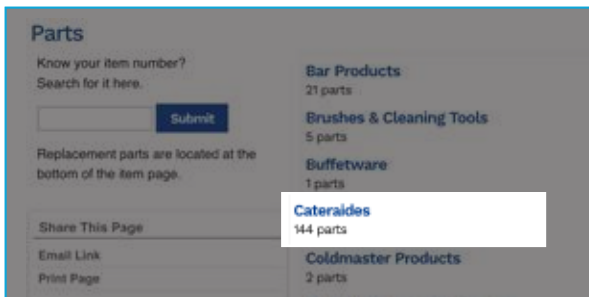
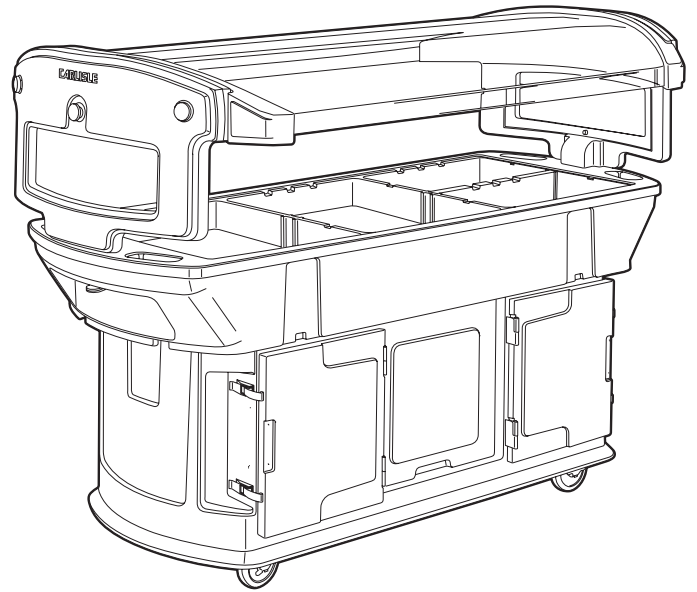

2. Replacement Parts Landing Page

You will navigate to a list of product groups with the total amount of parts available listed below the title

Click on the category you need or search by item #

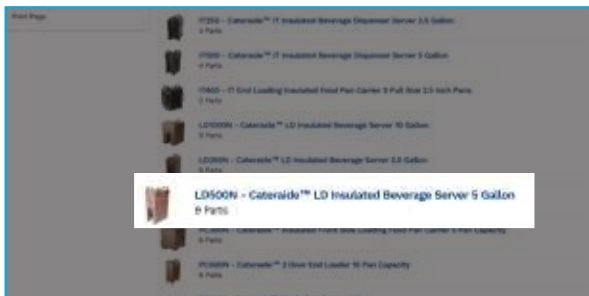

3. Category Listing

After choosing your category, you will find a list of products within that category

Click on the item that needs a new part

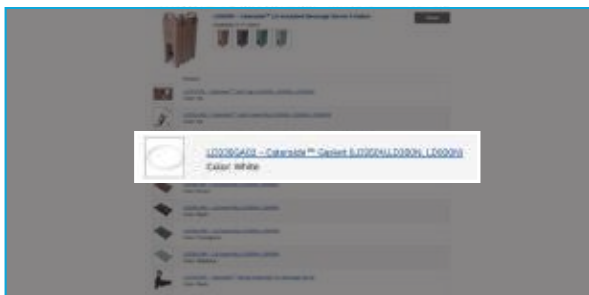

4. Available Replacement Parts Drop Down Menu

A drop down menu will reveal the available replacement parts for your product

Click on the specific replacement part that you need



5. Replacement Part Item Page

Lastly, you will be taken to an item level web page that will list additional information for the part

CUSTOM DECORATING

For more information and a complete list of custom decorating options please visit the url below.

www.carlislefsp.com/customer-service/custom-decorating

Carlisle offers a variety of options to customize the products that we produce. From screen printing to hot stamping, we can add your logo to items ranging from plates to trash cans.

For more information please visit our custom decorating webpage listed above or contact Carlisle Customer Service by phone at 1-800-654-8210 or via email at customerservice@carlislefsp.com



PRODUCT INDEX

| Prod No | Page No | Prod No | Page No | Prod No | Page No | Prod No | Page No |
|---------|--------------|----------|---------|---------|---------|-----------|---------|
| 0120 | 42 | 10203B | 220 | 10435 | 222 | 10720-307 | 229 |
| 0132 | 42 | 10210U | 220 | 10436U | 222 | 10721 | 228 |
| 0200 | 232 | 10211U | 220 | 10437U | 222 | 10721-307 | 229 |
| 0202 | 118-119, 232 | 10212B | 222 | 10438Z | 222 | 10722 | 228 |
| 0203 | 232 | 10212B | 220 | 10439Z | 222 | 10722-207 | 229 |
| 0205 | 232 | 10215 | 220 | 10440B | 222 | 10723 | 228 |
| 0240 | 121 | 10216U | 220 | 10440Z | 222 | 10723-207 | 229 |
| 0261 | 121 | 10217U | 220 | 10441B | 222 | 10724 | 228 |
| 0287 | 121 | 10220B | 220 | 10450U | 222 | 10725 | 228 |
| 0295 | 121 | 10221B | 220 | 10463KF | 223 | 10726 | 228 |
| 0296 | 121 | 10222B | 220 | 10470U | 222 | 10730 | 228 |
| 0300 | 118 | 10223B | 220 | 10471U | 222 | 10730-302 | 229 |
| 0301 | 118 | 10230U | 220 | 10476U | 222 | 10731 | 228 |
| 0302 | 118 | 10231U | 220 | 10477U | 222 | 10731-302 | 229 |
| 0304 | 118 | 10232B | 222 | 10478Z | 222 | 10732 | 228 |
| 0311 | 118 | 10232B | 220 | 10479Z | 222 | 10732-202 | 229 |
| 0316 | 118 | 10235 | 220 | 10480Z | 222 | 10733 | 228 |
| 0333 | 63 | 10236U | 220 | 10490U | 222 | 10733-202 | 229 |
| 0340 | 96 | 10238Z | 220 | 10491U | 222 | 10734 | 228 |
| 0341 | 118 | 10239Z | 220 | 10496U | 222 | 10735 | 228 |
| 0342 | 118 | 10240B | 220 | 10510U | 222 | 10736 | 228 |
| 0343 | 118 | 10240Z | 220 | 10511U | 222 | 10740 | 228 |
| 0344 | 96 | 10241B | 220 | 10516U | 222 | 10741 | 228 |
| 0345 | 29 | 10250U | 220 | 10518Z | 222 | 10742 | 228 |
| 0347 | 29 | 10256U | 220 | 10519Z | 222 | 10761 | 231 |
| 0350 | 232 | 10270U | 221 | 10535 | 222 | 10763 | 231 |
| 0355 | 232 | 10271U | 221 | 10536U | 222 | 10764 | 231 |
| 0362 | 59 | 10276U | 221 | 10537U | 222 | 10765 | 231 |
| 0365 | 119 | 10277U | 221 | 10538Z | 222 | 10766 | 231 |
| 0372 | 119 | 10278Z | 221 | 10539Z | 222 | 10767 | 231 |
| 0386 | 253 | 10279Z | 221 | 10601 | 143 | 10768 | 231 |
| 0411 | 90 | 10280Z | 221 | 10602 | 143 | 10769 | 231 |
| 0470 | 64 | 10290U | 221 | 10610 | 226 | 10770 | 231 |
| 0475 | 64 | 10291U | 221 | 10611 | 226 | 10771 | 231 |
| 0600 | 232 | 10296U | 221 | 10611C | 226 | 10772 | 231 |
| 0602 | 118, 232 | 10297U | 221 | 10612 | 226 | 10773 | 231 |
| 0603 | 232 | 1030 | 161 | 10612C | 226 | 10806 | 128 |
| 0605 | 232 | 10302FMT | 156 | 10617 | 226 | 10807 | 128 |
| 0700 | 65 | 1030FMT | 156 | 10617C | 226 | 10820 | 133 |
| 0703 | 65 | 1031 | 161 | 10620 | 226 | 10828 | 131 |
| 0707 | 65 | 10310U | 221 | 10621 | 226 | 10850 | 132 |
| 0710 | 65 | 10311U | 221 | 10621C | 226 | 10851 | 132 |
| 0713 | 65 | 10316U | 221 | 10622 | 226 | 10852 | 132 |
| 0717 | 65 | 10317U | 221 | 10622C | 226 | 10853 | 132 |
| 0800 | 232 | 10318Z | 221 | 10623 | 226 | 10854 | 132 |
| 0805 | 232 | 10319Z | 221 | 10623C | 226 | 10856 | 132 |
| 0820 | 59 | 10335 | 221 | 10624 | 226 | 10857 | 132 |
| 0830 | 59 | 10336U | 221 | 10624C | 226 | 1100GL | 163 |
| 0831 | 59 | 10337U | 221 | 10627 | 226 | 1100GR2 | 162 |
| 0843 | 59 | 10338Z | 221 | 10627C | 226 | 11020 | 104 |
| 0844 | 59 | 10339Z | 221 | 10628 | 226 | 11026 | 104 |
| 0845 | 59 | 10400B | 222 | 10629 | 226 | 11030 | 104 |
| 0852 | 58 | 10401B | 222 | 10630 | 227 | 11036 | 104 |
| 0855 | 57 | 10402B | 222 | 10631 | 227 | 1104 | 42 |
| 0860 | 56 | 10410U | 222 | 10632 | 227 | 1105 | 42 |
| 0862 | 56 | 10411U | 222 | 10637 | 227 | 1108 | 42 |
| 0864 | 57 | 10415 | 222 | 10640 | 227 | 1110 | 42 |
| 0873 | 58 | 10416U | 222 | 10641 | 227 | 1110L | 53 |
| 0875 | 58 | 10417U | 222 | 10642 | 227 | 1112 | 42 |
| 0878 | 58 | 10420B | 222 | 10643 | 227 | 1116 | 42 |
| 1000B | 87 | 10421B | 222 | 10644 | 227 | 1200 | 232 |
| 10145 | 160 | 10422B | 222 | 10647 | 227 | 1202 | 232 |
| 10200B | 220 | 10423B | 222 | 10648 | 227 | 1205 | 232 |
| 10201B | 220 | 10430U | 222 | 1071 | 253 | 1212FG | 151-153 |
| 10202B | 220 | 10431U | 222 | 10720 | 228 | 1212WFG | 151 |

PRODUCT INDEX

| Prod No | Page No | Prod No | Page No | Prod No | Page No | Prod No | Page No |
|----------|--------------|----------|----------|----------|---------|------------|----------|
| 1216LDFG | 151, 155 | 2015DFG | 151, 155 | 30695 | 221 | 34101OICE | 199, 325 |
| 1216LFG | 151-154 | 2015FG | 151-155 | 30860 | 222 | 341011 | 199, 324 |
| 1216LWFG | 151, 155 | 2015GR2 | 162 | 30860H | 223 | 341020 | 324 |
| 1217BT | 157 | 2015WFG | 151, 155 | 30860HH | 223 | 341020REC | 330 |
| 1218FMT | 156 | 2115DFG | 151 | 30861 | 222 | 341021 | 324 |
| 1219LDFG | 151 | 2115FG | 151-152 | 30861H | 223 | 341021REC | 330 |
| 1219LFG | 151-152, 154 | 2115WFG | 151 | 30861HH | 223 | 341032 | 324 |
| 1219LWFG | 151 | 2200 | 232 | 30862 | 222 | 341032REC | 330 |
| 1220DFG | 151 | 2205 | 232 | 30869 | 222 | 341033 | 324 |
| 1220FG | 151-155 | 2209 | 133 | 30870 | 222 | 341033REC | 330 |
| 1220WFG | 151 | 2210 | 133 | 30871 | 223 | 341034 | 324 |
| 1220WFG | 155 | 2214DFG | 151 | 30880 | 222 | 341035 | 324 |
| 1222LDFG | 151 | 2214FG | 151-155 | 30881 | 222 | 341044 | 324 |
| 1222LFG | 151-152, 154 | 2214WFG | 151 | 30882 | 222 | 341044REC | 330 |
| 1222LWFG | 151 | 2216FG | 151 | 30883 | 222 | 341045 | 324 |
| 1230FMT | 156 | 2216FGQ | 151-155 | 30884 | 222 | 341045REC | 330 |
| 1252 | 232 | 2216GR2Q | 162 | 30885 | 222 | 341055 | 324 |
| 1300 | 66 | 2216WFGQ | 151 | 30886 | 222 | 341056 | 324 |
| 1318DFG | 151 | 2219 | 133 | 30887 | 222 | 341057 | 324 |
| 1318FG | 151-153, 155 | 2227 | 133 | 30888 | 222 | 341132 | 324 |
| 1318FMT | 156 | 2229 | 133 | 30895 | 222 | 341144 | 324 |
| 1319BT | 157 | 2230 | 133 | 30896 | 222 | 342015 | 327 |
| 1400GL | 163 | 2310DFG | 151 | 3100GR2 | 162 | 342015REC | 331 |
| 1400GR2 | 162 | 2310FG | 151 | 3210 | 143 | 342023 | 327 |
| 1401 | 161 | 2310WFG | 151 | 3211 | 143 | 342023CMP | 331 |
| 1410DFG | 151, 155 | 2419 | 163 | 3253GR2 | 162 | 342023REC | 331 |
| 1410FG | 151-155 | 2500 | 59 | 33000 | 16 | 342024 | 327 |
| 1410WFG | 151, 155 | 2500GR2 | 162 | 33002 | 16 | 342025 | 327, 331 |
| 1418LDFG | 151 | 2512 | 99 | 33004 | 16 | 342026REC | 331 |
| 1418LFG | 151-154 | 2618DFGQ | 151 | 33006 | 16 | 342027REC | 331 |
| 1419DFG | 151 | 2618FGQ | 151-155 | 33008 | 16 | 342913 | 329 |
| 1419FG | 151, 154 | 2618FMTQ | 156 | 33010 | 16 | 342913REC | 331 |
| 1419WFG | 151 | 2618WFGQ | 151 | 33012 | 16 | 342915 | 329 |
| 1520LDFG | 151 | 269DFG | 151 | 33016 | 16 | 342927 | 329 |
| 1520LFG | 151-155 | 269FG | 151-155 | 33018 | 16 | 342928 | 329 |
| 1520LWFG | 151, 155 | 269FMT | 156 | 33020 | 16 | 342928REC | 331 |
| 1532 | 230 | 269WFG | 151, 155 | 33024 | 16 | 342940 | 329 |
| 1544 | 230 | 2700GR2 | 162 | 33030 | 17 | 342941 | 329 |
| 1556 | 230 | 2710 | 233 | 33032 | 17 | 342941REC | 331 |
| 1568 | 230 | 2823 | 163 | 33034 | 17 | 343021 | 328 |
| 1600GL | 163 | 3004 | 99 | 33036 | 17 | 343021REC | 330 |
| 1600GR2 | 162 | 3014 | 163 | 33038 | 17 | 343022 | 328, 330 |
| 1612DFG | 151 | 3016 | 163 | 33040 | 17 | 343122 | 328 |
| 1612FG | 151-155 | 3020 | 161 | 33042 | 17 | 343123 | 328 |
| 1612WFG | 151 | 3022 | 161 | 33080 | 17 | 343124 | 328 |
| 1629 | 230 | 3042 | 138-139 | 33082 | 17 | 343523 | 328 |
| 1713DFG | 151, 155 | 30580 | 221-222 | 33086 | 17 | 343523REC | 330 |
| 1713FG | 151-155 | 30581 | 221-222 | 3316 | 60 | 343525 | 328 |
| 1713WFG | 151, 155 | 30582 | 221-222 | 3319 | 60 | 343526REC | 330 |
| 1800 | 232 | 30583 | 221-222 | 33302 | 82 | 343527REC | 330 |
| 1805 | 232 | 30660 | 221 | 33310 | 82 | 343935 | 328 |
| 1814DFG | 151, 155 | 30661 | 221 | 33312 | 82 | 343935REC | 330 |
| 1814FG | 151-155 | 30662 | 221 | 33314 | 82 | 343936REC | 330 |
| 1814GR2 | 162 | 30669 | 221 | 33316 | 82 | 343937REC | 330 |
| 1814WFG | 151, 155 | 30670 | 221 | 33318 | 82 | 343951 | 328 |
| 1826GR2Q | 162 | 30680 | 221 | 33320 | 82 | 345050 | 326 |
| 1900 | 32 | 30681 | 221 | 33322 | 82 | 345050REC | 331 |
| 1960 | 32 | 30682 | 221 | 33324 | 82 | 356 | 62 |
| 1965 | 32 | 30683 | 221 | 33326 | 82 | 36P5 | 309 |
| 1987 | 32 | 30684 | 221 | 33360 | 81 | 361410 | 286 |
| 1989 | 32 | 30685 | 221 | 33362 | 81 | 36141003-1 | 286 |
| 1991 | 32 | 30686 | 221 | 33364 | 81 | 361412 | 285 |
| 1992 | 32 | 30687 | 221 | 339 | 96 | 361415 | 285 |
| 1993 | 32 | 30688 | 221 | 34RECLBL | 330-331 | 361416 | 285 |
| 1994 | 32 | 30689 | 221 | 341010 | 324 | 361420 | 286 |

PRODUCT INDEX

| Prod No | Page No | Prod No | Page No | Prod No | Page No | Prod No | Page No |
|-----------|--------------|----------|----------|----------|---------|-----------|----------|
| 361437 | 286 | 365320 | 289, 310 | 36942 | 307 | 38704CSIB | 141 |
| 36175 | 287, 310 | 365351 | 289 | 369420 | 302 | 38705C | 141 |
| 36190 | 287, 310 | 365380 | 288 | 369424B | 301 | 38706C | 141 |
| 36192 | 287, 310 | 365408 | 294 | 369425B | 301 | 38800GLC | 131 |
| 36193 | 287, 310 | 365450 | 274 | 369430 | 301 | 38820C | 130 |
| 36197 | 287, 310 | 365501 | 267 | 369442B | 301 | 38830C | 130 |
| 362013 | 295 | 36552 | 263 | 369448B | 301 | 38850GEW | 130 |
| 3620194 | 278-279, 294 | 36567 | 291, 311 | 369454B | 301 | 388804L | 131 |
| 3620294 | 278-279, 294 | 36568 | 291, 331 | 369460 | 301 | 38882G | 130 |
| 36204818 | 283, 310 | 36592 | 292 | 369472B | 301 | 38883G | 130 |
| 36204824 | 283, 310 | 36596 | 292 | 369475 | 305 | 38884G | 130 |
| 36207218 | 284, 310 | 366318 | 290, 311 | 369478B | 301 | 3956 | 207 |
| 36207224 | 310 | 366324 | 290, 311 | 369484B | 301 | 3957 | 207 |
| 36211 | 273 | 36633 | 280 | 369551B | 301 | 3958 | 207 |
| 362113 | 295 | 366330 | 290, 311 | 369552B | 301 | 3959 | 207 |
| 36219618 | 282 | 36634 | 281 | 369595 | 306 | 3960 | 207 |
| 36219624 | 282 | 366824 | 290, 311 | 369670B | 302 | 3961 | 207 |
| 36219663 | 288 | 366918 | 290, 311 | 369674B | 302 | 3970 | 207 |
| 362208P18 | 283, 310 | 366922 | 290, 311 | 36968 | 306 | 3971 | 207 |
| 362208P24 | 283, 310 | 3672231 | 326 | 36970 | 305 | 3980 | 207 |
| 36232 | 309 | 36752 | 267 | 369724 | 303 | 3981 | 207 |
| 36233 | 309 | 367600TC | 267 | 369732 | 303 | 3990 | 207 |
| 36236 | 286 | 367618 | 284, 310 | 369811B | 303 | 3991 | 207 |
| 36239 | 270 | 367624 | 284, 310 | 369814B | 303 | 3992 | 207 |
| 36275 | 287, 310 | 367818 | 291, 311 | 369816B | 303 | 3993 | 207 |
| 36289 | 265 | 3682 | 280 | 369817B | 303 | 4000 | 260 |
| 36292 | 287, 310 | 36853 | 279 | 369819B | 303 | 40001 | 260 |
| 363156 | 274 | 36854 | 279 | 369820B | 303 | 40002 | 260 |
| 36324C | 291, 311 | 36859 | 279, 310 | 369824B | 303 | 40003 | 260 |
| 3633 | 309 | 36860 | 279, 310 | 369832 | 303 | 40004 | 260 |
| 3633019 | 298 | 36861 | 278 | 36990 | 305 | 40005 | 260 |
| 3633118 | 297 | 36863 | 279, 310 | 36990R | 305 | 40006 | 260 |
| 3633124 | 297 | 36864 | 279, 310 | 381109LG | 128 | 40007 | 260 |
| 3633136 | 297 | 36865 | 278 | 381206LG | 128 | 40008 | 260 |
| 3633218 | 297 | 36867 | 278 | 3812CH | 198 | 40010 | 260 |
| 3633224 | 297 | 36868 | 278 | 3812CM | 198 | 40020 | 270 |
| 36333 | 274 | 36873 | 279 | 3812MP | 198 | 40021 | 270 |
| 36334 | 274 | 36874 | 279 | 3816 | 213 | 40022 | 270 |
| 3633519 | 297 | 36883 | 279, 310 | 3816CH | 198 | 40023 | 270 |
| 3633525 | 297 | 36884 | 279, 310 | 3816MP | 198 | 40024 | 265 |
| 3633537 | 297 | 36885 | 278 | 3816WH | 198 | 40025 | 263 |
| 36336C | 291, 311 | 36900 | 307 | 3817 | 213 | 40026 | 268 |
| 3633670 | 297 | 369024C | 304 | 38180A | 198 | 40027 | 269 |
| 363404 | 274 | 369024R | 304 | 3820CH | 198 | 40028 | 264 |
| 363725 | 268 | 36904 | 307 | 3820MP | 198 | 40040 | 264 |
| 36396 | 267 | 36905 | 307 | 38240A | 198 | 40042 | 264 |
| 36399 | 286 | 369066B | 304 | 38310 | 128 | 4006 | 120 |
| 36400 | 286 | 369070B | 304 | 38322BH | 140 | 40070 | 275 |
| 36439 | 309 | 369074B | 304 | 38332BH | 140 | 40071 | 275 |
| 3647248 | 298 | 36908 | 307 | 38342BH | 140 | 40074 | 275 |
| 3647524 | 298 | 36908C | 307, 321 | 38360 | 198 | 40075 | 292, 311 |
| 3647536 | 298 | 36908W | 307 | 38360A | 198 | 40076 | 292, 311 |
| 3647548 | 298 | 369082 | 304 | 38480 | 198 | 40077 | 292, 311 |
| 36490 | 298 | 36909 | 307 | 38480A | 198 | 4008 | 42 |
| 36490R | 298 | 36910 | 326 | 38502 | 129 | 40081 | 289, 311 |
| 365015 | 272 | 36911 | 326 | 38503 | 129 | 40082 | 289, 311 |
| 36505 | 272 | 36917 | 325 | 38504 | 129 | 40083 | 289, 311 |
| 36505L | 272 | 369210 | 327 | 38600R | 116 | 4009 | 120 |
| 36509L | 272 | 369320 | 302 | 38601 | 129 | 4010 | 42 |
| 365117 | 275 | 369365 | 306 | 386010 | 129 | 40107 | 289 |
| 365120 | 275 | 369375 | 306 | 386230IB | 129 | 40108 | 289 |
| 36513 | 272 | 36941 | 307 | 38623IB | 129 | 40109 | 289 |
| 36513L | 272 | 369412B | 301 | 38655 | 28, 115 | 40110 | 262 |
| 365300 | 288, 310 | 369418B | 301 | 38704C | 141 | 40111 | 262 |
| 365310 | 288, 310 | 369419B | 301 | 38704CNS | 141 | 40112 | 262 |

PRODUCT INDEX

| Prod No | Page No | Prod No | Page No | Prod No | Page No | Prod No | Page No |
|---------|----------|---------|----------|---------|--------------|---------|---------------|
| 40113 | 262 | 40361 | 210 | 40673 | 263 | 43002 | 15 |
| 40114 | 262 | 40361C | 211 | 40674 | 266 | 43004 | 15 |
| 40115 | 262 | 40362 | 210 | 40675 | 266 | 43006 | 15 |
| 4012 | 42 | 40370 | 200 | 40676 | 266 | 43008 | 15 |
| 40120 | 262 | 40371 | 200 | 40681 | 212 | 43010 | 15 |
| 40121 | 262 | 40372 | 200 | 40682 | 212 | 43012 | 15 |
| 40122 | 262 | 40373 | 200 | 40710 | 269 | 43016 | 15 |
| 40123 | 262 | 40374 | 200 | 40711 | 269 | 43018 | 15 |
| 40140 | 309 | 40375 | 200 | 40712 | 269 | 43024 | 15, 84 |
| 40144 | 308 | 40376 | 200 | 40713 | 269 | 43030 | 15 |
| 40146 | 308, 311 | 40377 | 200 | 40724 | 288 | 43032 | 15 |
| 40147 | 308, 311 | 40378 | 201 | 40725 | 288 | 43034 | 15 |
| 40148 | 308, 311 | 40379 | 201 | 40728 | 266 | 43036 | 15 |
| 40150 | 264 | 40380 | 200 | 40729 | 266 | 43038 | 15 |
| 40152 | 264 | 40390 | 202 | 40731 | 296 | 43040 | 15 |
| 40153 | 263 | 40391 | 202 | 40732 | 296 | 43042 | 15 |
| 40154 | 263 | 40392 | 202 | 40733 | 296 | 43050 | 15 |
| 40155 | 263 | 40393 | 202 | 40735 | 296 | 4306 | 145, 147, 199 |
| 40156 | 263 | 40394 | 202 | 40737 | 296 | 43066 | 48 |
| 40157 | 263 | 40395 | 201 | 410 | 56 | 43068 | 48 |
| 4016 | 42 | 40396 | 201 | 41020 | 293-294 | 43080 | 15 |
| 40164 | 203 | 40397 | 201 | 41027 | 275 | 43082 | 15 |
| 40180 | 263 | 40398 | 201 | 41076 | 213 | 43086 | 15 |
| 4020 | 42 | 40399 | 201 | 41076-1 | 213 | 43121 | 59 |
| 40210 | 293 | 40400 | 201 | 41077 | 213 | 43122 | 59 |
| 40220 | 293 | 40401 | 201 | 41077-1 | 213 | 43123 | 59 |
| 40224 | 294 | 40402 | 201 | 41082 | 278 | 43125 | 58 |
| 40225 | 293 | 40403 | 202 | 41083 | 278 | 43126 | 59 |
| 40227 | 293 | 40405 | 202 | 4109 | 120 | 43141 | 204 |
| 40230 | 294 | 40412 | 203 | 41093 | 308, 311 | 43142 | 204 |
| 40232 | 294 | 40413 | 267 | 41169 | 262 | 43143 | 204 |
| 40233 | 294 | 40415 | 261 | 41199C | 293 | 43144 | 204 |
| 40236 | 308 | 40422 | 287, 310 | 412 | 56 | 43145 | 204 |
| 40237 | 308 | 40423 | 287, 310 | 41225 | 278-279, 293 | 4315 | 204 |
| 40261 | 295 | 40424 | 309 | 41226 | 293 | 4322 | 206 |
| 40262 | 295 | 40425 | 309 | 41270 | 266 | 4324 | 206 |
| 40267 | 295 | 40430 | 288, 310 | 41291 | 293 | 4326 | 206 |
| 40271 | 295 | 40460 | 261 | 41323 | 289, 310 | 4328 | 206 |
| 40275 | 295 | 40461 | 261 | 41349 | 280 | 4329 | 206 |
| 4029 | 42 | 40462 | 261 | 41350 | 280 | 4330 | 206 |
| 40290 | 268 | 40465 | 261 | 41352 | 280 | 43304 | 26 |
| 40291 | 268, 275 | 40466 | 261 | 41354 | 280 | 43306 | 26 |
| 40293 | 268, 275 | 40467 | 261 | 414 | 56 | 43308 | 26 |
| 40294 | 268 | 40468 | 261 | 41506 | 261 | 4332 | 199 |
| 40300 | 305 | 40480 | 273 | 41520 | 268 | 43410 | 25 |
| 40301 | 305 | 40481 | 273 | 41567 | 290, 311 | 43420 | 25 |
| 40305 | 305 | 40485 | 273 | 41568 | 290, 311 | 43422 | 25 |
| 40306 | 305 | 40500 | 271 | 41664 | 306 | 43500 | 19 |
| 4033 | 45 | 40501 | 271 | 41672 | 298 | 43501 | 19 |
| 4034 | 45 | 40521 | 260 | 41673 | 298 | 43503 | 19 |
| 40340 | 306 | 40529 | 265 | 41679 | 281 | 43504 | 19 |
| 40345 | 304 | 40532 | 265 | 41680 | 281 | 43505 | 19 |
| 40347 | 210 | 40541 | 271 | 41683 | 281 | 43512 | 19 |
| 40349 | 210 | 40542 | 271 | 41880 | 282, 310 | 43514 | 19 |
| 4035 | 45 | 40545 | 271 | 41881 | 282, 310 | 43516 | 19 |
| 40350 | 210 | 40546 | 271 | 4206 | 120 | 43520 | 19 |
| 40350C | 211 | 40561 | 283, 310 | 4230 | 208 | 43521 | 19 |
| 40351 | 210 | 40562 | 283, 310 | 4231 | 208 | 43522 | 19 |
| 40352 | 210 | 40564 | 283, 310 | 4250 | 208 | 43525 | 19 |
| 40352C | 211 | 40565 | 283, 310 | 4251 | 208 | 43528 | 19 |
| 40353 | 210 | 40634 | 280 | 4260 | 208 | 43529 | 19 |
| 40354 | 210 | 40650 | 278 | 4261 | 208 | 43531 | 19 |
| 40355 | 210 | 40670 | 269 | 4270 | 208 | 43532 | 19 |
| 40356 | 210 | 40671 | 269 | 4271 | 208 | 43533 | 19 |
| 40359 | 210 | 40672 | 269 | 43000 | 15 | 43540 | 19 |

PRODUCT INDEX

| Prod No | Page No | Prod No | Page No | Prod No | Page No | Prod No | Page No |
|---------|---------|-----------|---------|---------|----------|-------------|---------|
| 4355 | 121 | 43854 | 23 | 44522 | 83 | 4968 | 207 |
| 43560 | 19 | 43856 | 23 | 44524 | 83 | 500B | 30 |
| 43563 | 19 | 43858 | 23 | 4460 | 121 | 500M | 30 |
| 4358 | 206 | 43860 | 23 | 4470 | 121 | 509 | 121 |
| 4360 | 206 | 43862 | 23 | 4471 | 121 | 5105-2 | 45 |
| 4360-5 | 206 | 43864 | 23 | 4512 | 31, 48 | 5108-2 | 45 |
| 4361 | 206 | 43866 | 23 | 45222 | 284, 310 | 5109-2 | 45 |
| 4362 | 206 | 43868 | 23 | 45259 | 294 | 5109L | 53 |
| 43620 | 44 | 43872 | 23 | 45267 | 295 | 5116-2 | 45 |
| 43621 | 44 | 4390 | 206 | 4530 | 28 | 5120 | 45 |
| 43622 | 44 | 4390-5 | 206 | 4531 | 28 | 5212 | 39 |
| 43623 | 44 | 4391 | 206 | 4532 | 28 | 5212-2 | 39 |
| 43624 | 44 | 43937 | 39 | 4533 | 28 | 5212L | 53 |
| 43625 | 44 | 43942 | 57 | 4534 | 28 | 5216 | 39 |
| 43626 | 44 | 43943 | 57 | 4535 | 28 | 5216C203 | 40 |
| 43627 | 44 | 43944 | 57 | 45411 | 273 | 5216IB203 | 40 |
| 43628 | 44 | 43965 | 48 | 45463 | 264, 272 | 5216RB203 | 40 |
| 43629 | 44 | 43980 | 159 | 4549 | 60 | 5216-2 | 39 |
| 43630 | 44 | 43981 | 159 | 45493 | 264, 272 | 52163550D | 40 |
| 43631 | 44 | 43982 | 159 | 4550 | 60 | 52163550E | 40 |
| 43633 | 46 | 43983 | 159 | 4551 | 60 | 52163841A | 40 |
| 43635 | 46 | 43984 | 160 | 4553 | 58 | 52163841F | 40 |
| 43636 | 46 | 43986 | 160 | 45571 | 269 | 5216841C2 | 40 |
| 43637 | 46 | 43988 | 159 | 4560 | 60 | 5220 | 39 |
| 43638 | 46 | 43989 | 159 | 4563 | 60 | 5220C203 | 40 |
| 4364 | 199 | 439945200 | 43 | 45643 | 281 | 5220IB203 | 40 |
| 43640 | 46 | 44010 | 253 | 45649 | 281 | 5220RB203 | 40 |
| 43647 | 41 | 44010SKD | 253 | 45733 | 274 | 5220-2 | 39 |
| 43648 | 41 | 44011 | 253 | 4575 | 61 | 52203550 | 40 |
| 43649 | 41 | 44011SKD | 253 | 45772 | 268 | 52203550A | 40 |
| 43651 | 41 | 44012 | 253 | 45779 | 269 | 52203841B | 40 |
| 43653 | 41 | 44030 | 62 | 45781 | 266 | 52203841G | 40 |
| 43655 | 41 | 44031 | 62 | 45850 | 295 | 5220841C2 | 40 |
| 43662 | 46 | 4410 | 121 | 4606 | 120 | 5224 | 39 |
| 43663 | 46 | 4411 | 121 | 4609 | 120 | 5224C203 | 40 |
| 43664 | 46 | 4415 | 213 | 4650 | 61 | 5224IB203 | 40 |
| 43665 | 46 | 4416 | 213 | 4651 | 61 | 5224RB203 | 40 |
| 43666 | 46 | 4420 | 121 | 4709 | 120 | 52243550G | 40 |
| 43668 | 46 | 4421 | 121 | 4712 | 120 | 52243550H | 40 |
| 43674 | 46 | 4425 | 213 | 4806 | 120 | 52243841C | 40 |
| 4370 | 206 | 4426 | 213 | 4900 | 213 | 52243841H | 40 |
| 4370-5 | 206 | 4430 | 121 | 49110-1 | 203 | 5224841C2 | 40 |
| 4371 | 206 | 4431 | 121 | 49112-1 | 203 | 5232 | 39 |
| 43737 | 86 | 44400 | 84 | 49116-1 | 203 | 5232C203 | 40 |
| 43738 | 86 | 44402 | 84 | 49122-1 | 203 | 5232IB243 | 40 |
| 43739 | 86 | 44404 | 84 | 4921 | 207 | 5232RB203 | 40 |
| 43743 | 209 | 44406 | 84 | 4922 | 207 | 5232-63550J | 40 |
| 43744 | 209 | 44410 | 84 | 4923 | 207 | 5232-63550I | 40 |
| 43745 | 86 | 44410C | 85 | 4924 | 207 | 52323841I | 40 |
| 43772 | 86 | 44412 | 84 | 4925 | 207 | 5232841C2 | 40 |
| 4380 | 206 | 44414 | 84 | 4926 | 207 | 52412L | 53 |
| 4380-5 | 206 | 44414C | 85 | 4927 | 207 | 53000 | 8 |
| 43800 | 27 | 44416 | 84 | 4928 | 207 | 53001 | 8 |
| 43801 | 27 | 44418 | 84 | 4929 | 207 | 53002 | 8 |
| 43803 | 27 | 44420 | 85 | 4930 | 207 | 53003 | 8 |
| 43806 | 27 | 44422 | 85 | 4931 | 207 | 53004 | 8 |
| 4381 | 206 | 44430 | 85 | 4932 | 207 | 53005 | 8 |
| 4381-5 | 206 | 44432 | 85 | 4933 | 207 | 53006 | 8 |
| 43813 | 27 | 44432C | 85 | 4961 | 207 | 53007 | 8 |
| 43814 | 27 | 44460 | 85 | 4962 | 207 | 53008 | 8 |
| 43822 | 27 | 44462 | 85 | 4963 | 207 | 53009 | 8 |
| 43840 | 86 | 4450 | 121 | 4964 | 207 | 53010 | 8 |
| 43842 | 86 | 44514 | 83 | 4965 | 207 | 53011 | 8 |
| 43850 | 23 | 44518 | 83 | 4966 | 207 | 53101 | 9 |
| 43852 | 23 | 44520 | 83 | 4967 | 207 | 53102 | 9 |

PRODUCT INDEX

| Prod No | Page No | Prod No | Page No | Prod No | Page No | Prod No | Page No |
|---------|---------|---------|---------|----------|----------|----------|---------|
| 53103 | 9 | 5616 | 36 | 60204 | 100 | 60700HL6 | 225 |
| 53104 | 9 | 5640 | 37 | 60205 | 100 | 60700HLC | 225 |
| 53105 | 9 | 5641 | 37 | 60206 | 100 | 60708RS | 183 |
| 53106 | 9 | 5642 | 37 | 60207 | 100 | 6071A | 225 |
| 53107 | 9 | 5643 | 37 | 60208 | 100 | 60710RS | 183 |
| 53108 | 9 | 5644 | 37 | 60209 | 100 | 60712RS | 183 |
| 53109 | 9 | 5645 | 37 | 60210 | 100 | 607120C | 225 |
| 53110 | 9 | 5646 | 37 | 60211 | 100 | 607120CS | 225 |
| 54001 | 11 | 5648 | 37 | 602202 | 225 | 607122 | 225 |
| 54002 | 11 | 5649 | 37 | 602203 | 225 | 607122P | 225 |
| 54003 | 11 | 5650 | 37 | 602400 | 59 | 607124P | 225 |
| 54004 | 11 | 5651 | 37 | 602424 | 190 | 607124 | 225 |
| 54005 | 11 | 5652 | 37 | 602500 | 59 | 607126 | 225 |
| 54007 | 11 | 575B | 30 | 60275 | 209 | 607130C | 225 |
| 54018 | 11 | 575M | 30 | 60277 | 209 | 607130CS | 225 |
| 54019 | 11 | 5806 | 41 | 60278 | 209 | 607132 | 225 |
| 5501 | 39 | 5808 | 41 | 60279 | 209 | 607134 | 225 |
| 5501-2 | 39 | 5810 | 41 | 60280 | 209 | 607136 | 225 |
| 5505 | 43 | 5810L | 53 | 60300-10 | 205 | 607140C | 225 |
| 5506 | 39 | 5812 | 41 | 60300-12 | 205 | 607140CS | 225 |
| 5506L | 53 | 5812L | 53 | 60300-16 | 205 | 607142 | 225 |
| 5506-2 | 39 | 5814 | 41 | 60300-20 | 205 | 607144 | 225 |
| 5508 | 43 | 5816 | 41 | 60300-24 | 205 | 607146 | 225 |
| 5509 | 43 | 5818 | 41 | 60300-30 | 205 | 607160C | 225 |
| 5512 | 43 | 5820 | 41 | 60300-40 | 205 | 607160CS | 225 |
| 5517 | 43 | 5822 | 41 | 60300-6 | 205 | 607162 | 225 |
| 5519 | 43 | 5822L | 53 | 60300-8 | 205 | 607164 | 225 |
| 5526 | 39 | 5832 | 41 | 60306 | 188 | 607166 | 225 |
| 5526-2 | 39 | 5865 | 159 | 6031 | 208 | 607190C | 225 |
| 5529 | 39 | 5933 | 27, 86 | 60344 | 189 | 607190CS | 225 |
| 5529-2 | 39 | 600295 | 101 | 60345 | 189 | 607192 | 225 |
| 5532 | 39 | 600296 | 101 | 60346 | 189 | 607194 | 225 |
| 5532-2 | 39 | 60100PC | 185 | 604144 | 190 | 607230C | 225 |
| 5536 | 49 | 601000 | 187 | 604174 | 190 | 607232 | 225 |
| 5538 | 49 | 601001 | 187 | 604360 | 205 | 607236 | 225 |
| 5540 | 49 | 601002 | 187 | 604361 | 205 | 607550 | 212 |
| 5544 | 49 | 601003 | 187 | 604370 | 205 | 607552 | 212 |
| 5546 | 49 | 60101 | 185 | 604371 | 205 | 607556 | 212 |
| 5547 | 49 | 60102 | 185 | 604380 | 205 | 607560 | 212 |
| 55520 | 80 | 601028 | 187 | 604381 | 205 | 607562 | 212 |
| 55522 | 80 | 601029 | 187 | 604390 | 205 | 607566 | 212 |
| 55524 | 80 | 60103 | 187 | 604392 | 205 | 607680 | 102 |
| 55526 | 80 | 601031 | 187 | 604460 | 101 | 607682 | 102 |
| 55528 | 80 | 601306 | 191 | 604606 | 101 | 607683 | 102 |
| 55530 | 80 | 601526 | 208 | 604609 | 101 | 607685 | 102 |
| 55532 | 80 | 601527 | 208 | 606040 | 199 | 607687 | 102 |
| 55534 | 80 | 601528 | 208 | 606055 | 199 | 607690 | 102 |
| 55536 | 80 | 601529 | 208 | 606086 | 199 | 607691 | 102 |
| 55538 | 80 | 601642 | 191 | 606106 | 145, 147 | 607692 | 102 |
| 55540 | 80 | 601647 | 191 | 606902 | 190 | 607693 | 102 |
| 55542 | 80 | 601824 | 191 | 606903 | 190 | 607695 | 102 |
| 55544 | 80 | 601825 | 191 | 6070A | 225 | 607697 | 102 |
| 55546 | 80 | 601826 | 191 | 607000C | 225 | 608002 | 225 |
| 55550 | 80 | 601828 | 191 | 607000CS | 225 | 608004 | 225 |
| 5570 | 50 | 601829 | 190 | 607000H | 225 | 608006 | 225 |
| 5573 | 50 | 601830 | 190 | 607001 | 225 | 608122 | 225 |
| 5583 | 50 | 601834 | 190 | 607002 | 225 | 608124 | 225 |
| 5587 | 50 | 601837 | 190 | 607002D | 225 | 608126 | 225 |
| 5601 | 36 | 601840 | 190 | 607002P | 225 | 608132 | 225 |
| 5602 | 36 | 601922 | 188 | 607004 | 225 | 608134 | 225 |
| 5603 | 36 | 601923 | 188 | 607004P | 225 | 608136 | 225 |
| 5609 | 36 | 60200 | 100 | 607006 | 225 | 608142 | 225 |
| 5610 | 36 | 60201 | 100 | 607006P | 225 | 608144 | 225 |
| 5612 | 36 | 60202 | 100 | 60700HL2 | 225 | 608146 | 225 |
| 5614 | 36 | 60203 | 100 | 60700HL4 | 225 | 608162 | 225 |

PRODUCT INDEX

| Prod No | Page No | Prod No | Page No | Prod No | Page No | Prod No | Page No |
|-----------|---------|---------|---------|---------|---------|---------|---------|
| 608164 | 225 | 609316 | 104 | 6527 | 63 | 7208 | 97 |
| 608166 | 225 | 60934 | 185 | 6528 | 63 | 7210 | 97 |
| 608192 | 225 | 61115 | 184 | 6529 | 63 | 7212 | 97 |
| 608194 | 225 | 61120 | 184 | 6531 | 91 | 7215 | 97 |
| 608236 | 225 | 61120C | 186 | 6532 | 91 | 7218 | 97 |
| 60830 | 209 | 61125 | 184 | 6534 | 91 | 7223 | 97 |
| 608600 | 146 | 61125C | 186 | 6550 | 62 | 7400 | 31 |
| 608901 | 164 | 61130 | 184 | 6551 | 62 | 7405 | 31 |
| 608902 | 164 | 61130C | 186 | 6552 | 62 | 7420 | 31 |
| 608904 | 164 | 61210 | 184 | 6553 | 62 | 7550 | 137 |
| 608905 | 164 | 61210C | 186 | 6600 | 125 | 7555 | 137 |
| 608907 | 164 | 61212 | 184 | 6601 | 125 | 7670 | 126 |
| 608908 | 164 | 61216 | 184 | 6605 | 125 | 7671 | 126 |
| 608909 | 164 | 61216C | 186 | 6606 | 125 | 7711 | 123 |
| 608913 | 164 | 61220 | 184 | 6608 | 125 | 7721 | 123 |
| 608918 | 164 | 61220C | 186 | 6611 | 125 | 7725 | 123 |
| 608919 | 164 | 61224 | 184 | 6620 | 125 | 7910 | 89 |
| 608924 | 30 | 61224C | 186 | 6621 | 125 | 7913 | 89 |
| 609001 | 101 | 61232 | 184 | 6625 | 125 | 7914 | 89 |
| 609002 | 101 | 61232C | 186 | 6713 | 92 | 7916 | 89 |
| 609005 | 101 | 61240 | 184 | 6716 | 92 | 7918 | 89 |
| 609006 | 101 | 61240C | 186 | 6723 | 92 | 7919 | 89 |
| 609007 | 101 | 61260 | 184 | 6726 | 92 | 7920 | 89 |
| 609009 | 101 | 61260C | 186 | 6843 | 99 | 7930 | 87 |
| 60907C | 186 | 614 | 159 | 6863 | 99 | 7932 | 87 |
| 60907RS | 183 | 614PC | 159 | 6904 | 29 | 7934 | 87 |
| 60907SERS | 182 | 614R | 159 | 6907 | 29 | 7940 | 26 |
| 60907XRS | 182 | 615 | 159 | 6908 | 95 | 7942 | 26 |
| 60908C | 186 | 61702 | 185 | 6909 | 95 | 7944 | 83 |
| 60908RS | 183 | 61702C | 186 | 6914 | 95 | 7946 | 83 |
| 60908SERS | 182 | 61704 | 185 | 6917 | 95 | 7948 | 83 |
| 60908XRS | 182 | 61704C | 186 | 6919 | 95 | 800B | 30 |
| 60910C | 186 | 61707 | 185 | 6931 | 95 | 800M | 30 |
| 60910RS | 183 | 61707C | 186 | 6942 | 95 | 8004 | 48 |
| 60910SERS | 182 | 61708 | 185 | 6947 | 95 | 8038 | 96 |
| 60910XRS | 182 | 61708C | 186 | 6954 | 29 | 8099 | 96 |
| 609106 | 147 | 61710 | 185 | 6956 | 29 | 8100 | 96 |
| 609107 | 146 | 61710C | 186 | 6963 | 90 | 8104 | 48 |
| 60912C | 186 | 6302FMT | 156 | 6966 | 90 | 8110 | 94 |
| 60912RS | 183 | 630FMT | 156 | 6982 | 93 | 8112 | 94 |
| 60912SERS | 182 | 63910L | 53 | 6982L | 93 | 830FMT | 156 |
| 60912XRS | 182 | 63912L | 53 | 6984 | 93 | 8302FMT | 156 |
| 609131 | 66 | 6400 | 203 | 6984L | 93 | 8821 | 94 |
| 609132 | 66 | 64001 | 12 | 69844 | 93 | 8886 | 92 |
| 609133 | 66 | 64002 | 12 | 69846 | 93 | 8887 | 92 |
| 60914C | 186 | 64003 | 12 | 6986 | 93 | 8888 | 92 |
| 60914RS | 183 | 64005 | 12 | 69864 | 93 | 8919 | 89 |
| 60914SERS | 182 | 64007 | 12 | 69866 | 93 | 8920 | 89 |
| 60914XRS | 182 | 6401 | 203 | 6988 | 93 | 9051 | 126 |
| 609143 | 146 | 64013 | 12 | 6990 | 93 | 9052 | 126 |
| 609146 | 146 | 64018 | 12 | 7000 | 47 | 91020 | 32 |
| 609190 | 147 | 64020 | 12 | 7006 | 31 | 91040 | 32 |
| 609191 | 147 | 64022 | 12 | 7008 | 31 | 91055 | 32 |
| 609193 | 147 | 64023 | 12 | 7038 | 119 | 91065 | 32 |
| 609201 | 98 | 6413 | 165 | 7039 | 119 | 91070 | 32 |
| 609202 | 98 | 6416 | 165 | 70900 | 47 | 91075 | 32 |
| 609203 | 98 | 6417 | 165 | 70901 | 47 | 91080 | 32 |
| 609204 | 98 | 6426 | 165 | 70902 | 47 | 91085 | 32 |
| 609209 | 98 | 6439 | 165 | 70903 | 47 | 91090 | 32 |
| 60921 | 185 | 6450 | 165 | 70904 | 47 | 91095 | 32 |
| 609211 | 98 | 650B | 30 | 70905 | 47 | 9148 | 126 |
| 609216 | 98 | 650M | 30 | 7110 | 67 | 9160 | 126 |
| 609270 | 51 | 6504 | 63 | 7111-4 | 67 | 9172 | 126 |
| 609273 | 51 | 6524 | 63 | 7112 | 67 | 9224 | 126 |
| 609310 | 104 | 6526 | 63 | 7206 | 97 | 9248 | 126 |

PRODUCT INDEX

| Prod No | Page No | Prod No | Page No | Prod No | Page No | Prod No | Page No |
|----------|---------|-----------|---------|-----------|---------|----------|---------|
| 9260 | 126 | CM1042 | 113 | GA55013 | 13 | IC2250T | 179 |
| 9272 | 126 | CM1042LP | 113 | GA55014 | 13 | IC2254 | 179 |
| 9710 | 126 | CM1043 | 113 | GR09 | 144 | IG224 | 147 |
| 9712 | 126 | CM1045 | 113 | GR10 | 144 | IT1000 | 170 |
| 9720 | 126 | CM1046 | 113 | Group A | 33 | IT140 | 171 |
| 9722 | 126 | CM1049 | 113 | Group AT | 33 | IT160 | 171 |
| ADD4 | 319 | CM1058 | 117 | Group B | 33 | IT180 | 171 |
| ADD6 | 319 | CM1065 | 117 | Group BT | 33 | IT250 | 170 |
| ADDC | 319 | CM1069 | 117 | Group C | 33 | IT400 | 171 |
| ADDD | 319 | CM1100 | 111 | Group CT | 33 | IT410 | 171 |
| ADS4 | 319 | CM1100C14 | 108 | Group D | 33 | IT500 | 170 |
| ADS8 | 319 | CM1101 | 111 | Group DT | 33 | JC1945CB | 321 |
| ADSC | 319 | CM1101C14 | 108 | Group E | 33 | JC1945L | 321 |
| ADSD | 319 | CM1102 | 111 | Group ET | 33 | JC1945S | 321 |
| ARR112 | 86 | CM1102C14 | 108 | Group P1 | 33 | JC1946 | 321 |
| ARR120 | 86 | CM1103 | 111 | Group P1T | 33 | KL102 | 21 |
| ARR240 | 86 | CM1103C14 | 108 | Group P2 | 33 | KL108 | 21 |
| BC05 | 142 | CM1104 | 111 | Group P2T | 33 | KL115 | 21 |
| BIN27 | 233 | CM1104C14 | 108 | Group P3 | 33 | KL116 | 21 |
| BIN27L | 233 | CM1105 | 111 | Group P3T | 33 | KL118 | 21 |
| BIN36 | 233 | CM1105C14 | 108 | Group P4 | 33 | KL119 | 21 |
| BIN36L | 233 | CM1107 | 110 | Group P4T | 33 | KL121 | 21 |
| BIN44 | 233 | CM1108 | 110 | HAL01 | 10 | KL123 | 21 |
| BIN44L | 233 | CM1125 | 111 | HAL02 | 10 | KL126 | 21 |
| C111 | 248 | CM1126 | 111 | HAL03 | 10 | KL127 | 21 |
| C135 | 248 | CM1127 | 111 | HAL04 | 10 | KL200 | 21 |
| C2220A | 249 | CM1128 | 111 | HAL05 | 10 | KL201 | 21 |
| C2222A | 249 | CM1400 | 115 | HAL06 | 10 | KL203 | 21 |
| C2222C | 249 | CM1401 | 115 | HAL09 | 10 | KL204 | 21 |
| C2222HD | 249 | CM1402 | 115 | HAL10 | 10 | KL205 | 21 |
| C2236 | 249 | CM1403 | 115 | HAL11 | 10 | KL350 | 21 |
| C2236H | 249 | CM1404 | 115 | HAL12 | 10 | KL444 | 160 |
| C2237 | 249 | CM1405 | 115 | HAL13 | 10 | KL800 | 21 |
| C32P1 | 248 | CM1406 | 115 | HAL14 | 10 | KL805 | 21 |
| C32P2 | 248 | CM1407 | 115 | HAL15 | 10 | KL920 | 21 |
| C35P | 248 | CM1408 | 115 | HAL16 | 10 | KL924 | 21 |
| C3620W | 165 | CP2036 | 316 | HAL17 | 10 | KL928 | 21 |
| C3625T | 165 | CT1014 | 157 | HAL18 | 10 | LB12 | 96 |
| C3630W | 165 | CT1216 | 157 | HAL20 | 10 | LB16 | 96 |
| C93 | 248 | CT1217 | 157 | HAL21 | 10 | LD1000N | 175 |
| CC11SH | 316 | CT1418 | 157 | HAL22 | 10 | LD250N | 175 |
| CC11TH | 316 | CT1713TR | 157 | HAL23 | 10 | LD350N | 177 |
| CC2036 | 316 | CW6C | 248 | HAL24 | 10 | LD500N | 175 |
| CC2036DP | 316 | DL1826 | 178 | HAL26 | 10 | LD500NSS | 177 |
| CC2036P | 316 | DL300 | 178 | HAL27 | 10 | MIN5440 | 38 |
| CC2243 | 316 | DL300R | 178 | HAL28 | 10 | MIN5441 | 38 |
| CD2036 | 316 | EAG01 | 88 | HAL31 | 10 | MIN5442 | 38 |
| CM1012 | 28, 115 | EAG02 | 88 | HAL32 | 10 | MIN5443 | 51 |
| CM1013 | 28, 115 | EAG04 | 88 | HL7237 | 197 | MIN5449 | 38 |
| CM1017 | 117 | EAG05 | 88 | HL7237PS | 197 | N44010 | 252 |
| CM10238Z | 112 | EAG06 | 88 | HL8185 | 197 | N44011 | 252 |
| CM10239Z | 112 | EAG07 | 88 | HL8185B | 197 | N44012 | 252 |
| CM10240Z | 112 | EAG08 | 88 | HL8185C | 197 | OP305 | 144 |
| CM10278Z | 112 | EAG09 | 88 | HL8185G | 197 | OP316 | 144 |
| CM10279Z | 112 | EAG10 | 88 | HL8185GB | 197 | OP371 | 144 |
| CM10280Z | 112 | EAG11 | 88 | HL8185GC | 197 | OSB172 | 97 |
| CM1030 | 116 | EP214 | 144 | HL8195 | 197 | OSB176 | 97 |
| CM10318Z | 112 | EP216 | 144 | HL8195B | 197 | OSB178 | 97 |
| CM10319Z | 112 | EP217 | 144 | HL8285 | 197 | P614 | 159 |
| CM1032 | 116 | GA55001 | 13 | HL8285B | 197 | P614R | 159 |
| CM1033 | 116 | GA55002 | 13 | HL8285G | 197 | PC140N | 177 |
| CM1033P | 116 | GA55003 | 13 | HL8285GB | 197 | PC160N | 177 |
| CM1035 | 116 | GA55008 | 13 | HLA20 | 197 | PC180N | 177 |
| CM1037 | 116 | GA55011 | 13 | IC2220 | 179 | PC300N | 176 |
| CM1040 | 113 | GA55012 | 13 | IC2250 | 179 | PC600N | 176 |

PRODUCT INDEX

| Prod No | Page No | Prod No | Page No | Prod No | Page No | Prod No | Page No |
|----------|---------|---------|---------|------------|---------|-----------|---------|
| PC660 | 176 | REW30S | 241 | RSP | 247 | SL6011TC | 103 |
| PCD205 | 24 | REW30SC | 241 | RST1520NSQ | 161 | SMMC10 | 105 |
| PCD206 | 24 | RF | 246 | RTP | 246 | SMMC12 | 105 |
| PCD207 | 24 | RFP | 247 | RW20 | 241 | SMO1624 | 105 |
| PCD209 | 24 | RG16 | 243 | RW20-C | 241 | SMR1624 | 105 |
| PCD210 | 24 | RG16-1 | 243 | RW20-1 | 241 | SMR1836 | 105 |
| PCD211 | 24 | RG16-1C | 243 | RW20-1C | 241 | SMR24 | 105 |
| PCD220 | 24 | RG16-2 | 243 | RW20-2 | 241 | SMTD24 | 105 |
| PCD305 | 24 | RG16-2C | 243 | RW20-2C | 241 | SPD123 | 127 |
| PCD308 | 24 | RG16-3 | 243 | RW20-3 | 241 | SPD300 | 127 |
| PCD310 | 24 | RG16-3C | 243 | RW20-3C | 241 | SPD300KD | 127 |
| PCD312 | 24 | RG16-4 | 243 | RW20-4C | 241 | SPD303 | 127 |
| PCD313 | 24 | RG16-4C | 243 | RW30 | 241 | SPD303KD | 127 |
| PCD316 | 24 | RG16-5 | 243 | RW30-C | 241 | SS105 | 141 |
| PCD319 | 24 | RG16-5C | 243 | RW30-1 | 241 | SSD100 | 131 |
| PCD412 | 24 | RG25 | 244 | RW30-1C | 241 | SSW1 | 103 |
| PCD796 | 24 | RG25-1 | 244 | RW30-2 | 241 | ST1532 | 230 |
| PCD801 | 160 | RG25-1C | 244 | RW30-2C | 241 | ST1544 | 230 |
| PS101CS | 142 | RG25-2 | 244 | RW30-3 | 241 | ST1556 | 230 |
| PS103 | 139 | RG25-2C | 244 | RW30-3C | 241 | ST1568 | 230 |
| PS103AT | 139 | RG25-3 | 244 | RW30-4C | 241 | ST1573 | 230 |
| PS203 | 139 | RG25-3C | 244 | S275 | 58 | ST1587 | 230 |
| PS204 | 138 | RG25-4 | 244 | S277 | 58 | ST1629 | 230 |
| PS204AST | 138 | RG25-4C | 244 | S279 | 58 | ST1630 | 230 |
| PS304 | 139 | RG25-5 | 244 | S280 | 58 | TC1826N | 177 |
| PS304AT | 139 | RG25-5C | 244 | S282 | 58 | TP100 | 131 |
| PS501N | 139 | RG36 | 245 | S285 | 58 | TTH100 | 333 |
| PS502N | 139 | RG36-1 | 245 | S286 | 58 | TTL100 | 333 |
| PS6012 | 139 | RG36-1C | 245 | S287 | 58 | TTL150 | 333 |
| PS601N | 139 | RG36-2 | 245 | S310 | 56 | TTL580 | 333 |
| PS601NC | 138 | RG36-2C | 245 | S312 | 56 | TTLD580 | 333 |
| PS602N | 139 | RG36-3 | 245 | S314 | 56 | TTS100 | 333 |
| PS603N | 139 | RG36-3C | 245 | SB66 | 97 | TTS150 | 333 |
| PS701B | 139 | RG36-4 | 245 | SB68 | 97 | TTS580 | 333 |
| PS702 | 139 | RG36-4C | 245 | SB70 | 97 | UC1940 | 318 |
| PS801B | 139 | RG36-5 | 245 | SB72 | 97 | UC3031524 | 317 |
| PS802 | 139 | RG36-5C | 245 | SB74 | 97 | UC3031827 | 317 |
| PSD13CH | 99 | RG49 | 245 | SB76 | 97 | UC4018 | 318 |
| PSD13EH | 99 | RG49-1 | 245 | SB78 | 97 | UC4031529 | 317 |
| PSD21CH | 99 | RG49-1C | 245 | SB79 | 97 | UC4031733 | 317 |
| PSD21DEH | 99 | RG49-2 | 245 | SB90 | 96 | UC4525 | 318 |
| PSD21EH | 99 | RG49-2C | 245 | SB94 | 96 | UC5031524 | 317 |
| RB | 246 | RG49-3 | 245 | SBC11SH | 317 | UC5031827 | 317 |
| RC16 | 247 | RG49-3C | 245 | SBC11TC | 317 | UC5032135 | 317 |
| RC16-1 | 247 | RG49-4 | 245 | SBC1521 | 315 | UC7022133 | 317 |
| RC20 | 247 | RG49-4C | 245 | SBC2031 | 315 | UC7032133 | 317 |
| RC20-1 | 247 | RG49-5C | 245 | SBC230 | 317 | UCC4018 | 318 |
| RDC | 249 | RG9 | 242 | SBCA30000 | 315 | UCC4525 | 318 |
| RDC1 | 249 | RG9-1 | 242 | SBCC240 | 315 | WB965 | 63 |
| RE | 242-246 | RG9-1C | 242 | SBCC245 | 315 | WPM25 | 145 |
| RE16 | 243 | RG9-2 | 242 | SBCRKIT | 315 | WPM45 | 145 |
| RE16C | 243 | RG9-2C | 242 | SBG1 | 103 | WPM85 | 145 |
| RE25 | 244 | RG9-3 | 242 | SC25 | 160 | XB5 | 172 |
| RE25C | 244 | RG9-3C | 242 | SC26 | 160 | XDL3000H | 178 |
| RE36 | 245 | RG9-4 | 242 | SC27 | 160 | XT10000 | 174 |
| RE36C | 245 | RG9-4C | 242 | SC29 | 160 | XT1400 | 173 |
| RE49 | 245 | RG9-5 | 242 | SC32 | 99 | XT1600 | 173 |
| RE49C | 245 | RG9-5C | 242 | SC40 | 160 | XT1800 | 173 |
| RE9 | 242 | RHC | 249 | SCL1 | 103 | XT2500 | 174 |
| RE9C | 242 | ROP | 246 | SD01 | 103 | XT3000R | 173 |
| REW20S | 241 | RP | 246 | SEA1 | 103 | XT5000 | 174 |
| REW20SC | 241 | RPC | 247 | SL6011L | 103 | | |

TERMS & CONDITIONS — Carlisle FoodService Products

1. Terms and Method of Payment

- a. All orders are subject to approval and acceptance by SELLER. No order accepted by SELLER shall be subject to cancellation, termination, suspension, change, reduction, cutback or other modification except with SELLER'S prior written consent.
- b. Our standard terms of payment are net 30 days from invoice date. The amount of terms of credit, if extended, may be changed or credit withdrawn by SELLER at any time. No orders will be shipped on a COD basis.
- c. Prices do not include federal, state or local taxes, duties or other levies, now or hereafter enacted, applicable to the items deliverable under the sales order or invoice (hereinafter called ITEMS), which taxes, duties, or other levies will be added by SELLER to the sales price and will be paid by BUYER unless BUYER provides SELLER with a proper exemption certificate.
- d. Packaging for commercial shipment is included in the contract price. Any special packaging, crating or shipping instructions must be noted on BUYER'S original order and acknowledged by SELLER.

2. Title and Delivery

The ITEMS shall be delivered F.O.B. SELLER'S plant, and title thereto shall pass to BUYER, upon SELLER'S delivery of the ITEMS to a common carrier for shipment to BUYER. All items from the Carlisle FoodService Products catalog may be combined to obtain prepaid freight, regardless of the shipping point. Freight is prepaid on all orders totaling \$3,000 net or more to one destination within the contiguous 48 United States. Freight on prepaid International Shipments will be paid on normal ground transportation from shipping point to the consignee. When the order qualifies for prepaid freight, Seller shall have the right to select the means of transportation. If Buyer requires a means of transportation other than the one normally selected by Seller, any extra cost incurred by reason of using such other means shall be paid by Buyer. Palletized international orders requiring heat treated pallets will be charged \$4.25 net per pallet. International orders requiring heat treated certified bark-free pallets will be charged \$18.50 net per pallet. Any accessorial charges incurred because of a customer request will be the responsibility of the requester. Any items backordered from a prepaid shipment will be forwarded prepaid. Items backordered from ex works shipments will be forwarded ex works.

3. Inspection and Acceptance

Thoroughly inspect all shipments. Do not accept a damaged or short shipment until exception is noted on the freight bill. BUYER will be held responsible for all shipments with freight bills signed free and clear. If concealed damage is discovered, contact the freight company immediately for inspection. Concealed damage must be reported to the carrier within 7 days of receipt. All damaged goods and shortages that are not properly documented and reported upon receipt become the sole responsibility of the BUYER.

4. Patent Indemnification

SELLER shall protect and indemnify BUYER and its directors, officers, agents and employees against all claims for damages or profits, including all reasonable costs incurred by BUYER in connection therewith, arising from infringement of patents, copyrights, trademarks or misappropriation of designs.

5. Returns and Cancellations

No returns will be accepted without an authorization number from Carlisle FoodService Products Customer Service. An authorization number may be obtained by calling 800-654-8210 and requesting a Return Authorization from Customer Service. All requests for return must occur within 90 days of the original shipment of the product unless special authorization is obtained. Merchandise returned without authorization will be refused and returned to the customer, freight collect.

Any merchandise must be returned freight prepaid, and is subject to a minimum of 15% restocking charge.

All returned goods must reference the original invoice and purchase order. Returned goods must be in original standard packs and in unused salable condition. Special Order Products and discontinued items will not be accepted for exchange or return. This includes any articles custom imprinted or modified for purchaser.

6. General

- a. All prices are list and subject to change without notice. Orders from authorized accounts will be accepted with the understanding that prices are those in effect at the time of shipment. These prices are exclusive of all sales taxes which may be levied by State, Federal, or City governments.
- b. Orders less than \$100.00 net will be charged a \$10.00 handling fee. The initial order requirement for a new customer is \$3,500 net, and must be accompanied by a tax exemption certificate.
- c. Orders calling for less than a standard case pack will be charged \$5.00 net each per broken case.
- d. Orders requiring 3rd party freight billing will be accessed a \$5.00 per order processing charge.
- e. All orders of custom products are subject to shipment of plus or minus 10% of the quantity ordered.
- f. No ITEMS to be furnished hereunder shall be exported by BUYER unless SELLER is first notified in writing of the intention to so export and all applicable regulations and licenses are complied with and obtained by BUYER or its customer.
- g. SELLER hereby certifies that the goods described herein of its manufacture will be produced in compliance with all applicable requirements of Sections 6, 7 and 12 of the Fair Labor Standards Act, as amended, and all order of the United States Department of Labor issued under Section 14 thereof. SELLER further certifies that it is in compliance with the Equal Employment Opportunity clause in Section 202, paragraphs 1 through 7 of Executive Order 11246, as amended, relative to equal employment opportunity and the implementing Rules and Regulations of the Office of Federal Contract Compliance.
- h. SELLER is not responsible for typographical errors made in any of its publications or for stenographic or clerical errors made in preparation of quotations, sales orders, acknowledgments, or invoices. All such errors are subject to correction.
- i. This agreement shall be governed by the laws of the state of Oklahoma.
- j. SELLER'S "Terms and Conditions" as set forth above shall govern all transactions. Any inconsistent terms of BUYER wherever set forth and whether oral or written, shall not be binding upon SELLER unless agreed to by SELLER in writing. No waiver or exception to any of the hereinabove enumerated conditions or any of the special terms and provisions relating to any order shall be binding upon SELLER unless agreed to in writing by SELLER.
- k. SELLER reserves the right to change or discontinue the color, design, component content or price of any ITEMS in SELLER'S catalog or published price lists without prior notice at any time.

The specifications and prices listed in this document are subject to change. Carlisle does not assume responsibility for typographical errors.
REV01/19



CFSBRANDS®

www.cfsbrands.com

©2019 CFS Brands
4711 East Hefner Road
Oklahoma City, OK 73131
Phone: 405.475.5600 | 800.654.8210
Toll Free Fax: 800.872.4701
Printed in USA

CAT2019FSP