

Spare Parts & Service



Spare Parts: 1300739996 spares@comcater.com.au
Service: 1800810161 service@comcater.com.au

MELBOURNE BRISBANE ADELAIDE PERTH SYDNEY

CAMBRO®

REPLACEMENT SPARE PARTS LIST

All Categories

 **Comcater Online Parts Store**

Always Genuine OEM Parts
For: Safety, Reliability,
Efficiency & Warranty





Replacement Parts List

COMCATER
-foodservice equipment-

Distributed by
Comcater Pty Ltd
156 Swann Drive
Derrimut VIC 3030
Phone: (03) 8369 4600
Fax: (03) 8369 4696
www.comcater.com.au



Beverage Dispenser and Pail with Bail



CODE	PART FITS C.G. THIS PRODUCT	DESCRIPTION
46017	DSPR6	1-White Faucet
13219	DSPR6	6-Imprinted Beverage Label Set
60022	DSPR6, PWB22 (Units Before 12/03)	1-Bail
46044	DSPR6, PWB22 (Units After 12/03)	1-Bail
RFSC12	DSPR6, PWB22	1-White Lid



Beverage Service Carts





foodservice equipment



Distributed by
Comcater Pty Ltd
 156 Swann Drive
 Derrimut VIC 3030
Phone: (03) 8369 4600
Fax: (03) 8369 4696
www.comcater.com.au

Casters

CODE	PART FITS C.G. THIS PRODUCT	DESCRIPTION	
60032	All Beverage Service Carts	1-6" Fixed Caster w/fasteners (60300)	██████████ ██████████
60033	All Beverage Service Carts	1-6" Swivel Caster w/Brake, and fasteners (60300)	██████████
60034	All Beverage Service Carts	1-6" Swivel Caster w/fasteners (60300)	██████████

Chassis Plates

CODE	PART FITS C.G. THIS PRODUCT	DESCRIPTION	
45702	MDC24	1-Chassis Plate	██████████ ██████████

Doors

CODE	PART FITS C.G. THIS PRODUCT	DESCRIPTION	
7317	All Beverage Service Carts	1- Door, 1-Gasket, 1-Vent Cap (14200) fits either left or right	██████████ ██████████ ██████████

Hinges

CODE	PART FITS C.G. THIS PRODUCT	DESCRIPTION	
60017	All Beverage Service Carts	1-Metal Hinge Kit, 1-Stainless Steel Hinge, 3-Screws (60311), 4-Screws (60317)	██████████ ██████████

Latches

CODE	PART FITS C.G. THIS PRODUCT	DESCRIPTION	
60121	All Beverage Service Carts	Metal Latch Kit: 1-Metal Latch, 4-Screws (60313)	██████████ ██████████

Gasket

CODE	PART FITS C.G. THIS PRODUCT	DESCRIPTION	
12123	All Beverage Service Carts	1-Door Gasket	██████████ ██████████

Vent Cap

CODE	PART FITS C.G. THIS PRODUCT	DESCRIPTION	
14200	All Beverage Service Carts (models before 01/07)	1-Vent Cap	██████████ ██████████
H07001	All Beverage Service Carts (models after 1/07)	1-Black Pop-up Vent	██████████

Booster Seats



Distributed by
Comcater Pty Ltd
 156 Swann Drive
 Derrimut VIC 3030
 Phone: (03) 8369 4600
 Fax: (03) 8369 4696
www.comcater.com.au

Bumper

CODE
47262

PART FITS THIS PRODUCT
 C.G. All Booster Seats
 (Units After 09/96)

DESCRIPTION
1-Cylinder Style Bumper



Buffet Bars/Free Standing Sneeze Guards

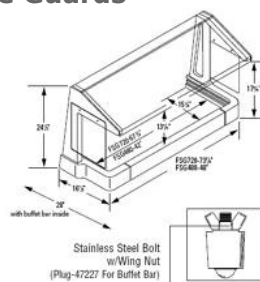

COMCATER
Foodservice equipment

Distributed by
Comcater Pty Ltd
 156 Swann Drive
 Derrimut VIC 3030
 Phone: (03) 8369 4600
 Fax: (03) 8369 4696
 www.comcater.com.au

Base Section

CODE	PART FITS C.G.THIS PRODUCT	DESCRIPTION
6991	4 BBR480, BBR720 (FSG)	1-Right-End Base Section
6990	4 BBR480, BBR720 (FSG)	1-Left-End Base Section
6992	4 BBR480 (FSG)	1-Center Base Section
6993	4 BBR720 (FSG)	1-Center Base Section

Hardware

CODE	PART FITS C.G.THIS PRODUCT	DESCRIPTION
60304	BBR480, BBR720 (FSG)	4-Knurled Thumb Bolt 1/4-20 x 3/4
60016	BBR480, BBR720 (FSG)	8-Wing Nuts, 8-Bolts
47101	BBR480, BBR720 (FSG)	1-Rubber Bumper
12303	BBR480, BBR720 (FSG)	1-Rubber "O" Ring for Upright Socket
60044	BBR480, BBR720 (FSG)	1-Bolt with Washer for Upright

Plug

CODE	PART FITS C.G.THIS PRODUCT	DESCRIPTION
47227	BBR480, BBR720, BUF48, BUF72	1-Plug

Sneeze Guards

CODE	PART FITS C.G.THIS PRODUCT	DESCRIPTION
64014	BBR480 (FSG)	1-Sneeze Guard Panel Shield
64015	BBR720 (FSG)	1-Sneeze Guard Panel Shield
64016	BBR480, BBR720 (FSG)	1-Side Panel Shield

Tension Support Rod

CODE	PART FITS C.G.THIS PRODUCT	DESCRIPTION
60188	BUF72	1-Rod, 2-Flat Head Phillips Screws (60325), 2-Flanged Washers (60342)

Uprights

CODE	PART FITS C.G.THIS PRODUCT	DESCRIPTION
6988	4 BBR480, BBR720 (FSG)	1-Left-Upright
6989	4 BBR480, BBR720 (FSG)	1-Right-Upright

Camcarrier®



-foodservice equipment-



Distributed by
Comcater Pty Ltd
156 Swann Drive
Derrimut VIC 3030
Phone: (03) 8369 4600
Fax: (03) 8369 4696
www.comcater.com.au

Doors

CODE	PART FITS C.G. THIS PRODUCT	DESCRIPTION
6971	1826MTC	1-Standard Door, 1-Gasket, 1-Vent Cap

Gasket

CODE	PART FITS C.G. THIS PRODUCT	DESCRIPTION
12119	1826MTC	1-Gasket

Hinges for Doors

CODE	PART FITS C.G. THIS PRODUCT	DESCRIPTION
60048	1826MTC	Hinge Kit: 1-Stainless Hinge, 3-Screws (60317), 3-Screws (60311)

Latches

CODE	PART FITS C.G. THIS PRODUCT	DESCRIPTION
H05021	1826MTC	1.6 Plastic Latch Kit: 1-Latch, 4 Screws

Vent Cap

CODE	PART FITS C.G. THIS PRODUCT	DESCRIPTION
14200	All Camcarriers	1-Vent Cap
H07001	All Camcarriers	1-Black Pop-up Vent

Camcarriers® - 100 Series Insulated Top Loading Carrier



Distributed by
Comcater Pty Ltd
 156 Swann Drive
 Derrimut VIC 3030
 Phone: (03) 8369 4600
 Fax: (03) 8369 4696
www.comcater.com.au

Gaskets

CODE	PART FITS C.G. THIS PRODUCT	DESCRIPTION	
12101	100MPCHL	1-Small Gasket for hinged lid	█
12108	100MPC, 100MPCHL, UPC100	1-Gasket	█
12109	UPC101	1-Gasket	█

Latches

CODE	PART FITS C.G. THIS PRODUCT	DESCRIPTION	
60212	UPC100, UPC101	Nylon Latch Kit: 1-4" Black Nylon, 4-Screws (60311)	█
60090	All Camcarriers	Metal Latch Kit: 1-Metal Latch, 1-Small 2 Hole Latch, 2-Screws (60315) Note: Mount plate has 6 holes, but is designed for 2-hole application.	█
60092	All Camcarriers	Metal Latch Kit: 1 Metal Latch, 1-Small 4 Hole Latch, 4-Screws (60315)	█
H05021	100MPC, 100MPCHL (Units after 5/1/06)	1.6 Plastic Latch Kit: 1-Latch, 4 Screws	█
60264	All Camcarriers, Except 100MPC, 100MPCHL	1-Small Plastic Latch 2 Hole, 2-Screws (60315)	█

Lids

CODE	PART FITS C.G. THIS PRODUCT	DESCRIPTION	
100HL	100MPCHL	1-Hinged Lid, 2-Hinge, 2-Gaskets, 1-Vent Cap	█
7637	100MPC*	1-Lid, 1-Gasket, 1-Vent Cap	█
6339	100MPCHL	1-Small Lid, 1-Gasket	█
6340	100MPCHL	1-Large Lid, 1-Gasket, 1-Vent Cap	█
7387	UPC100	1-Lid, 1-Gasket, 1-Vent Cap	█
C06001	UPC101	1-Lid, 1-Gasket	█

Vent Cap

CODE	PART FITS C.G. THIS PRODUCT	DESCRIPTION	
14200	All Camcarriers	1-Vent Cap	█
H07001	All Camcarriers	1-Black Pop-up Vent	█

* Units before 01/02 no longer available.

Camcarts® for Food Boxes and Trays/Sheet Pans



Distributed by
Comcater Pty Ltd
 156 Swann Drive
 Derrimut VIC 3030
 Phone: (03) 8369 4600
 Fax: (03) 8369 4696
www.comcater.com.au

Casters

CODE	PART FITS C.G.THIS PRODUCT	DESCRIPTION
60032	1826 Box & Tray Carts, All 1826 w/Security Package	1-6" Fixed Caster, w/fasteners (60300)
60033	1826 Box & Tray Carts, All 1826 w/Security Package	1-6" Swivel Caster w/Brake, and fasteners (60300)
60034	1826 Box & Tray Carts, All 1826 w/Security Package	1-6" Swivel Caster, w/fasteners (60300)
44018	1826 Box & Tray Carts, All 1826 w/Security Package	1" Caster Impact Plate for 5" and 6" casters
H11006	1826 Box & Tray Carts (SP models only)	1-6" X 1.5" Swivel Caster w/Brake, 4-Pin-in-Torx Bolts
H11005	1826 Box & Tray Carts (SP models only)	1-6" X 1.5" Swivel, No Brake, 4-Pin-in-Torx Bolts
H11004	1826 Box & Tray Carts (SP models only)	1-6" X 1.5" Rigid Caster, 4-Pin-in-Trox Bolts

Cutting Board

CODE	PART FITS C.G.THIS PRODUCT	DESCRIPTION
47103	1826LTC, 1826LBC, 1826LTC3, 1826LBCSP, 1826LTCSP	1-Cutting Board

Doors

CODE	PART FITS C.G.THIS PRODUCT	DESCRIPTION
6929	1826DBC	1-Top Standard Door, 1-Gasket, 1-Vent Cap
6930	1826DBC	1-Bottom Standard Door, Gasket, Vent Cap
6672	1826DTC	1-Top Standard Door, 1-Gasket, 1-Vent Cap
6673	1826DTC	1-Bottom Standard Door, 1-Gasket, 1-Vent Cap
6348	1826LBC, 1826LTC, 1826LTC3	1-Standard Door, 1-Gasket, 1-Vent Cap
6692	1826DBCSP	1-Top Standard Door, 1-Gasket, 1-Vent Cap
6693	1826DBCSP	1-Bottom Standard Door, 1-Gasket, 1-Vent Cap
6694	1826DTCSP	1-Top Standard Door, 1-Gasket, 1-Vent Cap
6695	1826DTCSP	1-Bottom Standard Door, 1-Gasket, 1-Vent Cap
6696	1826LBCSP, 1826LTCSP	1-Standard Door, 1-Gasket, 1-Vent Cap

Gaskets

CODE	PART FITS C.G.THIS PRODUCT	DESCRIPTION
12111	1826LBC, 1826LTC, 1826LTC3, 1826LBCSP, 1826LTCSP	1-Gasket
12115	1826DBC, 1826DTC, 1826DBCSP, 1826DTCSP	1-Gasket

Hinges for Doors

CODE	PART FITS C.G.THIS PRODUCT	DESCRIPTION
60048	1826DBC, 1826DTC, 1826LTC, 1826LTC3, 1826MTC, 1826LBC	Hinge Kit: 1-Stainless Hinge, 3-Screws (60317), 3-Screws (60311)

Latches

CODE	PART FITS C.G.THIS PRODUCT	DESCRIPTION
H05021	1826LTC, 1826LTC3, 1826DTC, 1826DBC, 1826LBC	1.6 Plastic Latch Kit: 1-Latch, 4 Screws
60063	1826DTCSP, 1826DBCSP, 1826LTCSP, 1826LBCSO	1-Latch Welded Bail, 4-Screws

Vent Caps

CODE	PART FITS C.G.THIS PRODUCT	DESCRIPTION
14200	All Camcarts	1-Vent Cap
H07001	All Camcarts	1-Black Pop-up Vent

Camchiller® Cart

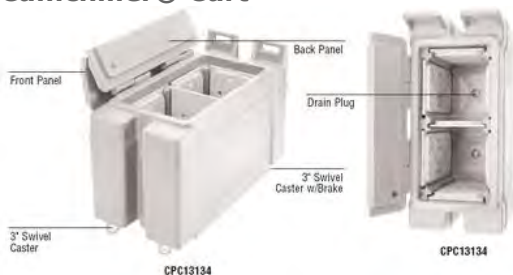

Distributed by
Comcater Pty Ltd
 156 Swann Drive
 Derrimut VIC 3030
 Phone: (03) 8369 4600
 Fax: (03) 8369 4696
www.comcater.com.au

Caster Impact Plate

CODE	PART FITS C.G. THIS PRODUCT	DESCRIPTION
44018	CPC13134, CPC13134A	1-3" Caster Impact Plate



Casters

CODE	PART FITS C.G. THIS PRODUCT	DESCRIPTION
60352	CPC13134	1-3" Swivel Caster, 4-Bolts (60300)
60040	CPC13134	1-3" Swivel w/Brake Caster, 4-Bolts (60300)
60007	CPC13134A	1-5" Swivel w/Brake Caster, 4-Bolts (60300)



Covers

CODE	PART FITS C.G. THIS PRODUCT	DESCRIPTION
6361	23 CPC13134, CPC13134A	Front Panel (with logo)
6362	23 CPC13134, CPC13134A	Back Panel (attached to body)



Drain Plug

CODE	PART FITS C.G. THIS PRODUCT	DESCRIPTION
60030	CPC13134, CPC13134A	1-Plug, 1-Adapter, 1-"O" Ring



Camwarmer®

CODE	PART FITS C.G. THIS PRODUCT	DESCRIPTION



Camcrisper®



Distributed by
Comcater Pty Ltd
 156 Swann Drive
 Derrimut VIC 3030
 Phone: (03) 8369 4600
 Fax: (03) 8369 4696
www.comcater.com.au

Drain Shelf

CODE	C.G. THIS PRODUCT	PART FITS	DESCRIPTION
69319	CC32	CC32	1-Drain Shelf

Caster

CODE	C.G. THIS PRODUCT	PART FITS	DESCRIPTION
60005	CC32	CC32	1-Front 3" Swivel Caster, 4-Bolts (60303)
60009	CC32	CC32	1-Rear 3" Fixed Caster, 4-Bolts (60303)

Lids

CODE	C.G. THIS PRODUCT	PART FITS	DESCRIPTION
1B32LIDCW	CC32	CC32	1-Lid

Threaded Faucet Drain

CODE	C.G. THIS PRODUCT	PART FITS	DESCRIPTION
60222	Camcrisper	Camcrisper	1-Threaded Faucet Drain, 1-"O" Ring, 1-Jam Nut

Umbrellas

CODE	PART FITS C.G.THIS PRODUCT	DESCRIPTION
14321	CVC55	1-Umbrella, Green and White
14322	CVC55	1-Umbrella, Red and White
14325	CVC55	1-Umbrella, Blue and White
14324	CVC55	1-Umbrella, Black and White





Distributed by
Comcater Pty Ltd
156 Swann Drive
Derrimut VIC 3030
Phone: (03) 8369 4600
Fax: (03) 8369 4696
www.comcater.com.au

Umbrella Locator

CODE	PART FITS C.G.THIS PRODUCT	DESCRIPTION
14512	CVC55	1-Umbrella Locator



Camcruisers® CVC72 and CVC724



Distributed by
Comcater Pty Ltd
 156 Swann Drive
 Derrimut VIC 3030
 Phone: (03) 8369 4600
 Fax: (03) 8369 4696
www.comcater.com.au

Acrylic Panel

CODE	PART FITS C.G.THIS PRODUCT	DESCRIPTION
47168	CVC72, CVC724	1-Clear Acrylic Panel

Cash Box

CODE	PART FITS C.G.THIS PRODUCT	DESCRIPTION
14508	CVC72, CVC724	1-Cash Box

Cash Drawer

CODE	PART FITS C.G.THIS PRODUCT	DESCRIPTION
14602	CVC72, CVC724	1-Cash Drawer

Casters

CODE	PART FITS C.G.THIS PRODUCT	DESCRIPTION
60259	CVC72, CVC724	1-8" Swivel w/Brake, 4-Bolts (60305), 4-Hex Nuts

Caster Mounting Plate

CODE	PART FITS C.G.THIS PRODUCT	DESCRIPTION
60274	CVC72, CVC724	1-Mounting Plate, 8-Bolts (60306), 8-Washers (60338)

Door

CODE	PART FITS C.G.THIS PRODUCT	DESCRIPTION
7351	2 CVC72, CVC724	1-Door, Gasket, 1-Vent Cap (14200), 2-Pivot Hinges, 12-Screws, 12-Washers

Front Display Panels

CODE	PART FITS C.G.THIS PRODUCT	DESCRIPTION
60059	CVC72, CVC724	1-"Campus Cuisine" Display Panel Red, 4-Screws (60316), 4-Washers (60337)
60060	CVC72, CVC724	1-"Campus Cuisine" Display Panel Black, 4-Screws (60316), 4-Washers (60337)
60061	CVC72, CVC724	1-"Campus Cuisine" Display Panel Green, 4-Screws (60316), 4-Washers (60337)
60110	CVC72, CVC724	1-"Campus Cuisine" Display Panel Blue, 4-Screws (60316), 4-Washers (60337)
60127	CVC72, CVC724	1-Plain Display Panel, 4-Screws (60316), 4-Washers (60337)

Gasket

CODE	PART FITS C.G.THIS PRODUCT	DESCRIPTION
12129	CVC72, CVC724	1-Gasket

Hinges

CODE	PART FITS C.G.THIS PRODUCT	DESCRIPTION
60053	CVC72, CVC724	Hinge Kit: 1-Right Bottom or Left Top Hinge, 6-Screws (60311), 6-Washers (60339)
60054	CVC72, CVC724	Hinge Kit: 1-Left Bottom or Right Top Hinge, 6-Screws (60311), 6-Washers (60339)

Latch

CODE	C.G.PART FITS THIS PRODUCT	DESCRIPTION
H05021	CVC72, CVC724	1-6 Plastic Latch Kit: 1-Latch, 4-Screws
60094	CVC72, CVC724 (UnitsLatch Kit: 1-Large Metal 4 Hole Latch, 4-Screws (60315) before 11/21/05)	



foodservice equipment

Distributed by
Comcater Pty Ltd
156 Swann Drive
Derrimut VIC 3030
Phone: (03) 8369 4600
Fax: (03) 8369 4696
www.comcater.com.au



Menu Boards

CODE	PART FITS C.G.THIS PRODUCT	DESCRIPTION
60275	CVC72, CVC724	1-Writing Board, 6-Grommets (60298), 6-Grommet Pins (60299)
7325	2 CVC72, CVC724	1-Writing Board, 1-Writing Board Holder, 6-Grommets (60298), 6-Grommet Pins (60299)

Top Shelf

CODE	PART FITS C.G.THIS PRODUCT	DESCRIPTION
6689	2 CVC72, CVC724	1-Top
60181	CVC72, CVC724	1-Clip Plate, 6-Screws (60309), 3-Star Washers (60339)

Umbrellas

CODE	PART FITS C.G.THIS PRODUCT	DESCRIPTION
60103	CVC72, CVC724	1-Umbrella Red and White w/Extension Pole
60104	CVC72, CVC724	1-Umbrella Green and White w/Extension Pole
60105	CVC72, CVC724	1-Umbrella Black and White w/Extension Pole
60106	CVC72, CVC724	1-Umbrella Blue and White w/Extension Pole

Upright

CODE	PART FITS C.G.THIS PRODUCT	DESCRIPTION
6690	2 CVC72, CVC724	1-Upright

Vent Caps

CODE	PART FITS C.G.THIS PRODUCT	DESCRIPTION
14200	CVC72, CVC724 (models before 1/07)	1-Vent Cap
H07001	CVC72, CVC724 (models after 1/07)	1-Black Pop-up Vent

Camdollies®



foodservice equipment



Distributed by
Comcater Pty Ltd
 156 Swann Drive
 Derrimut VIC 3030
Phone: (03) 8369 4600
Fax: (03) 8369 4696
www.comcater.com.au

Axles

CODE	PART FITS C.G. THIS PRODUCT	DESCRIPTION
60076	CD1826HB	1-Axle, 2-Nuts & Mount Bolts w/Washers
60077	CD2020HB	1-Axle, 2-Nuts & Mount Bolts w/Washers
60078	CD1826MTCHB	1-Axle, 2-Nuts & Mount Bolts w/Washers
60081	CD100HB, CD300HB	1-Axle, 2-Nuts & Mount Bolts w/Washers

Casters & Wheels

CODE	PART FITS C.G. THIS PRODUCT	DESCRIPTION
S12003	CDR2020, CDR2020H	1- 3 1/2" Swivel Caster w/Brake (each caster needs to be paired with 1 Bushing Sleeve, sold separately)
41020	All Easy Wheel Camdollies w/10" wheels	1-10" Wheel
60352	CD2020, CD2020H, CD1420, CD2028, CD1313, CD1327	1-3" Swivel Caster, 4-Bolts (60300)
60006	CD1826H, CD100, CD100H, CD160, CD300, CD300H, CD400, CD1826MTC, CD1826PDB	1-5" Fixed Caster, 4-Bolts (60300)
60007	CD1826H, CD100, CD100H, CD160, CD300, CD300H, CD400, CD1826MTC, CD1826PDB, CD2020HB	1-5" Swivel w/Brake Caster, 4-Bolts (60300)
60008	CD1826H, CD100, CD100H, CD160, CD300, CD300H, CD400, CD1826MTC, CD1826PDB, CD2020HB	1-5" Swivel Caster, 4-Bolts (60300)
41064	CDR2020, CDR2020H	1-3 1/2" Swivel Caster (each caster needs to be paired with 1 Bushing Sleeve, sold separately)
41059	CDR2020, CDR2020H	1-Bushing Sleeve

Handles

CODE	PART FITS C.G. THIS PRODUCT	DESCRIPTION
60232	CDR2020H	Handle Kit: 1-Chrome Handle, 4-Screws (60333)

Impact Plate

CODE	PART FITS C.G. THIS PRODUCT	DESCRIPTION
60284	CD400, CD1826PDB	1-Impact Plate, 4-Bolts (60300)

CamKiosk® System (Main Cart)



Distributed by
Comcater Pty Ltd
 156 Swann Drive
 Derrimut VIC 3030
 Phone: (03) 8369 4600
 Fax: (03) 8369 4696
www.comcater.com.au

Bridge Connectors for Top/Front Panel

CODE	C.G. THIS PRODUCT	DESCRIPTION	
PART FITS			
60198	1 All CamKiosk Carts	1-Clamp Section Roto Piece, 2-Arm Knob	
60199	All CamKiosk Carts	1-Three Lobe Knob, 3-Stainless Steel Fender Washers (60335)	
60200	All CamKiosk Carts	1-Strap/Bracket, 2-Thumb Screw (60328), 2-Star Washer (60343)	
7378	1 All CamKiosk Carts	1-Top Connector Panel (Bridge)	
7379	1 All CamKiosk Carts	1-Front Connector Panel (Bridge)	

Casters

CODE	C.G. THIS PRODUCT	DESCRIPTION	
PART FITS			
H08001	CamKiosk Carts after May 2011	1-Caster 6" Swivel, 4-Bolts (60300)	
H08002	CamKiosk Carts after May 2011	1-Caster 6" Swivel w/Brake, 4-Bolts (60300)	
60033	CamKiosk Carts prior to May 2011	1-Caster 6" Swivel w/Brake, w/fasteners (60300)	
60034	All CamKiosk Carts prior to May 2011	1-Caster 6" Swivel, w/fasteners (60300)	

Canopies & Umbrellas

CODE	C.G. THIS PRODUCT	DESCRIPTION	
PART FITS			
45251	All CamKiosk Carts	1-Slotted Set Screw	
60231	All CamKiosk Carts	1-Bushing, 1-Set Screw (60330)	
47283	All CamKiosk Carts	1-Canopy Pole 49" Length (units before 12/01/06)	
S06005	KVC854C, KVC856C	1-Telescoping Pole	
H06005	KVC854C, KVC856C	Retrofit & Replacement Kit: 4-Telescoping Poles, 1-Top Sneeze Guard Panel (Units after 12/01/06)	
42140	All CamKiosk Carts	1-Black Nylon Pole Bushing	
60413	All CamKiosk Carts	4-Spade Thumb Screw	
60207	All CamKiosk Carts	1-Canopy Beige #522 4-49" Poles	
60208	All CamKiosk Carts	1-Canopy Green #562 4-49" Poles	
14330	All CamKiosk Carts	1-Umbrella 6' Dia. Green/Beige	

Cash Box

CODE	C.G. THIS PRODUCT	DESCRIPTION	
PART FITS			
14508	All CamKiosk Carts	1-Metal Cash Box	
14602	All CamKiosk Carts	1-Cash Drawer	

Counter Top Knob





CODE	C.G. THIS PRODUCT	DESCRIPTION	
PART FITS			
46038	All CamKiosk Carts	1-Three Lobe Knob w/Stud	

Display Board

CODE	C.G. THIS PRODUCT	DESCRIPTION	
PART FITS			
60204	All CamKiosk Carts	1-Display Board, 4-Screws (60316), 4-Flange Washers (60337)	

Doors

CODE	C.G. THIS PRODUCT	DESCRIPTION	
PART FITS			
7370	1 All CamKiosk Carts	Left Door w/Hardware: 1-Left Door, 1-Gasket (12132), 1-Vent Cap (14200), 2-Pivot Pin (42128B), 1-3" Hinge Pin (42238), 1-Pin Lock Clip (42133), 1-Bushing Sleeve	
7372	1 All CamKiosk Carts	Right Door w/Hardware: 1-Right Door, 1-Gasket (12132), 1-Vent Cap (14200), 2-Pivot Pin (42128B), 1-3" Hinge Pin (42238), 1-Pin Lock Clip (42133), 1-Bushing Sleeve	
7371	1 All CamKiosk Carts	Center Door w/Hardware: 1-Center Door, 1-Latch Slam Action, 2-Latch Mount Clip (47284), 2-Latch Cover Plate, 2-Acorn Nut-	

		Nylon (45420), 2-Pivot Pin (42128B), 1-3" Hinge Pin (42238), 1-Pin Lock Clip (42133), 1-Bushing Sleeve	
47284	All CamKiosk Carts	1-Latch Clip for doors	
12132	All CamKiosk Carts	1-Gasket for left and right doors	
45420	All CamKiosk Carts	1-Nut for center door only	





foodservice equipment





Distributed by
Comcater Pty Ltd
156 Swann Drive
Derrimut VIC 3030
Phone: (03) 8369 4600
Fax: (03) 8369 4696
www.comcater.com.au



Latches

PART FITS			
CODE	C.G. THIS PRODUCT	DESCRIPTION	
60135	All CamKiosk Carts	1-Latch Black Nylon, 5-Screws (60311)	
60201	All CamKiosk Carts	Center Door Latch: 1-Latch (Slam Action), 2-Mount Clips (47284), 2-Jam Nuts	
60172	All CamKiosk Carts	Center Door Latch Plate: 1-Latch Strike Plate, 2-Screws (60311), 2-Star Washers (60339)	





Menu Board

PART FITS			
CODE	C.G. THIS PRODUCT	DESCRIPTION	
60206	All CamKiosk Carts	1-Menu Board, 2-Pole Mount Clip (60348), 2-Pan Head Screws (60329), 2-Thumb Nuts (60350)	

Shelf

PART FITS			
CODE	C.G. THIS PRODUCT	DESCRIPTION	
7369	1 All CamKiosk Carts	1-Horizontal Shelf Section	
60265	All CamKiosk Carts	3-Top Shelf Nylon Thumb Screw	



Sneeze Guard/Panels

PART FITS			
CODE	C.G. THIS PRODUCT	DESCRIPTION	
47289	All CamKiosk Carts	1-Sneeze Guard Bottom Clear Panel	
47279	All CamKiosk Carts	1-Sneeze Guard Top Clear Panel	
47280	All CamKiosk Carts	1-Sneeze Guard Bottom Clear Panel	
47292	All CamKiosk Carts	1-Center Pole Black Top End Cap	



Temperature Gauges

PART FITS			
CODE	C.G. THIS PRODUCT	DESCRIPTION	
60202F	All CamKiosk Carts- Fahrenheit	1-Fahrenheit Temperature Gauge unit, 4-Screws (60313)	
60202C	All CamKiosk Carts- Centigrade	1-Centigrade Temperature Gauge unit, 4-Screws (60313)	
60203	All CamKiosk Carts	2-Wire & Probe Clips w/Screws, 2-Probe Clips, 2-Wire Clamps (14616), 4-Pan Head Screws (60323)	
14616	All CamKiosk Carts	1-Clip Wire for temperature gauge	

Vent Caps

PART FITS			
CODE	C.G. THIS PRODUCT	DESCRIPTION	
14200	All CamKiosk Carts (models before 01/07)	1-Vent Cap	
H07001	All CamKiosk Carts (models after 1/07)	1-Black Pop-up Vent	

Well Tops

PART FITS			
CODE	C.G. THIS PRODUCT	DESCRIPTION	
7367	1 All CamKiosk Carts	4 Well Compartment Top	
7368	1 All CamKiosk Carts	6 Well Compartment Top	

Camrack® Flatware Basket Handles

Handles

CODE	PART FITS C.G.THIS PRODUCT	DESCRIPTION
46033	8FB434	1-Handle



COMCATER
foodservice equipment



Distributed by
Comcater Pty Ltd
156 Swann Drive
Derrimut VIC 3030
Phone: (03) 8369 4600
Fax: (03) 8369 4696
www.comcater.com.au

CamServers®

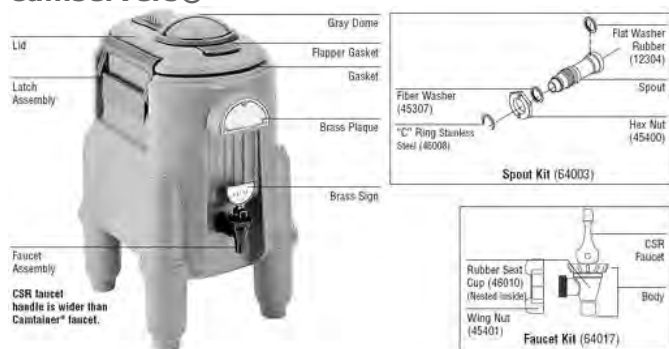

COMCATER
-foodservice equipment-

Distributed by
Comcater Pty Ltd
156 Swann Drive
Derrimut VIC 3030
Phone: (03) 8369 4600
Fax: (03) 8369 4696
www.comcater.com.au



Brass Plaque

CODE	PART FITS C.G. THIS PRODUCT	DESCRIPTION
60126	All CSR CamServers	1-Brass Plaque, 1-Adhesive Backing



Brass Signs

CODE	PART FITS C.G. THIS PRODUCT	DESCRIPTION
14514	All CSR CamServers	1-Coffee/Decaf Brass Sign
14518	All CSR CamServers	1-Tea/Hot Water Brass Sign



Faucet and Spout

CODE	PART FITS C.G. THIS PRODUCT	DESCRIPTION
64017	All CSR CamServers	Faucet Kit: 1- Assembled faucet body w/ CSR style lever (Brass sign clip not included); 1 - wing nut
64003	All CSR CamServers	Spout Kit: 1 - Spout sleeve; 1 - Hex nut; 1 - rubber washer seal (for inside container); 1 - Fiber washer (for outside container); 1- "C" Ring (for locking faucet & wing nut to spout assembly)
46010	All CSR CamServers	1-Silicone Rubber Seat Cup for Faucet
12307	All CSR CamServers	1-Flat Silicone Washer
45400	All CSR CamServers	1-Hex Nut
45307	All CSR CamServers	1-Fiber Washer
45401A	All CSR CamServers	1-Wing Nut
46008	All CSR CamServers	1-"C" Ring

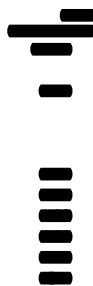

Latch

CODE	PART FITS C.G. THIS PRODUCT	DESCRIPTION
60257	All CSR CamServers	1-Latch, 6-Screws (60311)



Lid

CODE	PART FITS C.G. THIS PRODUCT	DESCRIPTION
7328	6 All CSR CamServers	1-Lid, 1-Gasket, 1-Gray Dome, 1-Flapper Gasket (Fits 3 & 5 Gallon)
12125	All CSR CamServers	1-Flapper Gasket
12127	All CSR CamServers	1-Gasket (Fits 3 & 5 Gallon)
14515	All CSR CamServers	1-Gray Dome



Plug Kit

CODE	PART FITS C.G. THIS PRODUCT	DESCRIPTION
H14004	All CSR CamServers	Camtainer Plug Kit: Plug, Washers, Hex Nuts



Camshelving Basics Series











foodservice equipment































Distributed by
Comcater Pty Ltd
156 Swann Drive
Derrimut VIC 3030
Phone: (03) 8369 4600
Fax: (03) 8369 4696
www.comcater.com.au





















Posts

CODE	PART FITS C.G. THIS PRODUCT	DESCRIPTION	
CBP64	CBPK1864580,	1 - Basics 64" Post	
	CBPK2164580,		
	CBPK2464580		
CBP72	CBPK1872580,	1 - Basics 72" Post	
	CBPK2172580,		
	CBPK2472580		
CBP84	CBPK1884580,	1 - Basics 84" Post	
	CBPK2184580,		
	CBPK2484580		

Traverses

CODE	PART FITS C.G. THIS PRODUCT	DESCRIPTION	
CBTR30	CBSK1830V580,	1 - Basics Traverse 30"	
	CBSK2130V580,		
	CBSK2430V580		
CBTR36	CBSK1836V580,	1 - Basics Traverse 36"	
	CBSK2136V580,		
	CBSK2436V580,		
	CBU183672580,		
	CBU213672580,		
CBTR42	CBSK1842V580,	1 - Basics Traverse 42"	
	CBSK2142V580,		
	CBSK2442V580,		
	CBU184272580,		
	CBU214272580,		
CBTR48	CBSK1848V580,	1 - Basics Traverse 48"	
	CBSK2148V580,		
	CBSK2448V580,		
	CBU184872580,		
	CBU214872580,		
CBTR54	CBSK1854V580,	1 - Basics Traverse 54"	
	CBSK2154V580,		
	CBSK2454V580,		
	CBU185472580,		
	CBU215472580,		
CBTR60	CBSK1860V580,	1 - Basics Traverse 60"	
	CBSK2160V580,		
	CBSK2460V580,		
	CBU186072580,		
	CBU216072580,		

Top Post Connectors



CODE	PART FITS C.G. THIS PRODUCT	DESCRIPTION	
CBPCT18	CBPK1864580,	1 - Top Corner Connector for 18"	
	CBPK1872580,		
	CBPK1884580,		
	CBU183672580,		
	CBU184272580,		
	CBU184872580,		
	CBU185472580,		
CBPCT21	CBU186072580	1 - Top Corner Connector for 21"	
	CBPK2164580,		
	CBPK2172580,		
	CBPK2184580,		
	CBU213672580,		
	CBU214272580,		
	CBU214872580,		
CBPCT24	CBU215472580,	1 - Top Corner Connector for 24"	
	CBU216072580		
	CBPK2464580,		
	CBPK2472580,		
	CBPK2484580,		
	CBU243672580,		
	CBU244272580,		

Bottom Post Connectors

CODE	PART FITS C.G. THIS PRODUCT	DESCRIPTION	
CBPCB18	CBPK1864580,	1 - Bottom Post Connector for 18"	
	CBPK1872580,		
	CBPK1884580,		



Distributed by
Comcater Pty Ltd
 156 Swann Drive
 Derrimut VIC 3030
 Phone: (03) 8369 4600
 Fax: (03) 8369 4696
www.comcater.com.au

CBPCB21	CBU183672580, CBU184272580, CBU184872580, CBU185472580, CBU186072580	1 - Bottom Post Connector for 21"				
	CBPK2164580, CBPK2172580, CBPK2184580, CBU213672580, CBU214272580, CBU214872580, CBU215472580, CBU216072580					
	CBPCB24			1 - Bottom Post Connector for 24"		
						CBPK2464580, CBPK2472580, CBPK2484580, CBU243672580, CBU244272580, CBU244872580, CBU245472580, CBU246072580, CBA244872580

Collar Wedge, Dovetails, Corner Connectors

PART FITS		
CODE	C.G. THIS PRODUCT	DESCRIPTION
CBPCW8	For all Basics Starter Units	8 each - Collar Wedges (4 each A, 4 each B)
CBTD8	For all Basics Starter Units	8 each - Traverse Dovetails (4 each A, 4 each B)
CBCCCL	For all Basics Starter Units	1 - Left Corner Connector
CBCCR	For all Basics Starter Units	1 - Right Corner Connector

Shelf Plates - Vented

PART FITS										
CODE	C.G. THIS PRODUCT	DESCRIPTION								
CBSP186V	CBSK1830V580, CBSK1842V580, CBSK1854V580, CBSK2130V580, CBSK2142V580, CBSK2154V580, CBSK2430V580, CBSK2442V580, CBSK2454V580, CBU184272580, CBU185472580, CBU214272580, CBU215472580, CBU244272580, CBU245472580	1 each - 18" x 6" Vented Shelf Plate								
	CBSP1811V			CBSK1830V580, CBSK1836V580, CBSK1842V580, CBSK1848V580, CBSK1854V580, CBSK1860V580, CBSK2130V580, CBSK2136V580, CBSK2142V580, CBSK2148V580, CBSK2154V580, CBSK2160V580, CBSK2430V580, CBSK2436V580, CBSK2442V580, CBSK2448V580, CBSK2454V580, CBSK2460V580, CBU183672580, CBU184272580, CBU184872580, CBU185472580, CBU186072580, CBU213672580, CBU214272580, CBU214872580, CBU215472580, CBU216072580, CBU243672580, CBU244272580, CBU244872580, CBU245472580, CBU246072580, CBA244872580	1 each - 18" x 11" Vented Shelf Plate					
							CBSP1812V	CBSK1836V580, CBSK1842V580, CBSK1848V580, CBSK1854V580, CBSK1860V580,	1 each - 18" x 12" Vented Shelf Plate	

COMCATER
foodservice equipment





Distributed by
Comcater Pty Ltd
 156 Swann Drive
 Derrimut VIC 3030
 Phone: (03) 8369 4600
 Fax: (03) 8369 4696
www.comcater.com.au

	CBSK2142V580, CBSK2148V580, CBSK2154V580, CBSK2160V580, CBSK2436V580, CBSK2442V580, CBSK2448V580, CBSK2454V580, CBSK2460V580, CBU183672580, CBU184272580, CBU184872580, CBU185472580, CBU186072580, CBU213672580, CBU214272580, CBU214872580, CBU215472580, CBU216072580, CBU243672580, CBU244272580, CBU244872580, CBU245472580, CBU246072580, CBA244872580		
CBSP216V	CBSK1830V580, CBSK1842V580, CBSK1854V580, CBSK2130V580, CBSK2142V580, CBSK2154V580, CBSK2430V580, CBSK2442V580, CBSK2454V580, CBU184272580, CBU185472580, CBU214272580, CBU215472580, CBU244272580, CBU245472580	1 each - 21" x 6" Vented Shelf Plate	
CBSP2111V	CBSK1830V580, CBSK1836V580, CBSK1842V580, CBSK1848V580, CBSK1854V580, CBSK1860V580, CBSK2130V580, CBSK2136V580, CBSK2142V580, CBSK2148V580, CBSK2154V580, CBSK2160V580, CBSK2430V580, CBSK2436V580, CBSK2442V580, CBSK2448V580, CBSK2454V580, CBSK2460V580, CBU183672580, CBU184272580, CBU184872580, CBU185472580, CBU186072580, CBU213672580, CBU214272580, CBU214872580, CBU215472580, CBU216072580, CBU243672580, CBU244272580, CBU244872580, CBU245472580, CBU246072580, CBA244872580	1 each - 21" x 11" Vented Shelf Plate	
CBSP2112V	CBSK1836V580, CBSK1842V580, CBSK1848V580, CBSK1854V580, CBSK1860V580, CBSK2142V580, CBSK2148V580, CBSK2154V580, CBSK2160V580, CBSK2436V580, CBSK2442V580, CBSK2448V580, CBSK2454V580, CBSK2460V580, CBU183672580, CBU184272580, CBU184872580, CBU185472580, CBU186072580, CBU213672580, CBU214272580, CBU214872580, CBU215472580, CBU216072580, CBU243672580, CBU244272580, CBU244872580, CBU245472580, CBU246072580, CBA244872580	1 each - 21" x 12" Vented Shelf Plate	



Distributed by
Comcater Pty Ltd
 156 Swann Drive
 Derrimut VIC 3030
 Phone: (03) 8369 4600
 Fax: (03) 8369 4696
www.comcater.com.au

	CBU214272580, CBU214872580, CBU215472580, CBU216072580, CBU243672580, CBU244272580, CBU244872580, CBU245472580, CBU246072580, CBA244872580		
CBSP246V	CBSK1830V580, CBSK1842V580, CBSK1854V580, CBSK2130V580, CBSK2142V580, CBSK2154V580, CBSK2430V580, CBSK2442V580, CBSK2454V580, CBU184272580, CBU185472580, CBU214272580, CBU215472580, CBU244272580, CBU245472580	1 each - 24" x 6" Vented Shelf Plate	
CBSP2411V	CBSK1830V580, CBSK1836V580, CBSK1842V580, CBSK1848V580, CBSK1854V580, CBSK1860V580, CBSK2130V580, CBSK2136V580, CBSK2142V580, CBSK2148V580, CBSK2154V580, CBSK2160V580, CBSK2430V580, CBSK2436V580, CBSK2442V580, CBSK2448V580, CBSK2454V580, CBSK2460V580, CBU183672580, CBU184272580, CBU184872580, CBU185472580, CBU186072580, CBU213672580, CBU214272580, CBU214872580, CBU215472580, CBU216072580, CBU243672580, CBU244272580, CBU244872580, CBU245472580, CBU246072580, CBA244872580	1 each - 24" x 11" Vented Shelf Plate	
CBSP2412V	CBSK1836V580, CBSK1842V580, CBSK1848V580, CBSK1854V580, CBSK1860V580, CBSK2142V580, CBSK2148V580, CBSK2154V580, CBSK2160V580, CBSK2436V580, CBSK2442V580, CBSK2448V580, CBSK2454V580, CBSK2460V580, CBU183672580, CBU184272580, CBU184872580, CBU185472580, CBU186072580, CBU213672580, CBU214272580, CBU214872580, CBU215472580, CBU216072580, CBU243672580, CBU244272580, CBU244872580, CBU245472580, CBU246072580, CBA244872580	1 each - 24" x 12" Vented Shelf Plate	

Camshelving® Elements Series



Distributed by
Comcater Pty Ltd
 156 Swann Drive
 Derrimut VIC 3030
 Phone: (03) 8369 4600
 Fax: (03) 8369 4696
www.comcater.com.au



Posts-Stationary

CODE	C.G. HEIGHT (IN)	HEIGHT (MM)
EP64	64"	1630
EP72	72"	1830
EP84	84"	2140



Post-Mobile

CODE	C.G. HEIGHT (IN)	HEIGHT (MM)
EMP70	70"	1778
EMP78	78"	1980



Stationary Traverses

CODE	C.G. WIDTH (IN)	WIDTH (MM)
ETR36	36"	910
ETR42	42"	1070
ETR48	48"	1220
ETR54	54"	1380
ETR60	60"	1530
ETR72	72"	1830
ETR78	78"	1980

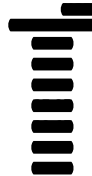

Mobile Traverses

CODE	C.G. WIDTH (IN)	WIDTH (MM)
EMTR36	36"	910
EMTR42	42"	1070
EMTR48	48"	1220
EMTR54	54"	1380
EMTR60	60"	1530



Post Connectors

CODE	C.G. DESCRIPTION	WIDTH (IN/MM)
EPCT14	Top Post Connector	14"/360
EPCB14	Bottom Post Connector	14"/360
EPCT18	Top Post Connector	18"/460
EPCB18	Bottom Post Connector	18"/460
EBCT21	Top Post Connector	21"/540
EPCB21	Bottom Post Connector	21"/540
EPCT24	Top Post Connector	24"/610
EPCB24	Bottom Post Connector	24"/610

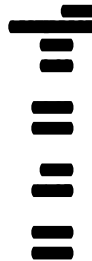

Post Connector Wedge

CODE	C.G.	DESCRIPTION
EPCW8		Bag of 8 Wedges
ETD8		Bag of 8 Stationary Dovetails, 4A & 4B
EMTD8		Bag of 8 Mobile Dovetails, 4A & 4B
ETD32		Bag of 32 Stationary Dovetails, 16A & 16B
EMTD32		Bag of 32 Mobile Dovetails, 16A & 16B



Corner Connectors

CODE	C.G.	DESCRIPTION
ECCL		Left
ECCR		Right



Camtainers®

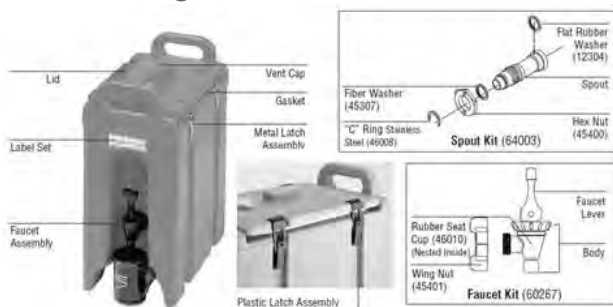

Distributed by
Comcater Pty Ltd
 156 Swann Drive
 Derrimut VIC 3030
 Phone: (03) 8369 4600
 Fax: (03) 8369 4696
www.comcater.com.au



Faucet and Spout

CODE	C.G. THIS PRODUCT	DESCRIPTION	
PART FITS			
60267	All Camtainers (excluding 350LCD)	Faucet Kit: 1-Assembled faucet body w/ Standard style lever, 1-Wing Nut	
64003	All Camtainers (excluding 350LCD)	Spout Kit: 1- Spout sleeve, 1 - Hex nut; 1 - Rubber washer seal (for inside container); 1 - Fiber washer (for outside container); 1- "C" ring (for locking faucet & wing nu to spout assembly)	
12307	All Camtainers (excluding 350LCD)	1- Flat Washer	
45307	All Camtainers (excluding 350LCD)	1-Fiber Washer	
45400A	All Camtainers (excluding 350LCD)	1-Hex Nut	
45401A	All Camtainers (excluding 350LCD)	1-Wing Nut	
46008	All Camtainers (excluding 350LCD)	1-"C" Ring	
46010	All Camtainers (excluding 350LCD)	1-Rubber Seat Cup (46010)	
47219	All Camtainers (excluding 350LCD)	1-Solid Nylon Plug (Converting LCD's to Soup Carrier)	

Gaskets

CODE	C.G. THIS PRODUCT	DESCRIPTION	
PART FITS			
12100	100LCD	1-Gasket	
12101	250LCD, 350LCD, 500LCD	1-Gasket	
12106	1000LCD	1-Gasket	

Label Sets

CODE	C.G. THIS PRODUCT	DESCRIPTION	
PART FITS			
13200	500LCD, 1000LCD	6-Imprinted Beverage Label Set, Large Label	
13201	100LCD, 250LCD,	6-Imprinted Beverage Label Set, Small Label	

Latches

CODE	C.G. THIS PRODUCT	DESCRIPTION	
PART FITS			
60090	100LCD, 1000LCD	Metal Latch Kit: 1-Small 2 Hole Latch, 2-Screws (60315)	
60091	250LCD, 350LCD, 500LCD	Metal Latch Kit: 1-Small 2 Hole Latch, 2-Screws (60314)	
60092	100LCD, 1000LCD	Metal Latch Kit: 1-Small 4 Hole Latch, 4-Screws (60315)	
60093	250LCD, 350LCD, 500LCD	Metal Latch Kit: 1-Small 4 Hole Latch, 4-Screws (60314)	
60264	100LCD, 1000LCD (Units After 01/02)	Plastic Latch Kit : 1-Small 2 Hole Latch, 2-Screws (60315)	
60263	250LCD, 350LCD, 500LCD (Units After 01/02)	Plastic Latch Kit : 1-Small 2 Hole Latch, 2-Screws (60314)	

Lids

CODE	C.G. THIS PRODUCT	DESCRIPTION	
PART FITS			
6316	7 100LCD	1-Lid, 1-Gasket, 1-Vent Pop up Vent Cap (H07001)	
6322	7 250LCD, 350LCD, 500LCD	1-Lid, 1-Gasket, 1-Vent Pop up Vent Cap (H07001)	
6323	7 1000LCD	1-Lid, 1-Gasket, 1-Vent Pop up Vent Cap (H07001)	
7356	8 UC1000	1-Lid, 1-Gasket, 1-Vent Pop up Vent Cap (H07001)	

Vent Caps

CODE	C.G. THIS PRODUCT	DESCRIPTION	
PART FITS			
14200	All Camtainers and Ultra Camtainers	1-Vent Cap (Models before 1-07)	
H07001		1-Black Pop-up Vent	

All Camtainers and
Ultra Camtainers

Plug Kit

CODE	PART FITS C.G. THIS PRODUCT	DESCRIPTION
H14004	All Camtainers and Ultra Camtainers	Camtainer Plug Kit: Plug, Washers, Hex Nuts



Distributed by
Comcater Pty Ltd
156 Swann Drive
Derrimut VIC 3030
Phone: (03) 8369 4600
Fax: (03) 8369 4696
www.comcater.com.au

Camtherm Plate and Pellet Heaters

CODE	PART FITS C.G. THIS PRODUCT	DESCRIPTION
S10013	CHPL100	Blower Motor
S10001	CHPL100	KIT LABEL ASSET MGT 4EA
S10002	CHPL100	KIT PLG TOP SHLF VBR 12EA
S10003	CHPL100	PLUG FOR LID HANDLES 2 EA
S10004	CHPL100	SPRING FOR DISPENSE 1 EA
S10005	CHPL100	LID HANDLE
S10006	CHPL100	CONTROLLER
S10007	CHPL100	ON/OFF SWITCH
S10008	CHPL100	GASKET LID
S10009	CHPL100	CORD/PLUG 6'
S10010	CHPL100	BASKET FOR PLATE/PELLET
S10011	CHPL100	FAN EXHAUST AC AXL 230V
S10012	CHPL100	ELEMENT HEAT 240V/1700W
S10014	CHPL100	PWR RELAY 2POLE 30AMP
S10015	CHPL100	SWITCH RELAY MAN RESET
S10016	CHPL100	FUSE, SLOW BLOW, 2AMP

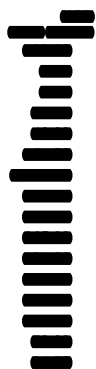



Distributed by
Comcater Pty Ltd
156 Swann Drive
Derrimut VIC 3030
Phone: (03) 8369 4600
Fax: (03) 8369 4696
www.comcater.com.au

Camtherm® Bulk Food Holding Cabinets



COMCATER
- foodservice equipment

Distributed by
Comcater Pty Ltd
156 Swann Drive
Derrimut VIC 3030
Phone: (03) 8369 4600
Fax: (03) 8369 4696
www.comcater.com.au

Axles for 10" Big Wheel

CODE	PART FITS C.G.THIS PRODUCT	DESCRIPTION	
60281	Low profile (CMBH1826LF and LC, CMBHC1826LF and LC) CMBH1826LSP, CMBHC1826LSP	Axle Kit: 1-10" Wheel Axle Long, 2-Lock Nuts (45508)	
60383	Tall profile (CMBH1826TBF and TBC, CMBHC1826TBF and TBC) CMBH1826TSP, CMBHC1826TSP	Axle Kit: 1-10" Wheel Axle Short, 2-Lock Nuts (45508)	
45508	All low profile, tall profile (CMBH1826TBF and TBC, CMBHC1826TBF and TBC)CMBH1826TSP, CMBHC1826TSP	1-Axle Lock Nut	

Casters, 6"

CODE	PART FITS C.G.THIS PRODUCT	DESCRIPTION	
60268	All Camtherm Cabinets (CMBH1826L, CMBHC1826L, CMBH1826T CMBHC1826T,CMBH1826LSP, CMBHC1826LSP, CMBH1826TSP, CMBHC1826TSP)	1-6" Front Caster Swivel w/Brake, 4-Screws (60301)	
60386	Tall profile (CMBH1826TSF and TSC, CMBH1C1826TSF and TSC)	1-6" Rear Caster Rigid, 4-Screws (60301)	

Center Support Bar

CODE	PART FITS C.G.THIS PRODUCT	DESCRIPTION	
7639	16 Tall profile only (CMBH1826TSF and TSC, CMBH1C1826TSF and TSC, CMBH1826TSP and CMBHC1826TSP)	Center Bar Support Kit: 1-Center Bar, 4-Bolts, 4-Washers	
60426	Tall profile only (CMBH1826TSF and TSC, CMBH1C1826TSF and TSC, CMBH1826TSP and CMBHC1826TSP)	Hardware only: 4-Bolts, 4-Washers	

Chassis Plate for 6" Casters

CODE	C.G.PART FITS THIS PRODUCT	DESCRIPTION
45702	All Camtherm Cabinets (CMBH1826L, CMBHC1826L,CMBH1826LSP,CMBHC1826LSP,CMBH1826T,CMBHC1826T,CMBH1826TSP and CMBHC1826TSP)	1-Chassis Plate for 6" Casters



Distributed by
Comcater Pty Ltd
156 Swann Drive
Derrimut VIC 3030
Phone: (03) 8369 4600
Fax: (03) 8369 4696
www.comcater.com.au



Cord Cleat





CODE	PART FITS C.G.THIS PRODUCT	DESCRIPTION
507002	All SP's Camtherm Cabinets (CMBH1826L, CMBHC1826L, CMBH1826T, and CMBHC1826T)	2-Cords Cleat Mounting Screws
60283	Camtherm Cabinets (No SP models) (CMBH1826L, CMBHC1826L)	Cord Cleat Kit for Electric Cord: 1 Cord Cleat, 2-Screws (60324)
60324	Camtherm Cabinets (No SP models)	2-Cord Cleat Mounting Screws

Doors

CODE	PART FITS C.G.THIS PRODUCT	DESCRIPTION
6699C	16 Low profile only (Models before 08/07) (14200) (CMBH1826L, CMBHC1826L,CMBH1826LSP and CMBHCLSP)	Door Kit Celsius: 1-Door, 1-Pivot Pin (42128B), 1-Vent Cap
6699F	16 Low profile only (Models before 08/07) (14200) (CMBH1826L, CMBHC1826L,CMBH1826LSP and CMBHC1826LSP)	Door Kit Fahrenheit: 1-Door, 1-Pivot Pin (42128B), 1-Vent Cap
7699	16 Tall profile only (CMBH1826TSF and TSC, CMBH1C1826TSF and TSC) (Models before 08/07)	Upper Door Kit: 1-Upper Door, 1-Magnetic Gasket Retainer, 3-Hinge Pins, 1-Vent Cap (14200)
7589F	16 Tall profile only (CMBH1826TSF and TSC)(Models before 08/07)	Lower Door Kit Fahrenheit: 1-Upper Door, 1-Magnetic Gasket, 1-Gasket Retainer, 1- Temperature Gauge Fahrenheit, 1-Temp TSC, CMBH1C1826TSFPro Clip Assembly, 3-Hinge Pins, 1-Vent Cap (14200)
7589C	16 Tall profile only (CMBH1826TSF and TSC)(Models before 08/07)	Lower Door Kit Celsius: 1-Upper Door, 1-Magnetic Gasket, 1-Gasket Retainer, 1- Temperature Gauge Celsius, 1-Temp Pro TSC, CMBH1C1826TSFClip Assembly, 3-Hinge Pins, 1-Vent Cap (14200)

Gaskets





CODE	PART FITS C.G.THIS PRODUCT	DESCRIPTION
12134	Low profile only (CMBH1826L, CMBHC1826L,CMBH1826LSP and CMBHC1826LSP)	1-Door Magnetic Gasket
60404	Tall profile only (CMBH1826TSF and TSC, CMBH1C1826TSF, and TSC,CMBH1826TSP and CMBHC1826STP)	1-Upper Door Magnetic Gasket
60405	Tall profile only (CMBH1826TSF and TSC, CMBH1C1826TSF and TSC,CMBH1826TSP and CMBHC1826TSP)	1-Lower Door Magnetic Gasket
45506	All Camtherm Cabinets (CMBH1826L, CMBHC1826L, CMBH1826LSP,CMBHC1826LSP,CMBH1826T,CMBHC1826T,CMBH1826TSP and CMBHC1826TSP)	1-Screw for Door Gasket Retainer
H06015	CMBH1826L, CMBHC1826L, CMBH1826LSP and CMBHC1826LSP	Gasket Retainer Kit: 2-Vertical Retainers, 2-Horizontal Retainers, 16-Screws
43040	Low profile only (CMBH1826L, CMBHC1826L,CMBH1826LSP and CMBHC1826LSP)	1-Door Gasket Interface (requires 16 each screws, 4 each 60414)

60414	All Camtherm Cabinets (CMBH1826L, CMBHC1826L,CMBH1826LSP,CMBHC1826LSP CMBH1826T, CMBHC1826T,CMBH1826TSP and CMBHC1826TSP)	4-Screw for Gasket Interface	
60424	Tall profile only (CMBH1826TSF and TSC, CMBH1C1826TSF and TSC CMBH1826TSP and CMBHC1826TSP)	Lower Door Gasket Retainer Kit: 2-Lower Vertical Retainers, 2-Horizontal Retainers, 16-Screws (45506)	
60377	Tall profile only (CMBH1826TSF and TSC, CMBH1C1826TSF and TSC,CMBH1826TSP and CMBHC1826TSP)	Upper Door Gasket Retainer Kit: 2-Upper Vertical Retainers, 2-Horizontal Retainers, 16-Screws (45506)	
60379	Tall profile only (CMBH1826TSF and TSC, CMBH1C1826TSF and TSC)	Upper Door Interface Gasket Kit: 1-Horizontal Interface, 2-Upper Vertical Interfaces, 1-Center Interface, 20 Screws (5)	
60403	Tall profile only (CMBH1826TSF and TSC, CMBH1C1826TSF and TSC)	Lower Door Interface Gasket Kit: 1-Horizontal Interface, 2-Lower Vertical Interfaces, 1-Center Interface, 20 Screws (5)	







Distributed by
Comcater Pty Ltd
156 Swann Drive
Derrimut VIC 3030
Phone: (03) 8369 4600
Fax: (03) 8369 4696
www.comcater.com.au





Hinges for Doors

CODE	PART FITS C.G.THIS PRODUCT	DESCRIPTION	
42128B	All Camtherm Cabinets (CMBH1826L, CMBHC1826L, CMBH1826T, CMBHC1826T)	1-Aluminum Hinge Pivot Pin	  





Impact Plate for 10" Big Wheel

CODE	PART FITS C.G.THIS PRODUCT	DESCRIPTION	
60282	All low profile, (CMBH1826L, CMBHC1826L)select tall profile (CMBH1826TBF and TBC, CMBHC1826TBF and TBC CMBH1826TSP and CMBHC1826TSP only)	1-Impact Plate Kit for Rear 10" Big Wheel, 4-Bolts (60301)	  





Latch for Door

CODE	PART FITS C.G.THIS PRODUCT	DESCRIPTION	
60135	All Camtherm Cabinets (CMBH1826L, CMBHC1826L, CMBH1826T, CMBHC1826T)	Nylon Latch Kit: 1-Black Nylon Latch, 5-Screws (60311)	  
H07002	Camtherm Cabinets SP models only (CMBH1826L, CMBHC1826L, CMBH1826T, CMBHC1826T)	1-Security Latch Kit	

Louver Panels



CODE	PART FITS C.G.THIS PRODUCT	DESCRIPTION	
43035	Low profile only (CMBH1826L, CMBHC1826L)	1-Louver Panel	 
60407	Tall profile only (CMBH1826TSF and TSC, CMBH1C1826TSF and TSC)	1-Upper Louver Panel	
60406	Tall profile only (CMBH1826TSF and TSC, CMBH1C1826TSF and TSC)	1-Lower Louver Panel	

Menu Clip

CODE	PART FITS C.G.THIS PRODUCT	DESCRIPTION	
MC1	All Camtherm Cabinets	Menu Clip Kit: 1-Menu Clip, 1-Roller, 1-Screw	  

(CMBH1826L,
CMBHC1826L,
CMBH1826T,
CMBHC1826T)

Slide Rails/Uprights





CODE	PART FITS C.G.THIS PRODUCT	DESCRIPTION	
43038	Camtherm Cabinets (No SP models) (CMBH1826L, CMBHC1826L, CMBH1826T, CMBHC1826T)	1-Universal Slide Rail - Chrome	
60286	Camtherm Cabinets (No SP models) (CMBH1826L, CMBHC1826L, CMBH1826T, CMBHC1826T)	1-Aluminum Right Upright, 2-Screws (60331)	
60287	Camtherm Cabinets (No SP models) (CMBH1826L, CMBHC1826L, CMBH1826T, CMBHC1826T)	1-Aluminum Left Upright, 2-Screws (60331)	
H07003	Camtherm Cabinets SP models only	1-Welded 6-Tier Rack Kit: 1-Welded Rack, 4-Spanner Screws, 1-Spanner Driver Bit *For a complete set, you will need to order 2 of H07003 for the left and right uprights.	





Distributed by
Comcater Pty Ltd
156 Swann Drive
Derrimut VIC 3030
Phone: (03) 8369 4600
Fax: (03) 8369 4696
www.comcater.com.au



Temperature Gauge

CODE	PART FITS C.G.THIS PRODUCT	DESCRIPTION	
60202F	All Camtherm Cabinets (CMBH1826L, CMBHC1826L, CMBH1826T, CMBHC1826T)	Fahrenheit Temperature Gauge Kit: 1-Fahrenheit Thermometer, 4-Screws (60310)	
60202C	All Camtherm Cabinets (CMBH1826L,CMBHC1826L, CMBH1826T, CMBHC1826T)	Celsius Temperature Gauge Kit: 1-Celsius Thermometer, 4-Screws (60310)	
60387	All Camtherm Cabinets (CMBH1826L, CMBHC1826L, CMBH1826T, CMBHC1826T) (Units Before 05/03)	Three Wire & Probe Clip Kit: 3-Probe Clip, 3-Wire Clamps, 6-Screws (60323)	
60427	All Camtherm Cabinets (CMBH1826L, CMBHC1826L, CMBH1826T, CMBHC1826T) (Units after 05/03)	Probe Clip Kit: 1-Probe Clip, 1-Screw	

Vent Cap

CODE	PART FITS C.G.THIS PRODUCT	DESCRIPTION	
14200	All Camtherm Cabinets (CMBH1826L, CMBHC1826L, CMBH1826T, CMBHC1826T) (models before 08/07)	1-Vent Cap	
H07001	All Camtherm Cabinets (CMBH1826L, CMBHC1826L, CMBH1826T, CMBHC1826T) (models after 08/07)	1-Black Pop-up Vent	

Wheel, Big 10"

CODE	PART FITS C.G.THIS PRODUCT	DESCRIPTION	
41058	All low profile (CMBH1826L, CMBHC1826L)(select tall profile) (CMBH1826TBF and TBC, CMBHC1826TBF	1-10" Big Rear Wheel	

and TBC
CMBH1826TSP and
CMBHC1826TSP)

 **COMCATER**
- foodservice equipment



Distributed by
Comcater Pty Ltd
156 Swann Drive
Derrimut VIC 3030
Phone: (03) 8369 4600
Fax: (03) 8369 4696
www.comcater.com.au

Camwarmer®

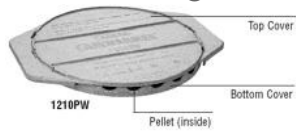

Distributed by
Comcater Pty Ltd
156 Swann Drive
Derrimut VIC 3030
Phone: (03) 8369 4600
Fax: (03) 8369 4696
www.comcater.com.au

Covers

CODE	PART FITS C.G. THIS PRODUCT	DESCRIPTION
6510	1210PW	1-Top Cover
6520	1210PW	1-Bottom Cover



Pellet

CODE	PART FITS C.G. THIS PRODUCT	DESCRIPTION
14524	1210PW	1-Pellet



Combo Cart Plus



foodservice equipment



Distributed by
Comcater Pty Ltd
156 Swann Drive
Derrimut VIC 3030
Phone: (03) 8369 4600
Fax: (03) 8369 4696
www.comcater.com.au

Doors

CODE	PART FITS C.G. THIS PRODUCT	DESCRIPTION	
H13007	All Combo Cart Plus	Kit Door Hinge Pin: 1-Hinge Pin, 2-Metal Retaining Ring	
H13012	All Combo Cart Plus	Kit Door Latch Bolt: 1-Latch Bolt, 1-Spring	
H13013	All Combo Cart Plus	Kit Door Latch Handle: 1-Latch Handle, 1-Screw, 1-Bushing (black)	
S13009	All Combo Cart Plus	Door Menu Panel: 1-Clear Menu Pocket Panel	
H13009	All Combo Cart Plus Electric	Kit Door Cord Keeper: 1-Cord Keeper, 3-Screws	
H13010	All Combo Cart Plus	Kit Door Hinge Bearing: 1-Hinge Bearing, 1-1/2 Shrink Tubing	
H13011	All Combo Cart Plus	Kit Door Hinge Washers: 6-Hinge Spacer Washers (1 ea. 45590,45591,45592,45593,45594,45595)	
C13001	All Combo Cart Plus Non-Electric	Kit Non-Electric Door: 1-Door, 4-Hinge Bearing, 4-1/2 Shrink Tubing, 2-Latch Bolt, 2-Springs, 1-Latch Handle, 1-Screw, 1-Blushing (black), 1-Clear Menu Pocket Panel	
C13002	All Combo Cart Plus Non-Electric	Kit Door No Heater Fahrenheit: 1-Door, 4-Hinge Bearing, 4-1/2" Shrink Tubing, 2-Latch Bolts, 2-Springs, 1-Latch Handle, 1-Screw, 1-Blushing (black), 1-Clear Menu Pocket Panel, 1-Cord Keeper, 3-Screws, 1-Digital Thermometer set F, 1-Thermometer Probe Clamp, 1-SS Screws, 2-SS TEK Screw	
C13003	All Combo Cart Plus Non-Electric	Kit Door No Heater Celsius: 1-Door, 4-Hinge Bearing, 4-1/2" Shrink Tubing, 2-Latch Bolts, 2-Springs, 1-Latch Handle, 1-Screw, 1-Blushing (black), 1-Clear Menu Pocket Panel, 1-Cord Keeper, 3-Screws, 1-Digital Thermometer set c, 1-Thermometer Probe Clamp, 1-SS Screws, 2-SS TEK Screw	

Heaters

CODE	PART FITS C.G. THIS PRODUCT	DESCRIPTION	
H10025	All Combo Cart Plus Electric	Kit Door Heater 110V	
H10024	All Combo Cart Plus Electric	Kit Door Heater 220V	

Power Cords

CODE	PART FITS C.G. THIS PRODUCT	DESCRIPTION	
S07010	All Combo Cart Plus Electric	1-Removable Power Cord, 110V	
S07012	All Combo Cart Plus Electric	1-Removable Power Cord, 220V	
S08047	All Combo Cart Plus Electric (UK Only)	1-Removable Power Cord, 220V	
S13007	All Combo Cart Plus Electric (Japan Only)	1-removable Power Cord, 110V	

Columns/Panels

CODE	PART FITS C.G. THIS PRODUCT	DESCRIPTION	
H13008	All Combo Cart Plus	Kit Column: 1-Stainless Steel Column(panel), 1-Screw	

Rails

CODE	PART FITS C.G. THIS PRODUCT	DESCRIPTION	
CMBPR1	All Combo Cart Plus	1 Pair of Stainless Steel Rails	
CMBPR7	All Combo Cart Plus	7 Pairs of Stainless Steel Rails	

Casters

CODE	PART FITS C.G. THIS PRODUCT	DESCRIPTION	
60033	All Combo Cart Plus	Standard 6"x 1 1/4" Polyurethane, All Swivel with brakes-1ea., w/fasteners	
H10001	All Combo Cart Plus	Heavy Duty 6"x 2" Hi-Modulus Rubber All-Swivel with brakes-1ea., 4-Bolts	

Combo Carts™



COMCATER
Foodservice equipment

Distributed by
Comcater Pty Ltd
156 Swann Drive
Derrimut VIC 3030
Phone: (03) 8369 4600
Fax: (03) 8369 4696
www.comcater.com.au

Axle

CODE	PART FITS C.G.THIS PRODUCT	DESCRIPTION	
60080	CMB1826, CMB1826SP, CMB1826L, CMB1826LSP	1-Axle, 2-Nuts	

Caster

CODE	PART FITS C.G.THIS PRODUCT	DESCRIPTION	
60007	CMB1826, CMB1826SP, CMB1826L, CMB1826LSP	1-Front 5" Swivel Caster w/Brake, 4-Bolts (60300)	

Doors

CODE	PART FITS C.G.THIS PRODUCT	DESCRIPTION	
6683	9 CMB1826, CMB1826L	1-Top Door, 1-Gasket, 1-Vent Cap (14200)	
6684	9 CMB1826	1-Bottom Door, 1-Gasket, 1-Vent Cap (14200)	

Gasket

CODE	PART FITS C.G.THIS PRODUCT	DESCRIPTION	
12124	CMB1826, CMB1826SP, CMB1826L, CMB1826LSP	1-Gasket	

Heat Guard Strip

CODE	PART FITS C.G.THIS PRODUCT	DESCRIPTION	
60070	CMB1826, CMB1826SP, CMB1826L, CMB1826LSP	1-Heat Guard, 6-Screws (60313)	

Hinge for Doors

CODE	PART FITS C.G.THIS PRODUCT	DESCRIPTION	
60064	CMB1826SP, CMB18S6LSP	1-Hinge Welded Pin, 6-Screws	
60066	CMB1826, CMB1826L	Hinge Kit: 1-Stainless Hinge, 6-Screws (60311)	

Impact Plate

CODE	PART FITS C.G.THIS PRODUCT	DESCRIPTION	
44018	CMB1826, CMB1826SP, CMB1826L, CMB1826LSP	1-Impact Plate	

Latches for Doors

CODE	PART FITS C.G.THIS PRODUCT	DESCRIPTION	
H05021	CMB, CMBL (Units After 1/06)	1.6 Plastic Latch Kit: 1-Latch, 4-Screws	
60094		Latch Kit: 1-Four Hole Large Metal Latch, 4-Screws (60314)	

60063	CMB1826, CMB1826L,1826MTC (Units Before 1/06) CMB1826SP	Latch Kit: 1-Welded Bail Latch, 4-Spanner Screws (60322)	█ █ █ █
-------	--	--	------------------

Menu Clip

CODE	PART FITS C.G.THIS PRODUCT	DESCRIPTION	█ █ █ █
MC1	CMB1826, CMB1826SP, CMB1826L, CMB1826LSP	Menu Clip Kit: 1-Clip,1-Roller, 1-Screw	█ █ █ █

Slide Rail

CODE	PART FITS C.G.THIS PRODUCT	DESCRIPTION	█ █ █ █
43009	CMB1826, CMB1826SP, CMB1826L, CMB1826LSP	1-Slide Rail	█ █ █ █

Standard Interior Vertical Support

CODE	PART FITS C.G.THIS PRODUCT	DESCRIPTION	█ █ █ █
60068	CMB1826, CMB1826SP, CMB1826L, CMB1826LSP	1-Standard Interior Vertical Support, 6-Screws (60313)	█ █ █ █

Vent Cap

CODE	PART FITS C.G.THIS PRODUCT	DESCRIPTION	█ █ █ █
14200	CMB1826, CMB1826SP, CMB1826L,CMB1826LSP (models before 1/07)	1-Vent Cap	█ █ █ █
H07001	CMB1826, CMB1826SP, CMB1826L,CMB1826LSP (models after 1/07)	1-Black Pop-up Vent	█

Wheels

CODE	PART FITS C.G.THIS PRODUCT	DESCRIPTION	█ █ █ █
41020	CMB1826, CMB1826SP, CMB1826L, CMB1826LSP	1-Rear 10" Wheel	█ █ █ █

Covered Pitcher

COMCATER
- foodservice equipment



Distributed by
Comcater Pty Ltd
156 Swann Drive
Derrimut VIC 3030
Phone: (03) 8369 4600
Fax: (03) 8369 4696
www.comcater.com.au

Lids

CODE	C.G.	PART FITS THIS PRODUCT	DESCRIPTION
PC64CWLID	26	PC64CW	1-Lid



Dish Caddies - Non-Adjustable



COMCATER
Foodservice equipment



Distributed by
Comcater Pty Ltd
156 Swann Drive
Derrimut VIC 3030
Phone: (03) 8369 4600
Fax: (03) 8369 4696
www.comcater.com.au



Axles

CODE	PART FITS C.G. THIS PRODUCT	DESCRIPTION	
60082	DC1125, DC1225	1-Axle, 2-Nuts	
60083	DC575, DC700, DC825, DC950	1-Axle, 2-Nuts	

Caster Impact Plate

CODE	PART FITS C.G. THIS PRODUCT	DESCRIPTION	
44018	Dish Caddies	1-Impact Plate/Mount Plate	

Casters

CODE	PART FITS C.G. THIS PRODUCT	DESCRIPTION	
60007	DC575, DC700, DC825, DC1225	1-5" Swivel Caster w/Brake, 4-Bolts (60300)	
60008	DC575, DC700, DC825, DC1225	1-5" Swivel Caster, 4-Bolts (60300)	
H06001	DCS950, DCS1125	1-5" Swivel Caster w/Brake, 1-Impact Plate, 4-Screws	

Wheels

CODE	PART FITS C.G. THIS PRODUCT	DESCRIPTION	
41020	Dish Caddies with 10" Wheels and Adjustable Dish Caddies	1-10" Wheel	
H06002	ADCS, DCS950, DCS1125	1-10" Wheel, 1-Nut	

Covers

CODE	PART FITS C.G. THIS PRODUCT	DESCRIPTION	
14300	DC650, DC825, DC950, DC975	1-Vinyl Cover	
14310	DC575, DC700	1-Vinyl Cover	
14311	DCS950, DC1125, DCS1125, DC1225, DC1150,	1-Vinyl Cover	

Dish Caddy - Adjustable



COMCATER
foodservice equipment

Distributed by
Comcater Pty Ltd
 156 Swann Drive
 Derrimut VIC 3030
 Phone: (03) 8369 4600
 Fax: (03) 8369 4696
www.comcater.com.au



Axle Mount Plate

CODE	PART FITS C.G. THIS PRODUCT	DESCRIPTION
44030	ADC4, ADC6	1-Axle Mount Plate



Axles

CODE	PART FITS C.G. THIS PRODUCT	DESCRIPTION
60082	ADC4, ADC6	1-Axle, 2-Nuts
H06014	ADCS	1-Axle, 2-Nuts, 2-Washers
S05001	ADCS	2-Axle Washers



Caster Impact Plate

CODE	PART FITS C.G. THIS PRODUCT	DESCRIPTION
44018	ADC4, ADC6, ADCS	1-Impact Plate/Mount Plate



Casters

CODE	PART FITS C.G. THIS PRODUCT	DESCRIPTION
H06001	ADCS	1-5" Swivel Caster w/Brake, 1-Impact Plate, 4-Screws
60007	All Dish Caddies	1-5" Swivel Caster w/Brake, 4-Bolts (60300)
60008	All Dish Caddies	1-5" Swivel Caster, 4-Bolts (60300)



Wheels

CODE	PART FITS C.G. THIS PRODUCT	DESCRIPTION
41020	Dish Caddies with 10" Wheels and Adjustable Dish Caddies	1-10" Wheel
H06002	ADCS	1-10" Wheel, 1-Nut



Covers

CODE	PART FITS C.G. THIS PRODUCT	DESCRIPTION
ADCC	All Adjustable Dish Caddies	1-Vinyl Cover



Divider Hardware

CODE	PART FITS C.G. THIS PRODUCT	DESCRIPTION
60180	ADC4 & ADC6	1-Washer, 1-Through Hole Knob
45311	ADC4 & ADC6	1-Washer



Towers

CODE	PART FITS C.G. THIS PRODUCT	DESCRIPTION
C05001	ADCS	Tower Kit: 1-Tower, 1-Washer, 1-Knob
H06004	ADCS	1-Washer, 1-Knob



Equipment Stand



COMCATER
Foodservice equipment

Distributed by
Comcater Pty Ltd
 156 Swann Drive
 Derrimut VIC 3030
 Phone: (03) 8369 4600
 Fax: (03) 8369 4696
www.comcater.com.au

Casters

CODE	PART FITS C.G. THIS PRODUCT	DESCRIPTION
60006	Equipment Stand	1-5" Fixed Caster, 4-Bolts (60300)
60007	Equipment Stand	1-5" Swivel Caster w/ Brake, 4-Bolts (60300)
60008	Equipment Stand	1-5" Swivel Caster, 4-Bolts (60300)

Accessories

CODE	PART FITS C.G. THIS PRODUCT	DESCRIPTION
6946	All Equipment Stand Models	1-Tray Rail
60049	All Equipment Stand Models	1-Bracket, 2-Screws
6697	All Equipment Stand Models	Tray Rail Assembly: 1-Rail, 2-Brackets (43008), 2-Screws (60316), 2-Screws (60318)
6945	All Equipment Stand Models	1-Drawer
60278	All Equipment Stand Models	1-Drawer Stop-Flat, 2-Screws (60319)
60279	All Equipment Stand Models	1-Drawer Stop-Angle Body Side, 2-Screws (60319)
43008	All Equipment Stand Models	1 Bracket

Food Bars

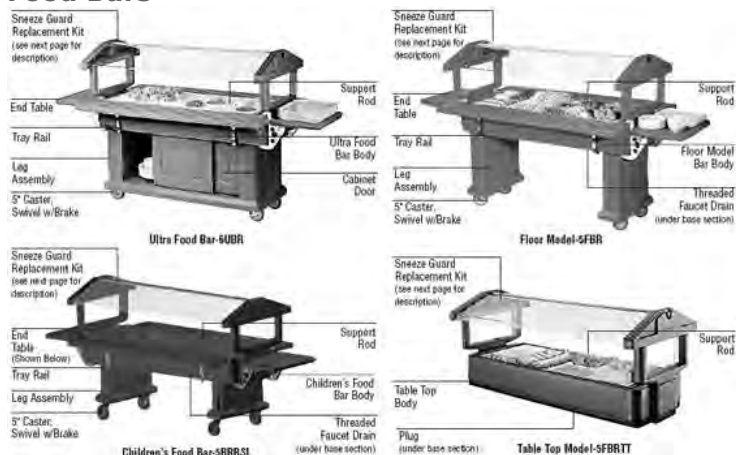

COMCATER
-foodservice equipment-

Distributed by
Comcater Pty Ltd
156 Swann Drive
Derrimut VIC 3030
Phone: (03) 8369 4600
Fax: (03) 8369 4696
www.comcater.com.au

Bodies

CODE	C.G. THIS PRODUCT	PART FITS	DESCRIPTION
6385	5	All 4' Models	1-4 ft. Body
6386	5	All 5' Models	1-5 ft. Body
6975	5	All 6' Models	1-6 ft. Body



Casters

CODE	C.G. THIS PRODUCT	PART FITS	DESCRIPTION
60007	6UBR, 5UBR, 4UBR, UBR72N, UBR60N, UBR48N, 6FBR, 5FBR, 4FBR, FBR72N, FBR60N, FBR48N, 6FBRS, 5FBRS, 4FBRS, FBR72SLN, FBR60SLN, FBR48SLN		1-5" Swivel Caster w/Brake, 4-Bolts (60300)
44018	6UBR, 5UBR, 4UBR, UBR72N, UBR60N, UBR48N, 6FBR, 5FBR, 4FBR, FBR72N, FBR60N, FBR48N		1-5" Caster Impact Plate



Doors

CODE	C.G. THIS PRODUCT	PART FITS	DESCRIPTION
7322	5	4UBR	1-Cabinet Door
7324	5	5UBR, 6UBR	1-Cabinet Door



End Table Hardware

CODE	C.G. THIS PRODUCT	PART FITS	DESCRIPTION
60173		FBRTBL	1-Bracket, 2-Bolts (60302), 2-Washers (60334), 2-Screws (60324)
60368		FBRTBL	4-Fender Washer 1/4" x 1" O.D.
60175		FBRTBL	1-Pivot Bolt Bushing, 1-Pivot Bolt (45123), 1-Pivot Bolt Flat Washer
60174		FBRTBL	1-Thumbscrew, 1-Lock Nut
45123		FBRTBL	1-Pivot Bolt

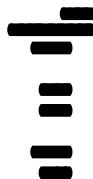

Food Bars Continued

CODE	C.G. THIS PRODUCT	PART FITS	DESCRIPTION
------	-------------------	-----------	-------------



Faucet Drains and Plugs

CODE	C.G. THIS PRODUCT	PART FITS	DESCRIPTION
64005	6UBR, 5UBR, 4UBR, UBR72N, UBR60N, UBR48N, 6FBR, 5FBR, 4FBR, FBR72N, FBR60N, FBR48N, 6FBRS, 5FBRS, 4FBRS, FBR72SLN, FBR60SLN, FBR48SLN		1-Threaded Faucet Drain, 2-"O" Ring (12302), 1-Bushing (46013)
60030	6FBRTT, 5FBRTT, 4FBRTT, FBR72TTN, FBR60TTN, FBR48TTN		1-Plug, 1-Adapter, 1-"O" Ring



Hardware Assembly Kit

PART FITS		
CODE	C.G. THIS PRODUCT	DESCRIPTION
60124	6UBR, 5UBR, 4UBR, 6FBR, 5FBR, 4FBR, 6FBRSL, 5FBRSL, 4FBRSL	1-Hardware Kit
60125	6FBRTT, 5FBRTT, 4FBRTT	1-Hardware Kit



-foodservice equipment



Distributed by
Comcater Pty Ltd
156 Swann Drive
Derrimut VIC 3030
Phone: (03) 8369 4600
Fax: (03) 8369 4696
www.comcater.com.au

Leg/Cabinet Base with Casters and Doors

PART FITS		
CODE	C.G. THIS PRODUCT	DESCRIPTION
7329	5 4UBR, UBR48N	Leg/Cabinet Base, 4-Swivel Casters with Brakes
7330	5 5UBR, 6UBR, UBR60N, UBR72N	Leg/Cabinet Base, 4-Swivel Casters with Brakes
60276	6UBR, 5UBR, 4UBR, 6FBR, 5FBR, 4FBR, 6FBRSL, 5FBRSL, 4FBRSL	1-Leg Mounting Plate, 8-Bolts (60300)
7321	5 4UBR, UBR48N	Leg/Cabinet Base, 4-Swivel Casters with Brakes, 4 Doors
7323	5 5UBR, 6UBR, UBR60N, UBR72N	Leg/Cabinet Base, 4-Swivel Casters with Brakes, 4 Doors

Leg Kits

PART FITS		
CODE	C.G. THIS PRODUCT	DESCRIPTION
7320	5 6FBR, 5FBR, 4FBR, FBR72N, FBR60N, FBR48N	Leg Assembly: 1-Regular Leg, 2-Swivel Casters with Brakes
6383	5 6FBRSL, 5FBRSL, 4FBRSL, FBR72SLN, FBR60SLN, FBR48SLN	Leg Assembly: 1-Short Leg, 2-Swivel Casters with Brakes

Sneeze Guard End Panel

PART FITS		
CODE	C.G. THIS PRODUCT	DESCRIPTION
47243	6UBR, 5UBR, 4UBR, 6FBR, 5FBR, 4FBR, 6FBRTT, 5FBRTT, 4FBRTT, 6FBRSL, 5FBRSL, 4FBRSL	1-End Panel (95/8" x 21")
60304	6UBR, 5UBR, 4UBR, 6FBR, 5FBR, 4FBR, 6FBRTT, 5FBRTT, 4FBRTT, 6FBRSL, 5FBRSL, 4FBRSL	4-Knurled Thumb Bolt

Sneeze Guard Top Panels / Center Bars

PART FITS		
CODE	C.G. THIS PRODUCT	DESCRIPTION
47240	4UBR, 4FBR, 4FBRTT, 4FBRSL	1-Sneeze Guard Panel for 4 ft. Food Bar (159/32" x 461/4")
47241	5UBR, 5FBR, 5FBRTT, 5FBRSL	1-Sneeze Guard Panel for 5 ft. Food Bar (159/32" x 60")
47242	6UBR, 6FBR, 6FBRTT, 6FBRSL	1-Sneeze Guard Panel for 6 ft. Food Bar (159/32" x 675/8")
43018	4UBR, 4FBR, 4FBRTT, 4FBRSL	1-Center Bar with Inserts for 4 ft. Food Bar
43019	5UBR, 5FBR, 5FBRTT, 5FBRSL	1-Center Bar with Inserts for 5 ft. Food Bar
43020	6UBR, 6FBR, 6FBRTT, 6FBRSL	1-Center Bar with Inserts for 6 ft. Food Bar
45234	All Units Includes 4', 5' & 6'	1-Center Bar Thumb Screw (45234)

Sneeze Guard Replacement Kits

PART FITS		
CODE	C.G. THIS PRODUCT	DESCRIPTION
6014	5 4UBR, 4FBR, 4FBRTT, 4FBRSL	2-Sneeze Guard Top Panels, 2-Uprights, 2-Sneeze Guard End Panels, 1-Center Bar, 2-Center Bar Thumb Screws (45234), 2-Hex Bolts (45105), 2-Washers (45302)
6015	5 5UBR, 5FBR, 5FBRTT, 5FBRSL	2-Sneeze Guard Top Panels, 2-Uprights, 2-Sneeze Guard End Panels, 1-Center Bar, 2-Center Bar Thumb Screws (45234), 2-Hex Bolts (45105), 2-Washers (45302)
6016	5 6UBR, 6FBR, 6FBRTT, 6FBRSL	2-Sneeze Guard Top Panels, 2-Uprights, 2-Sneeze Guard End Panels, 1-Center Bar, 2-Center Bar Thumb Screws (45234), 2-Hex Bolts (45105), 2-Washers (45302)

Tension Support Rod

PART FITS		
CODE	C.G. THIS PRODUCT	DESCRIPTION
60188	6UBR, 6FBR, 6FBRSL, 6FBRTT, 5UBR, 5FBR, 5FBRSL, 5FBRT	1-Rod, 2-Flat Head Phillips Screws (60325), 2-Flanged Washers (60342)

Tray Rail Hardware

CODE	C.G. PART FITS THIS PRODUCT	DESCRIPTION
60014	All Food Bars	1-Folding Bracket, 1-Rigid Bracket, 1-Screw (60312), 1-Screw (60327), 2-Bolts (60302), 2-Washers (60334)
60015	All Food Bars	Rigid Bracket Kit: 1-Rigid Bracket, 2-Bolts (60302), 2-Washers (60334)
60290	All Food Bars	Folding Bracket Kit: 1-Folding Bracket, 1-Screw (60312), 1-Screw (60327)
60302	Used in Kits 60014 and 60015	4-Bolts: 1/4-20 x 1 HEX HEAD BOLT
60334	Used in Kits 60014, 60015 and 60173	4-Washers: 1/4 LOCK WASHER



-foodservice equipment



Distributed by
Comcater Pty Ltd
 156 Swann Drive
 Derrimut VIC 3030
 Phone: (03) 8369 4600
 Fax: (03) 8369 4696
www.comcater.com.au

Uprights

CODE	C.G. PART FITS THIS PRODUCT	DESCRIPTION
7319	5 6UBR, 5UBR, 4UBR, 6FBR, 5FBR, 4FBR, 6FBRTT, 5FBRTT, 4FBRTT, 6FBRSL, 5FBRSL, 4FBRSL, 4FBRTT, 6FBRSL, 5FBRSL, 4FBRSL	1-Upright with 1-Attached End Panel Shield
45105	6UBR, 5UBR, 4UBR, 6FBR, 5FBR, 4FBR, 6FBRTT, 5FBRTT, 4FBRTT, 6FBRSL, 5FBRSL, 4FBRSL	1-Hex Head Bolt, 1/4-20 x 5 1/2 for Upright
60335	6UBR, 5UBR, 4UBR, 6FBR, 5FBR, 4FBR, 6FBRTT, 5FBRTT, 4FBRTT, 6FBRSL, 5FBRSL, 4FBRSL	4-Washer 1/4" x 1" O.D.

Front Loading Ultra Pan Carrier® S-Series



foodservice equipment



Distributed by
Comcater Pty Ltd
 156 Swann Drive
 Derrimut VIC 3030
Phone: (03) 8369 4600
Fax: (03) 8369 4696
www.comcater.com.au

Casters

CODE	C.G. THIS PRODUCT	DESCRIPTION
H06006	UPCS400	1-5" Swivel Caster Kit
H06007	UPCS400	1-5" Swivel Caster w/Brake Kit
H06008	UPCS400	1-5" Fixed Caster Kit



Doors

CODE	C.G. THIS PRODUCT	DESCRIPTION
C06002	UPCS400	1-Standard Door, 1-Menu Clip



Hinges for Doors

CODE	C.G. THIS PRODUCT	DESCRIPTION
42128B	UPCS400	1- Aluminum Hinge Pivot Pin (smaller pin)



Latches

CODE	C.G. THIS PRODUCT	DESCRIPTION
H06009	UPCS400	Nylon Latch Kit: 1-9" Nylon Latch, 5-Screws



Menu Clip

CODE	C.G. THIS PRODUCT	DESCRIPTION
H06011	UPCS400	Menu Clip Kit



COMCATER
Foodservice equipment

Distributed by
Comcater Pty Ltd
 156 Swann Drive
 Derrimut VIC 3030
 Phone: (03) 8369 4600
 Fax: (03) 8369 4696
 www.comcater.com.au



H-Series Ultra Pan Carriers and Ultra Camcarts

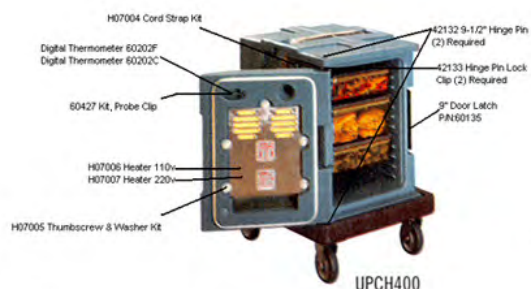

UPCH400

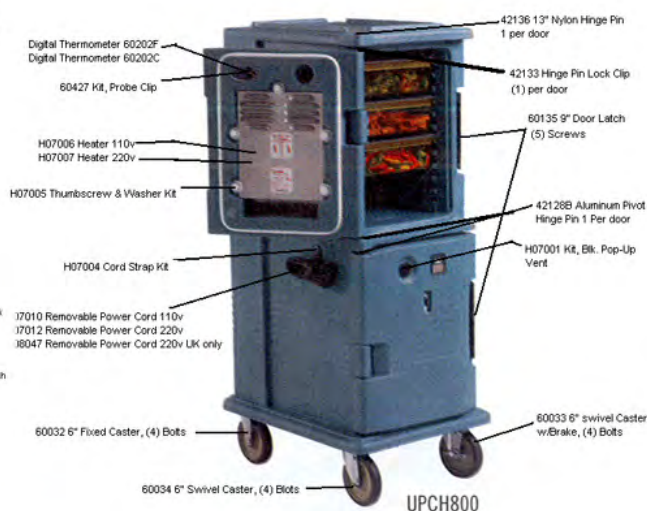

UPCH800

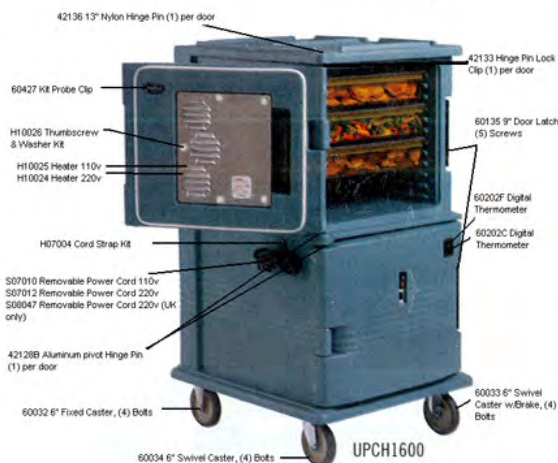

UPCH1600

Casters

CODE	PART FITS C.G. THIS PRODUCT	DESCRIPTION	
60006	UPCHW400	1-5" Fixed Caster, 4-Bolts (60300)	█
60007	UPCHW400	1-5" Swivel Caster w/Brake, 4-Bolts (60300)	█
60008	UPCHW400	1-5" Swivel Caster, 4-Bolts (60300)	█
60032	UPCHW400	Kit Caster 6" Rigid	█
60033	UPCHW400	Kit Caster 6" SWLBK	█
60034	UPCHW400	Kit Caster 6" SWL	█

Doors (not including Heaters)

CODE	PART FITS C.G. THIS PRODUCT	DESCRIPTION	
C10013131	UPCH1600	DOOR ONLY (no heater) for UPCH400 Color: Slate Blue	█
C10013191	UPCH1600	DOOR TOP ONLY (no heater) for UPCH1600 Color: Dark Brown	█
		DOOR TOP ONLY (no heater) for UPCH1600 Color: Granite	█
		Gray	█
C10013192	UPCH1600	DOOR TOP ONLY (no heater) for UPCH1600 Color: Granite	█
		Green	█
C10013401	UPCH1600	DOOR TOP ONLY (no heater) for UPCH1600 Color: Slate Blue	█
C10014131	UPCH1600	BOTTOM DOOR ONLY (no heater) for UPCH1600 Color: Dark	█
		Brown	█
C10014191	UPCH1600,UPCH1600S	BOTTOM DOOR ONLY (no heater) for UPCH1600 Color: Granite	█
		Gray	█
C10014192	UPCH1600,UPCH1600S	BOTTOM DOOR ONLY (no heater) for UPCH1600 Color: Granite	█
		Green	█
C10014401	UPCH1600,UPCH1600S	BOTTOM DOOR ONLY (no heater) for UPCH1600 Color: Slate	█
		Blue	█
C10013110	UPCH1600,UPCH1600S	DOOR TOP ONLY (no heater) for UPCH1600 Color: Black	█
C10014110	UPCH1600,UPCH1600S	BOTTOM DOOR ONLY (no heater) for UPCH1600 Color: Black	█
C12002191	UPCH800,UPCH800SP	DOOR BOTTOM ONLY (no heater) for UPCH800 Color: Granite	█
		Gray	█
C12003191	UPCH800,UPCH800SP	DOOR TOP ONLY (no heater) for UPCH800 Color: Granite Gray	█
C12001110	UPCH400,UPCH400SP	DOOR ONLY (no heater) for UPCH400 Color: Black	█
C12001131	UPCH400,UPCH400SP	DOOR ONLY (no heater) for UPCH400 Color: Dark Brown	█
C12001191	UPCH400,UPCH400SP	DOOR ONLY (no heater) for UPCH400 Color: Granite Gray	█
C12001192	UPCH400,UPCH400SP	DOOR ONLY (no heater) for UPCH400 Color: Granite Green	█
C12001401	UPCH400	DOOR ONLY (no heater) for UPCH400 Color: Slate Blue	█

Doors for Retrofitting Non-Electric into an Electric unit/Replacement Doors with Heater

CODE	PART FITS C.G. THIS PRODUCT	DESCRIPTION	
UPCHD400	UPC400,UPCH400	Heated door w/110V heater	█
UPCHD4002	UPC400,UPCH4002	Heated door w/220V heater	█
UPCHTD800	UPC800,UPCH800	Heated top door w/110V heater	█
UPCHBD800	UPC800,UPCH800	Heated bottom door w/110V heater	█
UPCHTD8002	UPC800,UPCH8002	Heated top door w/220V heater	█
UPCHBD8002	UPC800,UPCH8002	Heated bottom door w/220V heater	█

UPCHTD1600	UPC1600, UPCH1600	Heated top door w/110V heater	
UPCHBD1600	UPC1600, UPCH1600	Heated bottom door w/110V heater	
UPCHTD16002	UPC1600, UPCH16002	Heated top door w/220V heater	
UPCHBD16002	UPC1600, UPCH16002	Heated bottom door w/220V heater	





Distributed by
Comcater Pty Ltd
156 Swann Drive
Derrimut VIC 3030
Phone: (03) 8369 4600
Fax: (03) 8369 4696
www.comcater.com.au



Gasket

CODE	PART FITS C.G. THIS PRODUCT	DESCRIPTION	
12119	UPCH800	1- Gasket	





Hardware Kits

CODE	PART FITS C.G. THIS PRODUCT	DESCRIPTION	
H10026	UPCH1600	Thumbscrew & Washer Kit: 1-Thumbscrew, 1-Washer	
H07005	UPCH400, UPCH4002, UPCHW400, UPCHW4002, UPCH800, UPCH8002, UPCHT800, UPCHT8002	Thumbscrew & Washer Kit: 1-Thumbscrew, 1-Washer	



Casters Hi-Modulus Rubber

CODE	PART FITS C.G. THIS PRODUCT	DESCRIPTION	
H08001	UPCH1600HD, UPCH1600TR/SP	1-6" X 2" Swivel Caster, 4-Bolts, 4-Washers, 4-Nuts	
H08002	UPCH1600HD, UPCH1600TR/SP	1-6" X 2" Swivel Caster w/Brake, 4-Bolts, 4-Washers, 4-Nuts	
H08003	UPCH1600HD, UPCH1600TR/SP	1-6" X 2" Fixed Caster, 4-Bolts, 4-Washers, 4-Nuts	

Casters Polyurethane

CODE	PART FITS C.G. THIS PRODUCT	DESCRIPTION	
60032	UPCH800, UPCH1600	1-6" X 1 1/4" Fixed Caster, w/fasteners(60300)	
60033	UPCH800, UPCH1600	1-6" X 1 1/4" Swivel Caster w/Brake, and fasteners (60300)	
60034	UPCH800, UPCH1600	1-6" X 1 1/4" Swivel Caster, w/fasteners (60300)	
44018	UPCH800	1" Caster Impact Plate for 5" and 6" casters	



Chassis Plate Kits

CODE	PART FITS C.G. THIS PRODUCT	DESCRIPTION	
H08004	UPCH1600, All UPC1600 models (after 3/08)	1-Chassis Plate, 16-Bolts, 16-Washers	



Hinges for Doors

CODE	PART FITS C.G. THIS PRODUCT	DESCRIPTION	
42132	UPCH400	1-9 1/2" Nylon Hinge Pin	
42136	UPCH800	1-13" Nylon Hinge Pin	
42128B	UPCH800, UPCH1600	1- Aluminum Hinge Pivot Pin (smaller pin)	
421133	UPCH400,UPCH800, UPCH1600,UPCH1600HD	1- Pin Lock Clip	





Latches

CODE	PART FITS C.G. THIS PRODUCT	DESCRIPTION	
60135	UPCH400, UPCH800, UPCH1600	1-9" Nylon Latch, 5-Screws (60311) (Includes all Celsius and Fahrenheit Models)	

Locking Hasps

CODE	PART FITS C.G. THIS PRODUCT	DESCRIPTION	
H06013	UPCH400, UPCH400TR/SP, UPCH800, UPCH800TR/SP, UPCH1600, UPCH1600TR/SP	Security Lock Hasp Kit:1 Angled Hasp Plate, 1-Flat Hasp Plate, 9 Spanner Screws, 1-Spanner Drive Bit	

Heaters for Doors

CODE	PART FITS C.G. THIS PRODUCT	DESCRIPTION	
H10025	UPCH1600, UPCH1600TR/SP	1-Heater Unit Only, 110V	
H10024	UPCH1600, UPCH1600TR/SP	1-Heater Unit Only, 220V	
H07006	UPCH400,UPCH400SP UPCHW400,UPCH800, UPCH800SP,UPCHT800	1-Heater Unit Only, 110V	
H07007	UPCH4002, UPCHW4002, UPCH8002, UPCHT8002	1-Heater Unit Only, 220V	

Heater Replacement Parts

CODE	C.G. PART FITS THIS PRODUCT	DESCRIPTION
S13001	Heater models: 47620,47630,47631, 47632	1-Hi-Limited Thermostat
S13002	Heater models: 47620,47631,47632	1-110V Fan
S13003	Heater models: 47630,47631,47632	1-220V Fan
S13004	All door heaters	1-Control Thermostat
S13005	Heater model:47632	1-220V Heater Pad
S08019	Heater model:47631	1-110V Heater Pad
S13006	Heater model:47631	1-110V On/Off switch



foodservice equipment



Distributed by
Comcater Pty Ltd
156 Swann Drive
Derrimut VIC 3030
Phone: (03) 8369 4600
Fax: (03) 8369 4696
www.comcater.com.au

Power Cords

CODE	C.G. PART FITS THIS PRODUCT	DESCRIPTION
S08047	All UPCH 220 Volt Models (UK only)	1-Removable 9 Foot (3 Meters) Power Cord, 220V (UK only)
S13007	All UPCH 110 Volt Models(Japan only)	1-Removable Power Cord, 100V
S07010	All UPCH 110 Volt Models	1-Removable Power Cord, 110V
S07012	All UPCH 220 Volt Models	1-Removable Power Cord, 220V
H07004	Fits all UPCH units	Cord Strap Kit: 1-Cord Strap, 1-Washer, 1-Self-drill Screw, 1-Location Template

Thermometer

CODE	C.G. PART FITS THIS PRODUCT	DESCRIPTION
60202F	All UPCH Units (with digital thermometer)	Digital Fahrenheit Temperature Gauge Kit: 1-Fahrenheit Thermometer, 4-Screws (60310)
60202C	All UPCH Units (with digital thermometer)	Digital Celsius Temperature Gauge Kit: 1-Celsius Thermometer, 4-Screws (60310)
60427	All UPCH models (with digital thermometer)	Kit, Probe clip
S07011	UPCH400 and UPCH800 Models (analog thermometer only)	Analog Thermometer

Temperature Gauges

CODE	C.G. PART FITS THIS PRODUCT	DESCRIPTION
60202F	UPCH1600 Fahrenheit Models	1-Fahrenheit Temperature Gauge unit, 4-Screws (60313)
60202C	UPCH1600 Centigrade Models	1-Centigrade Temperature Gauge unit, 4-Screws (60313)
60203	UPCH1600 Models	2-Wire & Probe Clips w/Screws, 2-Probe Clips, 2-Wire Clamps (14616), 4-Pan Head Screws (60323)
60427	UPCH1600 Models	Probe Clip Kit: 1-Probe Clip, 1-Screw

Strap

CODE	C.G. PART FITS THIS PRODUCT	DESCRIPTION
H07004	All H-Series Models	Cord Strap Kit: 1-Cord Strap, 1-Washer, 1-Self-drill Screw, 1-Location Template

Hand Sink Cart





-foodservice equipment-



Distributed by
Comcater Pty Ltd
156 Swann Drive
Derrimut VIC 3030
Phone: (03) 8369 4600
Fax: (03) 8369 4696
www.comcater.com.au

Doors

CODE	PART FITS C.G. THIS PRODUCT	DESCRIPTION	
60195	KSC402	1-Latch Strike Plate, 4-Screws (60131), 4-Star Washers (60340)	■
46038	KSC402	1-Three Lobe Knob, 1-Sink Top Stud	■
7375	KSC402	Left Door w/Hardware: 1-Left Door, 2-Pivot Pin (42128B), 1-3" Hinge Pin (42238), 1-Pin Lock Clip (42133), 1-Latch Hook (60196), 2-Star Washers (60339), 2-Screws (60321)	■
7376	KSC402	Right Door w/Hardware: 1-Right Door, 2-Pivot Pin (42128B), 1-3" Hinge Pin (42238), 1-Pin Lock Clip (42133), 1-Latch Hook (60196), 2-Star Washers (60339), 2-Screws (60321)	■
60196	KSC402	1-Latch Hook, 2-Screws (60321), 2-Star Washers (60339)	■
42128B	KSC402	1-Aluminum Hinge .Pivot Pin	■
42238	KSC402	1- 3" Hinge Pin	■
42133	KSC402, UPCH1600	1-Pin Lock Clip	■

Towel Holder

CODE	PART FITS C.G. THIS PRODUCT	DESCRIPTION	
47505A	KSC402	1- S.S. Paper Towel Holder	■

Well Cover

CODE	PART FITS C.G. THIS PRODUCT	DESCRIPTION	
S06006	KSC402	1-Knob, 1-Bolt	■

Casters

CODE	PART FITS C.G. THIS PRODUCT	DESCRIPTION	
60032	KSC402	1-Left Side Caster 6" Rigid Type, w/fasteners (60300)	■
60033	KSC402	1-Right Side Caster 6" Swivel w/Brake, and fasteners (60300)	■
44018	KSC402	1-Impact Plate	■

Faucet

CODE	PART FITS C.G. THIS PRODUCT	DESCRIPTION	
47500A	KSC402	1-Stainless Steel	■
47537	KSC402	1-Chrome Faucet ADA Type	■

Gaskets

CODE	PART FITS C.G. THIS PRODUCT	DESCRIPTION	
12131	KSC402	1-Gasket for Cap Assembly	■

Sink

CODE	PART FITS C.G. THIS PRODUCT	DESCRIPTION	
47501	KSC402	1-Stainless Steel Sink 2 Compartment	■
47502	KSC402	1-Drain Basket w/Strainer	■
47400	KSC402	1-Center Outlet Assembly	■
47180	KSC402	1-2" O.D. Worm Type Hose Clamp	■
47503	KSC402	1-Drain, 1-Waste Arm Slip Joint	■
S12004	KSC402	1-32" Drain Flex/Straight Hose Line (Waste Water)	■

Soap Dispenser

CODE	PART FITS C.G. THIS PRODUCT	DESCRIPTION	
60214	KSC402	1-Soap Dispenser, 3-Screws (60323)	■

Tanks

CODE	PART FITS C.G. THIS PRODUCT	DESCRIPTION	
73811	KSC402	1-Fresh Water Tank	■
738225	KSC402	1-Waste Water Tank	■
46036	KSC402	1-Quick Connect Female Coupling (fresh water tank only)	■
47249	KSC402	1-Siphon Tube 3/8" Polytube 24" long (fresh water tank only)	■
60197	KSC402	Cap Kit (both fresh & waste tanks): 1-2" Threaded Cap, 1-Tether Line (47286), 1-Strap Adapter, 1-White Gasket (12131)	■

Water Heater Rack Assembly

PART FITS		
CODE	C.G. THIS PRODUCT	DESCRIPTION
60190	KSC402	Water Heater Kit (110V.)
60193	KSC402	1-Pressure Valve, 1-Three Piece Blow Tube
60191	KSC402	110v. Water Pump Kit
47409	KSC402	1- 1/2" Pipe Threads Street Elbow 90° (Bronze Fitting)
60192	KSC402	1-Electrical Switch/Outlet Box 110v., 4-Pan Head Screws (60323)
47405	KSC402	1-30" Braided Water Connector
47406	KSC402	1-12" Braided Water Connector
60218	KSC402	Hammer Arrester Pressure Chamber Kit: 1-Hammer Arrester Unit, 2-Pipe Nipples (47416), 1-Pipe Tee Fitting (47408), 2-Braided Water Lines (47406), 1-Mount Clip, 1-Pan Head Screw
60225	KSC402	1-Water Supply Hose, 1-Male Quick Disconnect Fitting w/Hose Clamp
47408	KSC402	1-Tee Quest
47416	KSC402	1-Pipe Nipple
47417	KSC402	1-Hammer Arrester
60194	KSC402	1-Pipe Fitting Kit
46037	KSC402	1-Quick-Connect Male 90° (for tank to pump line)
47295	KSC402	1-Wire Tie or Strap
47286	KSC402220	1 Sink Tether Line for Cap Assembly



Distributed by
Comcater Pty Ltd
156 Swann Drive
Derrimut VIC 3030
Phone: (03) 8369 4600
Fax: (03) 8369 4696
www.comcater.com.au

Special Order - International or Overseas Model

PART FITS		
CODE	C.G. THIS PRODUCT	DESCRIPTION
60291	KSC402220	220v. Water Pump Kit: 1-Water Pump 220v. FLOJET, 4-Hex Bolts (60320), 4-Flat Washers S.A.E. (60336)
60211	KSC402220	220v. Electrical Switch Box Kit: 4-Pan Head Screws, 1-Power Cord w/Sealed Plug (47518), 1-Switch Box (47519), 1-Switch Box Cover (47520), 1-Off/On Switch 220v. (47521), 1-Straight Strain Relief (47522), 1-90° Strain Relief (47523)
47530	KSC402220	1-220v. Indicator Light
47521	KSC402220	1-Switch 220v. w/ Indicator Light
47517	KSC402220	1-220v. PRCD Trip Switch - G.F.I.
47410	KSC402220	1-90° Male Elbow for FloJeT pump only 220v.
60266	KSC402220	1-Switch Box, 1-Flip Cover, 1-Gasket, 8-Screws, 1-Switch Plate, 1-Switch 220v On/Off (47521)
47518	KSC402220	1-Power Cord for 220V w/CEE7 Euro Plug
47519	KSC402220	1-J-Box Switch for 220V
47520	KSC402220	1-Switch box Flip Cover for 220V
47522	KSC402220	1-Sink Strain Relief for 220V
47523	KSC402220	1-Sink Strain Relief 90° for 220V
S07001	KSC402220	1-Switch Plate (for inside J-Box & Flip Cover)

Handwash Accessory for Camtainers® and Ultra Camtainers®



Distributed by
Comcater Pty Ltd
 156 Swann Drive
 Derrimut VIC 3030
 Phone: (03) 8369 4600
 Fax: (03) 8369 4696
www.comcater.com.au

Vent Caps

CODE	C.G. THIS PRODUCT	DESCRIPTION	
14200	All Camtainers & Ultra Camtainers (models before 1/07)	1-Vent Cap	
H07001	All Camtainers & Ultra Camtainers (models after 1/07)	1-Black Pop-up Vent Cap	

Dispenser Lever

CODE	C.G. THIS PRODUCT	DESCRIPTION	
LCDES	All Camtainers & Ultra Camtainers	1-Easy Serve Dispenser Lever for Faucet	

Labels

CODE	C.G. THIS PRODUCT	DESCRIPTION	
13227	All Camtainers & Ultra Camtainers	1-Set of 4 Handwash Only Labels	

Paper Towel Holder & Dispenser

CODE	C.G. THIS PRODUCT	DESCRIPTION	
60443	HWATD	1-Black Plastic Paper Towel Dispenser Kit with Screws	
60429	HWAPR	1-Paper Towel Roll Holder Kit with Screws	

Soap Dispenser

CODE	C.G. THIS PRODUCT	DESCRIPTION	
60214	HWAPR, HWATD	1-Soap Dispenser Kit	

Straps

CODE	C.G. THIS PRODUCT	DESCRIPTION	
47176	HWAPR, HWATD (Units Before 01/01/05)	1-Webbed Strap w/Release Buckle	
60479	HWAPR, HWATD (Units After 01/01/05)	Cinch Strap Kit with Screw Washer	

Heat Keepers

Doors

CODE	PART FITS C.G. THIS PRODUCT	DESCRIPTION	
6330	HK93PMC	1-Standard Door, 1-Gasket, 1-Vent Cap	

Hinges for Doors

CODE	PART FITS C.G. THIS PRODUCT	DESCRIPTION	
60012	HK93PMC	Hinge Kit: 1-Stainless Hinge, 3-Screws (60311), 3-Screws (60317)	

Gaskets

CODE	PART FITS C.G. THIS PRODUCT	DESCRIPTION	
12105	HK93PMC	1-Gasket	





-foodservice equipment



Distributed by
Comcater Pty Ltd
 156 Swann Drive
 Derrimut VIC 3030
 Phone: (03) 8369 4600
 Fax: (03) 8369 4696
www.comcater.com.au

High Density Storage System

Rail Kit Set of 2

CODE	PART FITS C.G. THIS PRODUCT	DESCRIPTION	
S09006	CSHDTK10, CSHDTK12, CSHDTK145	4.5' High Density Rail	
S09007	CSHDTK10, CSHDTK12, CSHDTK145	5' High Density Rail	
S09008	CSHDTK10, CSHDTK12, CSHDTK145	6' High Density Rail	

Joiner Kit

CODE	PART FITS C.G. THIS PRODUCT	DESCRIPTION	
H09010	High Density		

End Plate Kit

CODE	PART FITS C.G. THIS PRODUCT	DESCRIPTION	
H09011	High Density		



- foodservice equipment



Distributed by
Comcater Pty Ltd
156 Swann Drive
Derrimut VIC 3030
Phone: (03) 8369 4600
Fax: (03) 8369 4696
www.comcater.com.au

Ice Caddies - Slant Top Ice Caddies and SlidingLid™ Ice Caddies





Distributed by
Comcater Pty Ltd
156 Swann Drive
Derrimut VIC 3030
Phone: (03) 8369 4600
Fax: (03) 8369 4696
www.comcater.com.au



Axles

CODE	PART FITS C.G.THIS PRODUCT	DESCRIPTION	
60079	IC125LB, IC125TB, IC175LB, IC175TB, ICS175TB	1-Axle, 2-Nuts (45410)	■ ■ ■
60288	ICS125LB	1-Axle, 2-Nuts (45410)	■
60083	ICS175LB	1-Axle, 2-Nuts (45410)	■
60289	ICS200TB	1-5/8" Axle, 2-Nuts (45508)	■ ■
45410	IC125LB, IC125TB, IC175LB, IC175TB, ICS175TB, ICS125LB	1-Nut	■
45508	ICS200TB	1-Nut	■

Casters

CODE	PART FITS C.G.THIS PRODUCT	DESCRIPTION	
60006	All ICS models	1-5" Fixed Caster (41022), 4-Bolts (60300)	■ ■ ■ ■
60007	All ICS models	1-5" Swivel w/Brake Caster (41018) 4-Bolts (60300)	■ ■ ■ ■
60008	All ICS models	1-5" Swivel Caster (41021), 4-Bolts (60300)	■ ■ ■ ■
60293	ICS200TB	1-5" Swivel w/Brake Caster, 4-Bolts (60300)	■ ■ ■ ■
60294	ICS200TB	1-5" Swivel Caster, 4-Bolts (60300)	■ ■ ■ ■
60335	All ICS models	4-Washers	■ ■ ■ ■

Drain Shelves

CODE	PART FITS C.G.THIS PRODUCT	DESCRIPTION	
IC125D	All IC125 models	1-Drain Shelf	■ ■
IC175D	All IC175 models	1-Drain Shelf	■ ■
30CWD	All ICS models	1-Drain Shelf	■ ■

Hinge Assembly

CODE	PART FITS C.G.THIS PRODUCT	DESCRIPTION	
60019	All IC125, IC175 models	1-Top Lid Hinge, 6-Screws (60311)	■ ■ ■ ■

Impact Plate

CODE	PART FITS C.G.THIS PRODUCT	DESCRIPTION	
44018	All ICS models	1-Impact Plate	■ ■ ■

Latch

CODE	PART FITS C.G.THIS PRODUCT	DESCRIPTION	
60212	ICS100L	1-4" Nylon Latch, 4-Screws (60311)	■ ■ ■ ■

Lids

CODE	PART FITS C.G.THIS PRODUCT	DESCRIPTION	
6956	22 IC125L, IC125T, IC125LB, IC125TB	1-Large Lid	■ ■ ■ ■
7346	22 IC125L, IC125T, IC125LB, IC125TB (units after 12/94) IC175L, IC175T, IC175LB, IC175TB	1-Small Lid	■
6351	22 ICS100L	Stationary Lid	■
6352	22 ICS100L	Slide Lid	■
7625	22 All ICS125 Models	Stationary Lid	■
7626	22 All ICS125 Models	Slide Lid	■

7634	22	ICS175T/TB, ICS200	Stationary Lid
7635	22	ICS175T/TB, ICS200	Slide Lid
7632	22	ICS175L, ICS175LB	Stationary Lid
7633	22	ICS175L, ICS175LB	Slide Lid



- foodservice equipment



Distributed by
Comcater Pty Ltd
156 Swann Drive
Derrimut VIC 3030
Phone: (03) 8369 4600
Fax: (03) 8369 4696
www.comcater.com.au

Side Latch Assembly

CODE	PART FITS C.G.THIS PRODUCT	DESCRIPTION
60092	All Ice Caddies (Units Before 11/01)	1-Small Metal Latch, 4-Screws (60315)

Threaded Faucet Drains

CODE	PART FITS C.G.THIS PRODUCT	DESCRIPTION
64005	All IC125, IC175 models (Old Style)	1-Threaded Faucet Drain, 1-“O” Ring, Bushing
60296	All ICS models Except ICS100L	1-Ball Valve, Pipe Adapter, Hose adapter, 1-Flat Rubber Washer
60295	ICS100L models only	1-Threaded Faucet (46016), 1-Rubber Washer (12307)
60369	All ICS models	4-Rubber Flat Washers

Thumb Screws

CODE	PART FITS C.G.THIS PRODUCT	DESCRIPTION
45751	All ICS models	1- 1/4 x 30 Knob

Wheels

CODE	PART FITS C.G.THIS PRODUCT	DESCRIPTION
41019	IC125LB, IC125TB, ICS125LB	1-8" Wheel
41020	IC175LB, IC175TB, ICS175LB, ICS175TB	1-10" Wheel
41058	ICS200TB only (Donut)	1-10" Aluminum Hub Wheel

Note: Replacement parts for all IC models will be available until December 31, 2007.

Note: Replacement parts for all IC models will be available until December 31, 2007.

Ingredient Bins

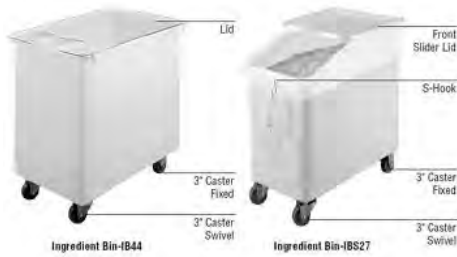





COMCATER
Foodservice equipment









Distributed by
Comcater Pty Ltd
156 Swann Drive
Derrimut VIC 3030
Phone: (03) 8369 4600
Fax: (03) 8369 4696
www.comcater.com.au

Note: Replacement parts for all IC models will be available until December 31, 2007.

Casters

CODE	PART FITS C.G. THIS PRODUCT	DESCRIPTION	
60431	IBS20 IBS27 (Units After 01/21/05)	1-Front 3" Swivel Caster, 4-Screws (45516)	
60430	IBS20 IBS27 (Units After 01/21/05)	1-Front 3" Fixed Caster, 4-Screws (45516)	
60005	IBS37, IB27, IB32, IB36, IB44, IBS27 (Units Before 01/21/05)	1-Front 3" Swivel Caster, 4-Bolts (60303)	
60009	IBS37, IB27, IB32, IB36, IB44, IBS27 (Units Before 01/21/05)	1-Rear 3" Fixed Caster, 4-Bolts (60303)	

Lids

CODE	PART FITS C.G. THIS PRODUCT	DESCRIPTION	
IB27LIDCV26	IB27	1-Lid	
IB32LIDCV26	IB32	1-Lid	
IB36LIDCV26	IB36	1-Lid	
IB44LIDCV26	IB44	1-Lid	
60432	IBS20, IBSF27	1-Front Slider Lid	
60433	IBS20, IBSF27	1-Back Lid	
60270	IBS27	1-Back Lid	
60271	IBS27	1-Front Slider Lid	
60272	IBS37	1-Back Lid	
60273	IBS37	1-Front Slider Lid	

S-Hook

CODE	PART FITS C.G. THIS PRODUCT	DESCRIPTION	
45423	IBS20, IBS27, IBS37	1-S Hook	

Insulated Bakery Containers



Bakery Insulated Container



Distributed by
Comcater Pty Ltd
156 Swann Drive
Derrimut VIC 3030
Phone: (03) 8369 4600
Fax: (03) 8369 4696
www.comcater.com.au



Doors

CODE	PART FITS C.G. THIS PRODUCT	DESCRIPTION	
7398	BK60406, BK60407	1-Standard Door, 1-Gasket, 1-Vent Cap	

Gaskets

CODE	PART FITS C.G. THIS PRODUCT	DESCRIPTION	
12133	BK60406, BK60407	1-Gasket	

Hinges for Doors

CODE	PART FITS C.G. THIS PRODUCT	DESCRIPTION	
42128B	BK60406, BK60407	1- Aluminum Hinge Pivot Pin (smaller pin)	



Latches

CODE	PART FITS C.G. THIS PRODUCT	DESCRIPTION	
60135	BK60406, BK60407	1-9" Nylon Latch, 5-Screws (60311) (Includes all Celsius and Fahrenheit Models)	

Retainer Bar

CODE	PART FITS C.G. THIS PRODUCT	DESCRIPTION	
60367	BK60406, BK60407	1-Retainer Bar, 1-Stainless Screw	

Vent Cap

CODE	PART FITS C.G. THIS PRODUCT	DESCRIPTION	
14200	All Bakery Carts (models before 1/07)	1-Vent Cap	
H07001	All Bakery Carts (models before 1/07)	1-Black Pop-up Vent	

Insulated Front Loading Camcarriers®



Distributed by
Comcater Pty Ltd
 156 Swann Drive
 Derrimut VIC 3030
 Phone: (03) 8369 4600
 Fax: (03) 8369 4696
www.comcater.com.au

Casters

CODE	PART FITS C.G. THIS PRODUCT	DESCRIPTION
60006	600MPC	1-5" Fixed Caster, 4-Bolts (60300)
60007	600MPC	1-5" Swivel Caster w/Brake, 4-Bolts (60300)

Doors

CODE	PART FITS C.G. THIS PRODUCT	DESCRIPTION
6318	300MPC, 1318MTC, 150MPC	1-Standard Door, 1-Gasket, 1-Vent Cap
7341	800MPC	1-Top Standard Door, 1-13" Hinge Pin, 1-Pin, 1-Clip, 1-Bushing, 1-Gasket, 1-Vent Cap
7342	800MPC	1-Bottom Standard Door, 1-13" Hinge Pin, 1-Pin, 1-Clip, 1-Bushing, 1-Gasket, 1-Vent Cap
6341	200MPC	1-Standard Door, 1-Gasket, 1-Vent Cap

Gaskets

CODE	PART FITS C.G. THIS PRODUCT	DESCRIPTION
12102	300MPC, 1318MTC	1-Gasket
12109	200MPC	1-Gasket

Hinges for Doors

CODE	PART FITS C.G. THIS PRODUCT	DESCRIPTION
60012	300MPC, 1318MTC, 200MPC	Hinge Kit: 1-Stainless Hinge, 3-Screws (60311), 3-Screws (60317)

Latches

CODE	PART FITS C.G. THIS PRODUCT	DESCRIPTION
60090	All Camcarriers	Metal Latch Kit: 1-Metal Latch, 1-Small 2 Hole Latch, 2-Screws (60315) Note: Mount plate has 6 holes, but is designed for 2-hole application.
60092	All Camcarriers	Metal Latch Kit: 1 Metal Latch, 1-Small 4 Hole Latch, 4-Screws (60315)
H05021	300MPC, 1318MTC	1.6 Plastic Latch Kit: 1-Latch, 4 Screws
60264	300MPC	1.1 Small Plastic 2 Hole Latch
60094	300MPC	Latch Kit: 1 Large Metal 4 Hole Latch, 4-Screws (60315)

Vent Cap

CODE	PART FITS C.G. THIS PRODUCT	DESCRIPTION
14200	All Camcarriers	1-Vent Cap
H07001	All Camcarriers	1-Black Pop-up Vent

Insulated Front Loading Ultra Pan Carrier®



foodservice equipment



Distributed by
Comcater Pty Ltd
156 Swann Drive
Derrimut VIC 3030
Phone: (03) 8369 4600
Fax: (03) 8369 4696
www.comcater.com.au

Casters

CODE	PART FITS C.G. THIS PRODUCT	DESCRIPTION
60006	600MPC	1-5" Fixed Caster, 4-Bolts (60300)
60007	UPCW400, UPCW4004S	1-5" Swivel Caster w/Brake, 4-Bolts (60300)
60008	UPCW400, UPCW4004S	1-5" Swivel Caster, 4-Bolts (60300)

Gaskets

CODE	PART FITS C.G. THIS PRODUCT	DESCRIPTION
12119	UPC400	1-Gasket

Doors

CODE	PART FITS C.G. THIS PRODUCT	DESCRIPTION
7335	UPC400	1-Standard Door, 2-Pins, 2-Clips, 2-Bushings, 1-Gasket, 1-Vent Cap

Hinges for Doors

CODE	PART FITS C.G. THIS PRODUCT	DESCRIPTION
42132	UPC400	1-9 1/2" Nylon Hinge Pin
42133	UPC400	1-Hinge Pin Lock Clip

Latches

CODE	PART FITS C.G. THIS PRODUCT	DESCRIPTION
60094	All Ultra Pan Carriers	Latch Kit: 1-Large Metal 4 Hole Latch, 4-Screws (60315)
60135	UPC400	1-9" Nylon Latch, 5-Screws (60311) (Includes all Celsius and Fahrenheit Models)
60264	All Ultra Carriers (Units After 01/02)	1-Small Plastic Latch 2 Hole, 2-Screws (60315)
H06013	UPC400	Security Lock Hasp Kit: 1-Angled Hasp Plate, 1-Flat Hasp Plate, 9-Spanner Screws, 1-Spanner Drive Bit

Vent Cap

CODE	PART FITS C.G. THIS PRODUCT	DESCRIPTION
14200	All Ultra Pan Carriers	1-Vent Cap
H07001	All Ultra Pan Carriers	1-Black Pop-up Vent

Temperature Gauge

CODE	PART FITS C.G. THIS PRODUCT	DESCRIPTION
60202F	UPC400F, UPC600F, UPC800F, UPC1200F, UPC1600F	Fahrenheit Temperature Gauge Kit: 1-Fahrenheit Thermometer, 4-Screws (60313)
60202C	UPC400C, UPC600C, UPC800C, UPC1200C, UPC1600C	Centigrade Temperature Gauge Kit: 1-Centigrade Thermometer, 4-Screws (60313)
60203	UPC400F, UPC600F, UPC800F, UPC1200F, UPC1600F, UPC400C, UPC600C, UPC800C, UPC1200C, UPC1600C	Two Wire & Probe Clip Kit: 2-Probe Clips, 2-Wire Clamps, 4-Pan Head Screws (60323)

Thermometer Gauge available until December 31, 2011 or until supplies are depleted, whichever occurs first.

KD Service Carts



COMCATER
foodservice equipment

Distributed by
Comcater Pty Ltd
 156 Swann Drive
 Derrimut VIC 3030
 Phone: (03) 8369 4600
 Fax: (03) 8369 4696
www.comcater.com.au







Thermometer Gauge available until December 31, 2011 or until supplies are depleted, whichever occurs first.



Casters

CODE	PART FITS C.G. THIS PRODUCT	DESCRIPTION	
41063	KD Service Cart BC331KD, BC331KD	1-4" Swivel Caster (Bolts Not Required) Stem Caster	

Handles







CODE	PART FITS C.G. THIS PRODUCT	DESCRIPTION	
41079	KD Service Cart BC340KD	1-Handle (Black)	
41080	KD Service Cart BC340KD	1-Handle (Speckled Gray)	
41065	KD Service Cart BC331KD480	1-Handle (Speckled Gray)	
41066	KD Service Cart BC331KD110	1-Handle (Black)	

Plugs



CODE	PART FITS C.G. THIS PRODUCT	DESCRIPTION	
41067	KD Service Cart BC331KD480	1- Set of 2 Handle Plugs (Speckled Gray)	
41068	KD Service Cart BC331KD110	1- Set of 2 Handle Plugs (Black)	

Note: Casters not interchangeable.

Shelves

CODE	PART FITS C.G. THIS PRODUCT	DESCRIPTION	
41101110	KD Service Cart BC331KD110	KD Top Shelf SM- (Black)	
41101480	KD Service Cart BC331KD480	KD Top Shelf SM- (Speckled Gray)	
41102110	KD Service Cart BC331KD110	KD Bottom Shelf SM- (Black)	
41102480	KD Service Cart BC331KD480	KD Bottom Shelf SM- (Speckled Gray)	
41105110	KD Service Cart BC331KD110	KD Mid Shelf SM/No Tube (Black)	
41105480	KD Service Cart BC331KD480	KD Mid Shelf SM/No Tube (Speckled Gray)	
41107110	KD Service Cart BC331KD110	KD Mid Shelf SM W/Tubes (Black)	
41107480	KD Service Cart BC331KD480	KD Mid Shelf SM W/Tubes (Speckled Gray)	
41110000	KD Service Carts	KD SM Cart Alum Posts	

Accessories

CODE	PART FITS C.G. THIS PRODUCT	DESCRIPTION	
BC331KDSH110	KD Service Carts	KD Service Cart Silverware Holder	
BC331KDTCT110	KD Service Carts	KD Service Cart Trash Container	

KD Utility Carts



- foodservice equipment



Distributed by
Comcater Pty Ltd
 156 Swann Drive
 Derrimut VIC 3030
Phone: (03) 8369 4600
Fax: (03) 8369 4696
www.comcater.com.au

Casters

CODE	PART FITS C.G. THIS PRODUCT	DESCRIPTION
41076	KD Utility Cart BC340KD	1-5" Swivel caster (Bolts Not Required) Stem Caster
BC340KDCSB000	KD Utility Cart BC340KD	LG KD Cart Swivel caster w/brake

Handles

CODE	PART FITS C.G. THIS PRODUCT	DESCRIPTION
41079	KD Utility Cart BC340KD110	1-Handle (Black)
41080	KD Utility Cart BC340KD480	1-Handle (Speckled Gray)

Plugs

CODE	PART FITS C.G. THIS PRODUCT	DESCRIPTION
41078	KD Utility Cart BC340KD480	1-Set of 2 Handle Plugs (Speckled Gray)
41077	KD Utility Cart BC340KD110	1-Set of 2 Handle Plugs (Black)

Shelves

CODE	PART FITS C.G. THIS PRODUCT	DESCRIPTION
41103110	KD Utility Cart BC340KD110	KD Top Shelf LG- (Black)
41103480	KD Utility Cart BC340KD480	KD Top Shelf LG- (Speckled Gray)
41104110	KD Utility Cart BC340KD110	KD Bottom Shelf LG- (Black)
41104480	KD Utility Cart BC340KD480	KD Bottom Shelf LG- (Speckled Gray)
41106110	KD Utility Cart BC340KD110	KD Mid Shelf LG/No Tube (Black)
41106480	KD Utility Cart BC340KD480	KD Mid Shelf LG/No Tube (Speckled Gray)
41108110	KD Utility Cart BC340KD110	KD Mid Shelf W/Tubes (Black)
41108480	KD Utility Cart BC340KD480	KD Mid Shelf LG W/Tubes (Speckled Gray)
41109000	KD Utility Carts	KD LG Cart Alum Posts

Panels

CODE	PART FITS C.G. THIS PRODUCT	DESCRIPTION
BC340KDP110	KD Utility Cart BC340KD110	Bus Cart KD Panel Set (Black)
BC340KDP480	KD Utility Cart BC340KD480	Bus Cart KD Panel Set (Speckled Gray)

Meal Delivery Carts



foodservice equipment



Distributed by
Comcater Pty Ltd
156 Swann Drive
Derrimut VIC 3030
Phone: (03) 8369 4600
Fax: (03) 8369 4696
www.comcater.com.au

Kit Louvered Panel

CODE	C.G. THIS PRODUCT	DESCRIPTION
H13015	MDC1520S20 (after 5/18/13) MDC1520S10, MDC1520S10HD, MDC1520T16 (after 11/24/14) MDC1418S20 (after 11/13) MDC1418T16 (after 6/23/14)	1 - louvered vent panel 4- Screws (44678), 4- Washers (45302)

Axles

CODE	C.G. THIS PRODUCT	DESCRIPTION
60129	MDC1520S20 (prior to 5/18/13)	1-Stainless Steel Axle, 2-Stainless Steel Locking Nuts (45415), 2-Stainless Steel Flat Washer (60341)
45415	MDC1520S20 (prior to 5/18/13)	1-Nylock Nut

Casters

CODE	C.G. THIS PRODUCT	DESCRIPTION
H13017	MDC1520S20,(after 5/18/13) MDC1520S10, MDC1520S10HD, MDC1418S20	1 - 6" x 2" HD stainless steel caster swivel with brake 4-Stainless Steel Hex Bolts (45329), 4-Stainless Steel Flat Washers (45330)
H13018	MDC1520S20, (after 5/18/13) MDC1520S10, MDC1520S10HD, MDC1418S20	1 - 6" x 2" HD stainless steel caster rigid, 4-Stainless Steel Hex Bolts (45329), 4-Stainless Steel Flat Washers (45330)
60128	MDC1520S20 (prior to 5/18/13)	1-5" Stainless Steel Swivel Caster w/Brake, 4-Stainless Steel Bolts (60307)
60139	MDC1520T16 (formerly MDC16B) MDC1418T16 (formerly MDC16A)	1-6" Swivel w/Brake Stainless Steel Caster, 4-Stainless Steel Bolts (60308)
60170	MDC1520T16 (formerly MDC16B) MDC1418T16 (formerly MDC16A)	1-6" Fixed Stainless Steel Caster, 4-Stainless Steel Bolts (60308)
60417	MDC1418S20, MDC1520S10	1-5" Rigid Stainless Steel Caster, 4-Stainless Steel Carriage Bolts, 4-Stainless Steel Washers, 4-Nylock Stainless Steel Hexnuts
60418	MDC1418S20, MDC1520S10	1-5" Swivel w/ Brake Stainless Steel Caster, 4-Stainless Steel Carriage Bolts, 4-Stainless Steel Washers, 4-Nylock Stainless Steel Hexnuts
60388	MDC1520T30, MDC1418T30, MDC1520S20 (after 5/18/13)	1-6" Swivel w/Brake Stainless Steel Caster, 4-Stainless Steel Carriage Bolts, 4-Stainless Steel Washers, 4-Nylock Stainless Steel Hexnuts
60389	MDC1520T30, MDC1418T30, MDC1520S20 (after 5/18/13)	1-6" Rigid Stainless Steel Caster, 4-Stainless Steel Carriage Bolts, 4-Stainless Steel Washers, 4-Nylock Stainless Steel Hexnuts
60425	MDC1418S20, MDC1520T30, MDC1418T30, MDC1520S20 (after 5/18/13)	4-Stainless Steel Carriage Bolts, 4-Stainless Steel Washers, 4-Nylock Stainless Steel Hexnuts
60442	MDC1411T60	4 - Bolts for Casters
H08002	MDC1411T60	1-6" X 2" Swivel Caster w/Brake, 4-Bolts, 4-Washers, 4-Nuts
H08003	MDC1411T60	1-6" X 2" Fixed Caster, 4-Bolts, 4-Washers, 4-Nuts
H14005	MDC1418S20, MDC1520S20, MDC1520S10, MDC1520S10HD, MDC1418T30, MDC1520T30	1- 6" X 2" Swivel Caster w/Brake, 4-Stainless Steel Carriage Bolts(45455), 4- Stainless Steel Flat Washer (45330), 4-Nylock Stainless Steel Hexnuts(45456)
H14006	MDC1418S20, MDC1520S20, MDC1520S10, MDC1520S10HD, MDC1418T30, MDC1520T30	1- 6" X 2" Rigid Stainless Steel Caster, 4-Stainless Steel Carriage Bolts (45455), 4-Stainless Steel Flat Washer (45330), 4-Nylock Stainless Steel Hexnuts(45456)

Caster Impact Plates

CODE	C.G. THIS PRODUCT	DESCRIPTION
44037	MDC1520S20 (formerly MDC1520) (Before 5/18/13)	1-Stainless Steel Impact Plate for Axle

44041	MDC1520S20 (formerly MDC1520) (Before 5/18/13)	1-Tee Shaped Impact Plate for Swivel Casters	
-------	--	--	--



-Foodservice equipment-



Distributed by
Comcater Pty Ltd
156 Swann Drive
Derrimut VIC 3030
Phone: (03) 8369 4600
Fax: (03) 8369 4696
www.comcater.com.au

Chassis Plates

CODE	C.G. THIS PRODUCT	PART FITS	DESCRIPTION
60398	MCD1520T30, MDC1418T30, MDC1418S20 MDC1520S20 (after 5/13/13)		Chassis Plate Kit: 1- Chassis Plate, 12 -Bolts (45329), 12-Flat Washers (45330)
60415	MCD1520T30, MDC1418T30, MDC1411T60, MDC1418S20, MDC1520S20 (after 5/18/13)		Chassis Hardware Kit: 12-Bolts (45329), 12-Flat Washers (45330)
45702	MDCT16, MDC24, MDC24F		1 - Chassis Plate

Doors

CODE	C.G. THIS PRODUCT	PART FITS	DESCRIPTION
H13002	LEFT DOOR KIT for MDC1520S20 (units after Aug 3, 2012)		Door Kit: 1- Left ABS Door, 1-Menu Clip, 1-Menu clip roller, 1-Thumbscrew, 1-Nylon wing nut, 1-latch hook, 2-point screw, 2-star lock washer
H13003	RIGHT DOOR KIT for MDC1520S20 (units after Aug 3, 2012)		Door Kit: 1- Right ABS Door, 1-Menu Clip, 1-Menu clip roller, 1-Thumbscrew, 1-Nylon wing nut, 1-latch hook, 2-point screw, 2-star lock washer
H13005	LEFT DOOR KIT for MDC1418S20 (units after Aug 3, 2012)		1-Left Door, 3-Hinge Pivot Pin, 1-Menu Clip
H13006	RIGHT DOOR KIT for MDC1418S20 (units after Aug 3, 2012)		1-Right Door, 3-Hinge Pivot Pin, 1-Menu Clip
H13014	Door Kit for MDC1520S10, MDC1520S10HD		Door Kit- ABS Door, 1- Hinge Pivot Pin (42128B)
6376	24 MDC1520S20 (formerly MDC1520) (Units After 04/03/00)		1-Right Door, 3-Hinge Pivot Pin, 1-Menu Clip
6375	24 MDC1520S20 (formerly MDC1520)		1-Left Door, 3-Hinge Pivot Pin, 1-Menu Clip (before 8/3/12)
60178	MDC1418T16 (formerly MDC16A)		Door Kit: 1-Gray Door, 1-Latch, 1-Latch Cover, 1-Nylon Hinge Pivot Pin, 1-Top Hinge Pin, 1-Hinge Pin Lock Clip, 4-Wing Nuts
60179	MDC1418T16 (formerly MDC16A)		Door Kit: 1-Brown Door, 1-Latch, 1-Latch Cover, 1-Hinge Pivot Pin, 1-Top Hinge Pin, 1-Hinge Pin Lock Clip, 4-Wing Nuts
60176	MDC1520T16 (formerly MDC16B)		Door Kit: 1-Gray Door, 1-Latch, 1-Latch Cover, 1-Hinge Pivot Pin, 1-Top Hinge Pin, 1-Hinge Pin Lock Clip, 4-Wing Nuts
60392	MDC1520T30, MDC1418T30 (Units Before 03/01/05)		1-Right Door Kit
60393	MDC1520T30, MDC1418T30 (Units Before 03/01/05)		1-Left or Middle Door Kit
60394	MDC1520T30, MDC1418T30 (Units Before 03/01/05)		1-Door Handle Kit
60480	MDC1411T60 (Units After 03/01/05)		1-Door Lock Block Kit
47255	MDC1520T16, MDC1418T16		1-Tack Bumper
H05002	MDC1520T30, MDC1418T30 (Units After 03/01/05)		1-Right Door Kit
H05001	MDC1520T30, MDC1418T30 (Units After 03/01/05)		1-Left or Middle Door Kit
7700	24 MDC1418S20 (Units before 8/3/12)		Left Door Kit: 1-Door, 3-Hinge Pivot Pins, 1-Menu Clip (MC1)
7701	24 MDC1418S20 (Units before 8/3/12)		Right Door Kit: 1-Door, 3-Hinge Pivot Pins, 1-Menu Clip (MC1)
60438	MDC1411T60		1-Left or Middle Door Kit (No Menu Clip)
60439	MDC1411T60		1-Right Door Kit (No Menu Clip)

Handles

CODE	C.G. THIS PRODUCT	PART FITS	DESCRIPTION
60390	MDC1418T30, MDC1520T30		1-Side Handle Kit (body mounted)
60394	MDC1418T30, MDC1520T30 (Units Before 03/01/05)		1-Door Handle Kit
60437	MDC1411T60		1-Door Handle Kit

Hinges

CODE	C.G. THIS PRODUCT	PART FITS	DESCRIPTION
H13016			1- Top Hinge Pin, 1-Stainless Steel Retaining



Distributed by
Comcater Pty Ltd
156 Swann Drive
Derrimut VIC 3030
Phone: (03) 8369 4600
Fax: (03) 8369 4696
www.comcater.com.au



42128B	Kit Hinge Pin MDC1520S10, MDC1520S10HD MDC1520S20 (formerly MDC1520), MDC1418S20, MDC1418T16, (formerly MDC16A), MDC1520T16 (formerly MDC16B), MDC1418T30, MDC1520T30, MDC1411T60	1-Aluminum Hinged Pivot Pin	█
47250	MDC1520S20 (formerly MDC1520), MDC1520T30, MDC1418T30, MDC1418S20	1-Nylon Hinge Spacer	█
60440	MDC1411T60	1-Pivot Pin Lock Kit (Units Before 01/05)	█
42238	MDC1520S20 (formerly MDC1520), MDC1418T16, MDC1520T16	1-New Style Top Hinge Pin (Aluminum Pin) (Units Between 04/19/96 - 04/03/00)	█
42133	MDC1520S20 (formerly MDC1520), MDC1418T16, MDC1520T16	1-New Style Top Hinge Pin Lock Clip (Units Between 04/19/96 - 04/03/00)	█

Latches

CODE	PART FITS C.G. THIS PRODUCT	DESCRIPTION	█
H05003	MDC1520T30, MDC1418T30 (Units After 03/01/05)	1-Security Latch Strike Plate Kit	█
60419	MDC1418S20 (Units before 8/3/12)	1-Security Latch Kit for Door Mount: 1-Latch Plate, 2-Screws	█
60131	MDC1520S20 (before 8/3/12) (formerly MDC1520) MDC1418S20	Nylon Latch Kit: 1-Nylon Latch, 1-Strike Plate, 6-Screws (60311)	█
H13004	Latch Door Plate Kit MDC1520S20,(units after 8/3/12)	Kit Latch strike plate kit w/fasteners	█
60196	MDC1418S20, MDC1520S20, MDC1418T30, MDC1520T30, MDC1411T60	Latch Hook 2ea.#10 x 1/2 A Type Screws(45202)	█
60171	MDC1520T16 (formerly MDC16B), MDC1418T16 (formerly MDC16A)	1-Latch, 4-Nylon Nuts (60344), 1 Latch Cover	█
14606	MDC1520T16 (formerly MDC16B), MDC1418T16 (formerly MDC16A)	1-Latch Cover (Attaches to Door)	█
60172	MDC1520T16, (formerly MDC16B), MDC1418T16 (formerly MDC16A)	1-Strike Plate, 2-Screws (60311) (Attaches to Body)	█
60395	MDC1418T30, MDC1520T30	1-Nylon Internal Latch Kit	█
60396	MDC1520T30, MDC1418T30	Security Latch Kit for Door Mount: 1-Slide, 1-Base Plate, 2-Carriage Bolts, 2-Knurled Plastic Knobs (45337), 2-Flat Washers (Units Before 03/01/05)	█
60397	MDC1520T30, MDC1418T30	Latch Strike Plate Kit: 1-Strike Plate, 3-Bolts (45204)	█
60419	MDC1418S20 (Units before 8/3/12)	Security Latch Kit for Door Mount: 1-Latch Plate, 2-Screws	█
60420	MDC1418S20 (Units before 8/3/12)	Security Latch Kit for Body Mount: 1-Latch Plate, 2-Screws	█
60441	MDC1411T60	1-Latch Kit, Internal Mount	█
60480	MDC1411T60	1-Door Lock Block Kit, 1-Spanner Screw, 1-Washer	█
H06016	MDC1411T60	Transit Door Latch Replacement Kit: 1-Transit Latch, 2-Spanner Screws, 2-Barrel Nuts, 2-Fender Washers, 2-Star Washers	█
H05003	MDC1520T30, MDC1418T30(before 12/06)	Security Latch Strike Plate Kit	█

Menu Clip

CODE	PART FITS C.G. THIS PRODUCT	DESCRIPTION	█
MC1	MDC1520T16, MDC1418T16, MDC1520S20,(Units before 8/3/12) MDC1418S20,(Units before 8/3/12) MDC1520T30, MDC1418T30	1-Clip, 1-Roller, 1 Screw (Note: MDC1520T30 and MDC1418T30, ends only)	█
60391		1-Clip, 1-Roller, 1-Screw , 1-Locknut (door mounted)	█

MDC1520T30,
MDC1418T30,
MDC1520S20 (units
after 8/3/12)
MDC1418S20(After
8/3/12) MDC1520S10,
MDC1520S10HD



Distributed by
Comcater Pty Ltd
156 Swann Drive
Derrimut VIC 3030
Phone: (03) 8369 4600
Fax: (03) 8369 4696
www.comcater.com.au

Wheel

CODE	PART FITS C.G. THIS PRODUCT	DESCRIPTION
41030	MDC1520S20 (units before 5/18/13)	1-8" Center Wheel



Metric Camshelving® (Metric Sizes and Measurements)



-foodservice equipment-



Distributed by
Comcater Pty Ltd
156 Swann Drive
Derrimut VIC 3030
Phone: (03) 8369 4600
Fax: (03) 8369 4696
www.comcater.com.au

Posts-Metric Dimensions

CODE	C.G.	HEIGHT(CM)
MSP140	29	140
MSP150	29	150
MSP160	29	160
MSP170	29	170
MSP180	29	180

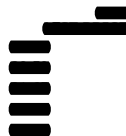

Traverses-Metric Dimensions

CODE	C.G.	WIDTH(CM)
MSTR60	29	60
MSTR70	29	70
MSTR80	29	80
MSTR90	29	90
MSTR100	29	100
MSTR110	29	110
MSTR120	29	120
MSTR130	29	130
MSTR140	29	140
MSTR150	29	150
MSTR160	29	160
MSTR170	29	170

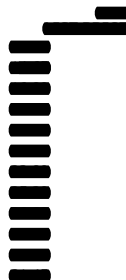

Post Connectors-Metric Dimensions

CODE	C.G.	WIDTH(CM)
MSPCT30	29	30
MSPCB30	29	30
MSPCT40	29	40
MSPCB40	29	40
MSPCT50	29	50
MSPCB50	29	50
MSPCT60	29	60
MSPCB60	29	60

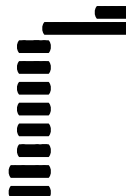

Corner Connectors-Metric Dimensions

CODE	C.G.	DESCRIPTION
MSCCR	29	Right Corner Connector
MSCCL	29	Left Corner Connector



Solid Shelf Plates-Metric Dimensions

CODE	C.G.	WIDTH(CM)	LENGTH(CM)
MS3030S	29	30	30
MS3040S	29	30	40
MS4030S	29	40	30
MS4040S	29	40	40
MS5030S	29	50	30
MS5040S	29	50	40
MS6030S	29	60	30
MS6040S	29	60	40



Vented Shelf Plates-Metric Dimensions

CODE	C.G.	WIDTH(CM)	LENGTH(CM)
MS3030V	29	30	30
MS3040V	29	30	40
MS4030V	29	40	30
MS4040V	29	40	40
MS5030V	29	50	30
MS5040V	29	50	40
MS6030V	29	60	30
MS6040V	29	60	40



Posts for Mobile Camshelving-Metric Dimensions

CODE	C.G.	HEIGHT W/CASTER(CM)
MSPR97	29	97
MSPR147	29	147
MSPR157	29	157
MSPR167	29	167
MSPR177	29	177



Metric Fence System for Camshelving® (Metric Sizes and Measurements)



COMCATER
foodservice equipment

Distributed by
Comcater Pty Ltd
 156 Swann Drive
 Derrimut VIC 3030
 Phone: (03) 8369 4600
 Fax: (03) 8369 4696
www.comcater.com.au

Fencing parts for Camshelving-Metric Dimensions

CODE	C.G. DESCRIPTION
MSFEB	29 Bracket End
MSFLB	29 Large Bracket
MSFSB	29 Small Bracket



Rods for Camshelving Fence-Metric Dimensions

CODE	C.G.	LENGTH(CM)
MSFR1086		108.58
MSFR1181		118.11
MSFR1289		129.90
MSFR1391		139.06
MSFR1489		148.91
MSFR1591		159.07
MSFR1692		169.23
MSFR203		20.32
MSFR305		30.48
MSFR406		40.64
MSFR505		50.58
MSFR591		59.05
MSFR686		68.58
MSFR787		78.74
MSFR889		88.9
MSFR991		99.06

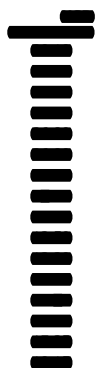

Organizers - Versa Line



12RS12



Distributed by
Comcater Pty Ltd
 156 Swann Drive
 Derrimut VIC 3030
 Phone: (03) 8369 4600
 Fax: (03) 8369 4696
www.comcater.com.au

PART FITS		
CODE	C.G. THIS PRODUCT	DESCRIPTION
45509	All Versa Organizers	1-Screw
45510	All Versa Organizers	1-Anchor
47262	All Organizers	1-Cylinder Style Bumpers



Portable CamBars®

DESIGNER SERIES CAMBAR® 650/730 AND STANDARD SERIES CAMBAR® 650/730



BAR650 - Standard Line



BAR650DS



BAR650DS - Designer Line



BAR650DSPMT



Distributed by
Comcater Pty Ltd
156 Swann Drive
Derrimut VIC 3030
Phone: (03) 8369 4600
Fax: (03) 8369 4696
www.comcater.com.au

DESIGNER SERIES CAMBAR® 730DS AND STANDARD SERIES CAMBAR® 730



BAR730 - Standard Line



BAR730DX



BAR730DS - Designer Line



BAR730PMT

Casters

CODE	PART FITS C.G.THIS PRODUCT	DESCRIPTION
60007	All Standard & Designer BAR540 Models	1-5" Swivel w/Brake Caster, 4-Bolts (60300)
60008	All Standard & Designer BAR540 Models	1-5" Swivel Caster, 4-Bolts (60300)

Caster Impact Plate

CODE	PART FITS C.G.THIS PRODUCT	DESCRIPTION
44018	All Standard & Designer BAR540 Models	1-5" Caster Impact Plate

Counter Tops Designer Series

CODE	PART FITS C.G.THIS PRODUCT	DESCRIPTION
60234	BAR540DS	1-Coal Color Counter Top
60235	BAR540DS	1-Slate Gray Color Counter Top
60253	BAR540DS	1-Cocoa Color Counter Top
60421	BAR540DS	1-Clip Plate, 6-Screws

Counter Tops Standard Series

CODE	PART FITS C.G.THIS PRODUCT	DESCRIPTION
6910	20 BAR540	1-Counter Top
60181	BAR540	1-Clip Plate, 6-Screws, 3-Star Washers

Cover

CODE	PART FITS C.G.THIS PRODUCT	DESCRIPTION
------	-------------------------------	-------------

S07007 All Standard & Designer BAR540 Models 1-Vinyl Cover



Distributed by
Comcater Pty Ltd
156 Swann Drive
Derrimut VIC 3030
Phone: (03) 8369 4600
Fax: (03) 8369 4696
www.comcater.com.au

Retainer Guard

CODE	PART FITS C.G.THIS PRODUCT	DESCRIPTION
BAR54RG	20 All Standard & Designer BAR540 Models	1-Retainer Guard

Threaded Faucet Drain

CODE	PART FITS C.G.THIS PRODUCT	DESCRIPTION
64005	All Standard & Designer BAR540 Models	1-Threaded Faucet Drain

CO2 Tank Retaining Chain

CODE	PART FITS C.G.THIS PRODUCT	DESCRIPTION
730CHN	All Pre-mix 650 and 730 CamBar Series	1-Chain

Casters

CODE	PART FITS C.G.THIS PRODUCT	DESCRIPTION
60033	All 650 and 730 CamBar Series	1-6" Swivel w/Brake Caster, w/fasteners (60300)
60034	All 650 and 730 CamBar Series	1-6" Swivel Caster, w/fasteners (60300)

Condiment Rack

CODE	PART FITS C.G.THIS PRODUCT	DESCRIPTION
730CONRK	All 730 CamBar Standard Series	1-Condiment Rack/Support (with 1/9 pans)

Counter Tops Designer Series

CODE	PART FITS C.G.THIS PRODUCT	DESCRIPTION
60238	All 650 CamBar Designer Series	1-Coal Color Counter Top, 6-Mount Brackets (60349), 36-Screws (60309)
60254	All 650 CamBar Designer Series	1-Cocoa Color Counter Top, 6-Mount Brackets (60349), 36-Screws (60309)
60245	All 730 CamBar Designer Series	1-Coal Color Counter Top, 6-Mount Brackets (60349), 36-Screws (60309)
60255	All 730 CamBar Designer Series	1-Cocoa Color Counter Top, 6-Mount Brackets (60349), 36-Screws (60309)

Covers

CODE	PART FITS C.G.THIS PRODUCT	DESCRIPTION
S07008	BAR650	1-Vinyl cover
S07009	BAR730	1-Vinyl cover

Drain Tube Retainer Clip

CODE	PART FITS C.G.THIS PRODUCT	DESCRIPTION
60100	All 650 and 730 CamBar Series	1-Clip, 1-Screw (60309)

Fresh Water Tank

CODE	PART FITS C.G.THIS PRODUCT	DESCRIPTION
730FWT	3 All PMT 650 and 730 CamBar Series	1-Fresh Water Tank, 1-Tank Cover, 2-Fittings, 1-Tubing
73321	All PMT 650 and 730 CamBar Series	1-Fresh Water Tank Cover
46037	All PMT 650 and 730 CamBar Series	1-Male Connector
46036	All PMT 650 and 730 CamBar Series	1-Female Connector
47249	All PMT 650 and 730 CamBar Series	1-2.5 Feet 3/8" ID Tubing

Ice Sink Cover

CODE	PART FITS C.G.THIS PRODUCT	DESCRIPTION
14510		1-Ice Sink Cover

All 650 and 730
CamBar Series



Distributed by
Comcater Pty Ltd
156 Swann Drive
Derrimut VIC 3030
Phone: (03) 8369 4600
Fax: (03) 8369 4696
www.comcater.com.au

Latch

CODE	PART FITS C.G.THIS PRODUCT	DESCRIPTION
60094	All 650 and 730 CamBar Series	Latch Kit: 1-Large Metal 4 Hole Latch, 4-Screws (60315)

Latch Hook Plate

CODE	PART FITS C.G.THIS PRODUCT	DESCRIPTION
60097	All 730 CamBar Series	1-Metal Latch Hook Plate, 2-Screws (60313)

Panel Kits Designer Series (Replacement Only: Cannot convert standard bar.)

CODE	PART FITS C.G.THIS PRODUCT	DESCRIPTION
60239	All 650 CamBar Designer Series	1- Carmel Designer-Dark Burl Color Front and Side Panel Kit
60240	All 650 CamBar Designer Series	1-Sedona Designer-Light Burl Color Front and Side Panel Kit
60241	All 650 CamBar Designer Series	1-Manhattan Designer-Brushed Pewter Color Front and Side Panel Kit
H09003	BAR650	1- Chicago Designer - Flat Pewter
60246	All 730 CamBar Designer Series	1- Carmel Designer-Dark Burl Color Front and Side Panel Kit
60247	All 730 CamBar Designer Series	1- Sedona Designer-Light Burl Color Front and Side Panel Kit
60248	All 730 CamBar Designer Series	1 Manhattan Designer-Brushed Pewter Color Front and Side Panel Kit
H09002	BAR730	1- Chicago Designer - Flat Pewter

Panel Front Sections Designer Series

CODE	PART FITS C.G.THIS PRODUCT	DESCRIPTION
6924	21 All 650 CamBar Designer Series	1-Front Body Section with Latches
6925	21 All 730 CamBar Designer Series	1-Front Body Section with Latches

Panel Tops/Fronts Standard Series

CODE	PART FITS C.G.THIS PRODUCT	DESCRIPTION
6654	21 BAR730, BAR730CP, BAR730DX, BAR730PM, BAR730PMT	1-Top/Front, 2-Latch Assemblies, 2-Hook Plates, 12 Screws (60313)
6926	21 BAR650, BAR650CP, BAR650DX, BAR650PM, BAR650PMT	1-Top with Hardware
6923	21 BAR650, BAR650CP, BAR650DX, BAR650PM, BAR650PMT	1-Front Panel with Hardware

Soda Line Retainer Kit

CODE	PART FITS C.G.THIS PRODUCT	DESCRIPTION
60099	All 650 and 730 CamBar Series	2-Retainer Clips, 2-Molly Bolts, 2-Screws (60319)

Standard Interior Vertical Support

CODE	PART FITS C.G.THIS PRODUCT	DESCRIPTION
60101	All 650 and 730 CamBar Series (except PM and PMT models)	1-Standard Interior Vertical Support, 6-Screws (60309)

Syrup Tank

CODE	PART FITS C.G.THIS PRODUCT	DESCRIPTION
730STP	All 650 and 730 CamBar Series	1-Tank Strap (2 Straps Minimum Order)
60098	All 650 and 730 CamBar Series	1-Tank Strap Bracket, 2-Screws

Waste Water Bin

CODE	PART FITS C.G.THIS PRODUCT	DESCRIPTION
------	-------------------------------	-------------

66561

All 650 and 730
CamBar Series

1-Waste Water Bin (7.7 Gallon)



COMCATER
Foodservice equipment



Distributed by
Comcater Pty Ltd
156 Swann Drive
Derrimut VIC 3030
Phone: (03) 8369 4600
Fax: (03) 8369 4696
www.comcater.com.au

Security Cage

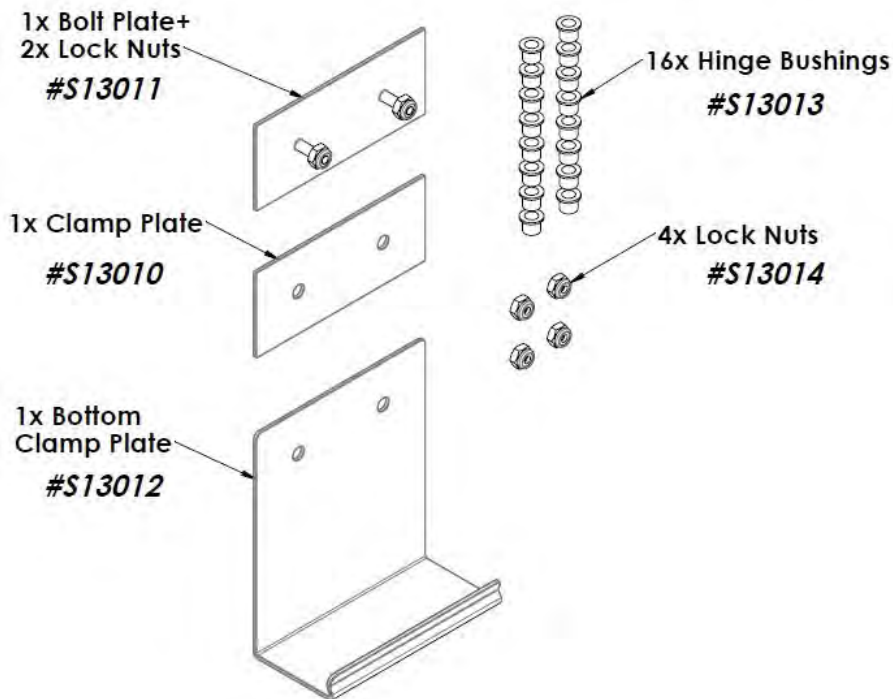

Distributed by
Comcater Pty Ltd
 156 Swann Drive
 Derrimut VIC 3030
 Phone: (03) 8369 4600
 Fax: (03) 8369 4696
www.comcater.com.au

Replacement Parts

CODE	PART FITS C.G. THIS PRODUCT	DESCRIPTION
S13010	CSSU2448	Clamp Plates SS
S13011	CSSU2448	Bolt Plate w/ Nuts SS
S13012	CSSU2448	Bottom Plates SS
S13013	CSSU2448	Hinge Bushing 16 Each
S13014	CSSU2448	Nut SS 10-32 3/3 W X 15/64 H



Service Carts



Distributed by
Comcater Pty Ltd
 156 Swann Drive
 Derrimut VIC 3030
 Phone: (03) 8369 4600
 Fax: (03) 8369 4696
www.comcater.com.au

Castors

CODE	PART FITS C.G. THIS PRODUCT	DESCRIPTION	
60006	Service Carts (except BC225)	1-5" Fixed Caster, 4-Bolts (60300)	■
60007	Service Carts (except BC225)	1-5" Swivel Caster w/Brake, 4-Bolts (60300)	■
60008	Service Carts (except BC225)	1-5" Swivel Caster, 4-Bolts (60300)	■
60009	Service Cart BC225	1-3" Fixed Caster, 4-Bolts (60300)	■
60352	Service Cart BC225, BC2254S	1-3" Swivel Caster, 4-Bolts (60300)	■
60040	Service Cart BC225, BC2254S	1-3" Swivel Caster w/Brake, 4-Bolts (60300)	■

Note: Castors not interchangeable.

SlidingLid™ for Food Boxes





Distributed by
Comcater Pty Ltd
 156 Swann Drive
 Derrimut VIC 3030
Phone: (03) 8369 4600
Fax: (03) 8369 4696
www.comcater.com.au

Note: Casters not interchangeable.

Lids

CODE	PART FITS C.G. THIS PRODUCT	DESCRIPTION
47334	All 1826CW Food Boxes	1-Base Lid
47335	1826SCCW Base, all 1826CW Food Boxes	1-Slider Lid
47332	All 1218CW Food Boxes	1-Base Lid
47333	1218SCCW Base, all 1218CW Food Boxes	1-Slider Lid

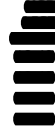

Thermal Servers

 Distributed by
Comcater Pty Ltd
 156 Swann Drive
 Derrimut VIC 3030
 Phone: (03) 8369 4600
 Fax: (03) 8369 4696
www.comcater.com.au



Lids

CODE	C.G.	PART FITS THIS PRODUCT	DESCRIPTION
6617	27	100TS, 180TS	1-Lid
6618	27	320TS	1-Lid
6619	27	480TS	1-Lid
6620	27	640TS	1-Lid



Note: Decaf (Orange-7) lids will be available until December 31, 2001 or until supplies are depleted, whichever comes first.

Top Loading Camcarriers®



Distributed by
Comcater Pty Ltd
 156 Swann Drive
 Derrimut VIC 3030
 Phone: (03) 8369 4600
 Fax: (03) 8369 4696
www.comcater.com.au

Note: Decaf (Orange-7) lids will be available until December 31, 2001 or until supplies are depleted, whichever comes first.



Doors

CODE	PART FITS C.G. THIS PRODUCT	DESCRIPTION	
6318	11 150MPC	1-Standard Door, 1-Gasket, 1-Vent Cap	

Gasket

CODE	PART FITS C.G. THIS PRODUCT	DESCRIPTION	
12109	125MPC, 140MPC, 160MPC, 180MPC	1-Gasket	
12102	150MPC	1-Gasket	
12110	240MPC	1-Gasket	

Hinges for Doors

CODE	PART FITS C.G. THIS PRODUCT	DESCRIPTION	
60012	150MPC	Hinge Kit: 1-Stainless Hinge, 3-Screws (60311), 3-Screws (60317)	

Lids

CODE	PART FITS C.G. THIS PRODUCT	DESCRIPTION	
6335	125MPC, 140MPC, 160MPC, 180MPC	1-Lid, 1-Gasket, 1-Vent Cap	
6343	240MPC	1-Lid, 1-Gasket, 1-Vent Cap	

Vent Cap



CODE	PART FITS C.G. THIS PRODUCT	DESCRIPTION	
14200	All Top Loading Camcarrier Models	1-Vent Cap	
H07001	All Top Loading Camcarrier Models	1-Black Pop-up Vent	

Latches

CODE	PART FITS C.G. THIS PRODUCT	DESCRIPTION	
60090	All Camcarriers	Metal Latch Kit: 1-Metal Latch, 1-Small 2 Hole Latch, 2-Screws (60315) Note: Mount plate has 6 holes, but is designed for 2-hole application.	
60092	All Camcarriers	Metal Latch Kit: 1 Metal Latch, 1-Small 4 Hole Latch, 4-Screws (60315)	
60264	All Camcarriers	1-Small Plastic Latch 2 Hole, 2-Screws (60315)	

Top Loading Ultra Pan Carrier® S-Series

Latches

CODE	PART FITS C.G. THIS PRODUCT	DESCRIPTION	
60422	UPCS140, UPCS160, UPCS180 (Units Before 12/03)	Nylon Latch Kit: 1-4" Black Nylon, 3-Screws	
60423	UPCS140, UPCS160, UPCS180 (Units After 12/03)	Nylon Latch Kit: 1-4" Black Nylon, 3-PT Screws	
60280	UPCS140, UPCS160, UPCS180	1-4" Nylon Latch, 5-Screws (60332)	

Lids

CODE	PART FITS C.G. THIS PRODUCT	DESCRIPTION	
7615	UPCS140, UPCS160, UPCS180	1-Lid, 1-Vent Cap	

Vent Cap

CODE	PART FITS C.G. THIS PRODUCT	DESCRIPTION	
14200	All Ultra Pan Carriers	1-Vent Cap	
H07001	All Ultra Pan Carriers	1-Black Pop-up Vent	



Distributed by
Comcater Pty Ltd
156 Swann Drive
Derrimut VIC 3030
Phone: (03) 8369 4600
Fax: (03) 8369 4696
www.comcater.com.au



Top Loading Ultra Pan Carriers®



Distributed by
Comcater Pty Ltd
 156 Swann Drive
 Derrimut VIC 3030
 Phone: (03) 8369 4600
 Fax: (03) 8369 4696
www.comcater.com.au

Gaskets

CODE	PART FITS C.G. THIS PRODUCT	DESCRIPTION
12109	UPC140, UPC160, UPC180	1-Gasket



Latches

CODE	PART FITS C.G. THIS PRODUCT	DESCRIPTION
60212	UPC140, UPC160, UPC180	Nylon Latch Kit: 1-4" Black Nylon, 4-Screws (60311)



Lids

CODE	PART FITS C.G. THIS PRODUCT	DESCRIPTION
7391	UPC140, UPC160, UPC180	1-Lid, 1-Gasket, 1-Vent Cap



Vent Cap

CODE	PART FITS C.G. THIS PRODUCT	DESCRIPTION
14200	All Ultra Pan Carriers	1-Vent Cap
H07001	All Ultra Pan Carriers	1-Black Pop-up Vent



Tray & Dish Carts

Caster Impact Plate

CODE	PART FITS C.G. THIS PRODUCT	DESCRIPTION
44018	All Carts	1-Impact Plate/Mount Plate

Casters

CODE	PART FITS C.G. THIS PRODUCT	DESCRIPTION
60032	All Carts	1-6" Fixed Caster, w/fasteners (60300)
60033	All Carts	1-6" Swivel Caster w/Brake, and fasteners (60300)
60034	All Carts	1-6" Swivel Caster, w/fasteners(60300)

Covers

CODE	PART FITS C.G. THIS PRODUCT	DESCRIPTION
TDC2029C	Tray & Dish Cart	1-Vinyl Cover



Distributed by
Comcater Pty Ltd
 156 Swann Drive
 Derrimut VIC 3030
 Phone: (03) 8369 4600
 Fax: (03) 8369 4696
www.comcater.com.au

Tray & Dish Carts - Adjustable

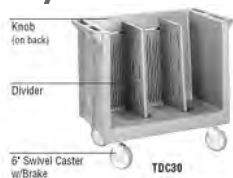

COMCATER
Foodservice equipment

Distributed by
Comcater Pty Ltd
 156 Swann Drive
 Derrimut VIC 3030
 Phone: (03) 8369 4600
 Fax: (03) 8369 4696
www.comcater.com.au

Caster Impact Plate		
CODE	C.G. THIS PRODUCT	DESCRIPTION
44018	Adjustable Carts	1-Impact Plate/Mount Plate

Casters		
CODE	C.G. THIS PRODUCT	DESCRIPTION
60032	All Carts	1-6" Fixed Caster, w/fasteners (60300)
60033	All Carts	1-6" Swivel Caster w/Brake, and fasteners (60300)
60034	All Carts	1-6" Swivel Caster, w/fasteners(60300)

Covers		
CODE	C.G. THIS PRODUCT	DESCRIPTION
TDC30C	Adjustable Tray & Dish Cart	1-Vinyl Cover

Dividers		
CODE	C.G. THIS PRODUCT	DESCRIPTION
TDC30D	Adjustable Tray and Dish Cart	Divider Kit 1-Divider, 1-Washer (45311), 1-Knob

Divider Hardware Kit		
CODE	C.G. THIS PRODUCT	DESCRIPTION
60096	Adjustable Tray and Dish Cart	1-Washer, 1-Knob
45311	Adjustable Tray and Dish Cart	1-Washer

Tray & Silver Cart

Caster Impact Plate

CODE	PART FITS C.G. THIS PRODUCT	DESCRIPTION
44018	All Carts	1-Impact Plate/Mount Plate

Casters

CODE	PART FITS C.G. THIS PRODUCT	DESCRIPTION
60032	All Carts	1-6" Fixed Caster, w/fasteners (60300)
60033	All Carts	1-6" Swivel Caster w/Brake, and fasteners (60300)
60034	All Carts	1-6" Swivel Caster, w/fasteners (60300)

Covers

CODE	PART FITS C.G. THIS PRODUCT	DESCRIPTION
14301	Tray & Silver Cart	1-Vinyl Cover



Distributed by
Comcater Pty Ltd
 156 Swann Drive
 Derrimut VIC 3030
Phone: (03) 8369 4600
Fax: (03) 8369 4696
www.comcater.com.au

COMCATER
Foodservice equipment



Distributed by
Comcater Pty Ltd
 156 Swann Drive
 Derrimut VIC 3030
 Phone: (03) 8369 4600
 Fax: (03) 8369 4696
 www.comcater.com.au

Ultra Camcarts® for Food Pans



Casters Polyurethane

CODE	PART FITS C.G. THIS PRODUCT	DESCRIPTION	
60006	UPC600	1-5" X 1 1/4" Fixed Caster, 4 Bolts (60300)	████████
60007	UPC600	1-5" X 1 1/4" Swivel Caster w/Brake, 4 Bolts (60300)	████████
60008	UPC600	1-5" X 1 1/4" Swivel Caster, 4-Bolts (60300)	████████
60032	UPC800, UPC1200, UPC1600	1-6" X 1 1/4" Fixed Caster w/Fasteners	████████
60033	UPC800, UPC1200, UPC1600	1-6" X 1 1/4" Swivel Caster w/Brake and w/Fasteners	████████
60034	UPC800, UPC1200, UPC1600	1-6" X 1 1/4" Swivel Caster w/Fasteners	████████
44018	UPC800, UPC1200, UPC600, UPC1600 (models before 3/08)	1" Caster Impact Plate for 5" and 6" casters	████████

Casters Hi-modulus rubber

CODE	PART FITS C.G. THIS PRODUCT	DESCRIPTION	
H11006	UPCD800- upgrades UPC800TR/UPC800SP	1-6" X 1.5" swivel caster w/brakes, 4 Pin-in-Torx Bolts	████████
H11005	UPC800- upgrades UPC800TR/UPC800SP	1-6" X 1.5" swivel, no brakes, 4-Pin-in-Torx Bolts	████████
H11004	UPC800- upgrades UPC800TR/UPC800SP	1-6" 1.5" rigid caster, 4-Pin-in-Torx Bolts	████████
H08001	UPC1600, UPC1600TR/SP, All 1600 models after 3/08	1-6" X 2" Swivel Caster, 4-Bolts, 4-Washers, 4-Nuts	████████
H08002	UPC1600, UPC1600TR/SP, All 1600 models after 3/08	1-6" X 2" Swivel Caster w/Brake, 4-Bolts, 4-Washers, 4-Nuts	████████
H08003	UPC1600, UPC1600TR/SP, All 1600 models after 3/08	1-6" X 2" Fixed Caster, 4-Bolts, 4-Washers, 4-Nuts	████████

Chassis Plate Kits

CODE	PART FITS C.G. THIS PRODUCT	DESCRIPTION	
60226	UPC1600TR, (models before 3/08) UPC1200TR	1-Chassis Plate, 8-Screws per Plate	████████
60227	UPC800TR/SP	1-Chassis Plate, 8-Screws per Plate	████████
H08004	UPC1600 (models after 3/01/08), All UPCH1600 models	1-Chassis Plate, 16-Bolts, 16-Washers	████████

Doors

CODE	PART FITS C.G. THIS PRODUCT	DESCRIPTION	
7601	UPC600	1-Standard Door, 3-Pivot Pins, 1-Gasket, 1-Vent Cap	████████
7341	UPC800	1-Top Standard Door, 1-13" Hinge Pin, 1-Pin, 1-Clip, 1-Bushing, 1-Gasket, 1-Vent Cap	████████
7342	UPC800	1-Bottom Standard Door, 1-13" Hinge Pin, 1-Pin, 1-Clip, 1-Bushing, 1-Gasket, 1-Vent Cap	████████
7604	UPC1200	1-Standard Door, 3-Pivot Pins, 1-Gasket, 1-Vent Cap	████████
7348	UPC1600	1-Top Standard Door, 1-13" Hinge Pin, 1-Pin, 1-Clip, 1-Bushing, 1-Gasket, 1-Vent Cap	████████
7349	UPC1600	1-Bottom Standard Door, 1-13" Hinge Pin, 1-Pin, 1-Clip, 1-Bushing, 1-Gasket, 1-Vent Cap	████████

Gaskets

CODE	PART FITS C.G. THIS PRODUCT	DESCRIPTION
12139	UPC1200	1-Gasket
12102	UPC600	1-Gasket
12119	UPC400, UPC800,UPC400SP, UPC800SP	1-Gasket
12128	UPC1600,UPC1600SP	1-Gasket



Distributed by
Comcater Pty Ltd
156 Swann Drive
Derrimut VIC 3030
Phone: (03) 8369 4600
Fax: (03) 8369 4696
www.comcater.com.au

Hinges for Doors

CODE	PART FITS C.G. THIS PRODUCT	DESCRIPTION
42133	UPC800, UPC1600	1-Hinge Pin Lock Clip
42136	UPC800, UPC1600	1-13" Nylon Hinge Pin
42128B	UPC600, UPC800, UPC1200, UPC1600	1- Aluminum Hinge Pivot Pin (smaller pin)



Latches

CODE	PART FITS C.G. THIS PRODUCT	DESCRIPTION
60094	All Camcarts (Units Before 1/06), Excluding All Security Packages	Latch Kit: 1-Large Metal 4 Hole Latch, 4-Screws (60315)
60135	UPC600, UPC800, UPC1200, UPC1600,	1-9" Nylon Latch, 5-Screws (60311) (Includes all Celsius and Fahrenheit Models)
60373	UPC1600TR/SP	9" Latch Kit with Tamper Resistant Screws

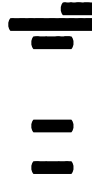

Locking Hasps

CODE	PART FITS C.G. THIS PRODUCT	DESCRIPTION
H06013	UPC400,UPC400TR/SP, UPC800, UPC800TR/SP, UPC1200,UPC1600, UPC1600TR/SP	Locking Lock Hasp Kit: 1-Angled Hasp Plate, 1-Flat Hasp Plate, 9-Spanner Screws, 1-Spanner Drive Bit



Vent Cap

CODE	PART FITS C.G. THIS PRODUCT	DESCRIPTION
14200	All Camcarts (models before 2005)	1-Vent Cap
H07001	All Camcarts (models after 2005)	1-Black Pop-up Vent



Ultra Camtainers®



Distributed by
Comcater Pty Ltd
 156 Swann Drive
 Derrimut VIC 3030
 Phone: (03) 8369 4600
 Fax: (03) 8369 4696
 www.comcater.com.au



Faucet and Spout

CODE	C.G. THIS PRODUCT	DESCRIPTION	
PART FITS			
60267	Ultra Camtainers	Faucet Kit: 1-Faucet, 1-Wing Nut (45401), 1-Rubber Seat Cup (46010)	
64003	Ultra Camtainers	Spout Kit: 1-Nylon Spout, 1- "C" Ring (46008), 1-Flat Washer (12304), 1-Fiber Washer (45307), 1-Hex Nut (45400)	
12307	Ultra Camtainers	1-Flat Washer	
45307	Ultra Camtainers	1-Fiber Washer	
45400A	Ultra Camtainers	1-Hex Nut	
45401A	Ultra Camtainers	1-Wing Nut	
46008	Ultra Camtainers	1-"C" Ring	
46010	Ultra Camtainers	1-Rubber Seat Cup (46010)	
47219	Ultra Camtainers	1-Solid Nylon Plug (Converting LCD's to Soup Carrier)	

Gaskets

CODE	C.G. THIS PRODUCT	DESCRIPTION	
PART FITS			
12117	UC250, UC500	1-Gasket	
12130	UC1000	1-Gasket	

Label Sets

CODE	C.G. THIS PRODUCT	DESCRIPTION	
PART FITS			
13201	UC250, UC500, UC1000	6-Imprinted Beverage Label Set, Small Label	

Latches

CODE	C.G. THIS PRODUCT	DESCRIPTION	
PART FITS			
60135	All Ultra Camtainers	Latch Kit: 1-Black Nylon Latch, 5-Screws (60311)	

Lids

CODE	C.G. THIS PRODUCT	DESCRIPTION	
PART FITS			
7354	UC250, UC500	1-Lid, 1-Gasket, 1-Vent Pop up Vent Cap (H07001)	
7356	UC1000	1-Lid, 1-Gasket, 1-Vent Pop up Vent Cap (H07001)	

Vent Caps

CODE	C.G. THIS PRODUCT	DESCRIPTION	
PART FITS			
14200	All Camtainers and Ultra Camtainers	1-Vent Cap (models before 1-07)	
H07001	All Camtainers and Ultra Camtainers	1-Black Pop-up Vent	

Plug Kit

CODE	C.G. THIS PRODUCT	DESCRIPTION	
PART FITS			
H14004	All Camtainers and Ultra Camtainers	Camtainer Plug Kit: Plug, Washers, Hex Nuts	

US Camshelving® (US Sizes and Measurements)



Distributed by
Comcater Pty Ltd
156 Swann Drive
Derrimut VIC 3030
Phone: (03) 8369 4600
Fax: (03) 8369 4696
www.comcater.com.au



Stationary Posts for Camshelving-US Dimensions

CODE	C.G.HEIGHT(IN.)	HEIGHT(CM)
CSP32	28 32"	81,3
CSP56	28 56"	142,0
CSP64	28 64"	162,6
CSP72	28 72"	182,9
CSP84	28 84"	213,4



Mobile Posts for Camshelving-US Dimensions

CODE	C.G.W/CASTER(IN.)	HEIGHT W/CASTER(CM)
CSPR35	28 35"	88,9
CSPR59	28 59"	149,9
CSPR67	28 67"	170,2
CSPR75	28 75"	190,5



Traverses-US Dimensions

CODE	C.G.WIDTH	WIDTH
CSTR24	28 24"	61,0 cm
CSTR30	28 30"	76,2 cm
CSTR36	28 36"	91,4 cm
CSTR42	28 42"	106,7 cm
CSTR48	28 48"	121,9 cm
CSTR54	28 54"	137,2 cm
CSTR60	28 60"	152,4 cm
CSTR72	28 72"	182,9 cm



Post Connectors-US Dimensions

CODE	C.G.DESCRPTION	WIDTH
CSPCT14	28 Top Post Connector	14" (35,6 cm)
CSPCB14	28 Bottom Post Connector	14" (35,6 cm)
CSPCT18	28 Top Post Connector	18" (45,7 cm)
CSPCB18	28 Bottom Post Connector	18" (45,7 cm)
CSPCT21	28 Top Post Connector	21" (53,3 cm)
CSPCB21	28 Bottom Post Connector	21" (53,3 cm)
CSPCT24	28 Top Post Connector	24" (61,0 cm)
CSPCB24	28 Bottom Post Connector	24" (61,0 cm)



Corner Connectors-US Dimensions

CODE	C.G.DESCRPTION
CSCCR	28 90° Right Corner Connector
CSCCL	28 90° Left Corner Connector



Solid Shelf

Solid Shelf Plates-US Dimensions

CODE	C.G.WIDTH	LENGTH
CS146S	28 14" (35,6 cm)	6" (15,2 cm)
CS1411S	28 14" (35,6 cm)	11" (27,9 cm)
CS1412S	28 14" (35,6 cm)	12" (30,5 cm)
CS1418S	28 14" (35,6 cm)	18" (45,7 cm)
CS186S	28 18" (45,7 cm)	6" (15,2 cm)
CS1811S	28 18" (45,7 cm)	11" (27,9 cm)
CS1812S	28 18" (45,7 cm)	12" (30,5 cm)
CS1818S	28 18" (45,7 cm)	18" (45,7 cm)
CS216S	28 21" (53,3 cm)	6" (15,2 cm)
CS2111S	28 21" (53,3 cm)	11" (27,9 cm)
CS2112S	28 21" (53,3 cm)	12" (30,5 cm)
CS2118S	28 21" (53,3 cm)	18" (45,7 cm)
CS246S	28 24" (61,0 cm)	6" (15,2 cm)
CS2411S	28 24" (61,0 cm)	11" (27,9 cm)
CS2412S	28 24" (61,0 cm)	12" (30,5 cm)
CS2418S	28 24" (61,0 cm)	18" (45,7 cm)

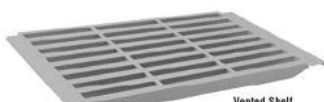

Vented Shelf

Vented Shelf Plates-US Dimensions

CODE	C.G.WIDTH	LENGTH
CS146V	28 14" (35,6 cm)	6" (15,2 cm)
CS1411V	28 14" (35,6 cm)	11" (27,9 cm)
CS1412V	28 14" (35,6 cm)	12" (30,5 cm)
CS1418V	28 14" (35,6 cm)	18" (45,7 cm)
CS186V	28 18" (45,7 cm)	6" (15,2 cm)
CS1811V	28 18" (45,7 cm)	11" (27,9 cm)
CS1812V	28 18" (45,7 cm)	12" (30,5 cm)
CS1818V	28 18" (45,7 cm)	18" (45,7 cm)
CS216V	28 21" (53,3 cm)	6" (15,2 cm)
CS2111V	28 21" (53,3 cm)	11" (27,9 cm)
CS2112V	28 21" (53,3 cm)	12" (30,5 cm)
CS2118V	28 21" (53,3 cm)	18" (45,7 cm)
CS246V	28 24" (61,0 cm)	6" (15,2 cm)
CS2411V	28 24" (61,0 cm)	11" (27,9 cm)
CS2412V	28 24" (61,0 cm)	12" (30,5 cm)
CS2418V	28 24" (61,0 cm)	18" (45,7 cm)





Distributed by
Comcater Pty Ltd
 156 Swann Drive
 Derrimut VIC 3030
 Phone: (03) 8369 4600
 Fax: (03) 8369 4696
www.comcater.com.au

Post Leveling Foot-US Dimensions

CODE	C.G.DESCRPTION
CSLF	28 Leveling foot to level



ID Tag-US Dimensions

CODE	C.G.DESCRPTION
CSIDL	12-Labels



US Camshelving® Wallshelving (US Sizes and Measurements)





Distributed by
Comcater Pty Ltd

156 Swann Drive
Derrimut VIC 3030
Phone: (03) 8369 4600
Fax: (03) 8369 4696
www.comcater.com.au



Wall Shelving

CODE	C.G. DESCRIPTION
CSWB 28	1-Wall Shelf Bracket, 4-lag screws, 4 washers
CSWS36 28	1-36" Wall Shelf
CSWS48 28	1-48" Wall Shelf
CSWS1836S48Q-36"	Wall Shelf Solid, 18" Width
CSWS1848S48Q-48"	Wall Shelf Solid, 18" Width
CSWS1436S48Q-36"	Wall Shelf Solid, 14" Width
CSWS1436V48Q-36"	Wall Shelf Vented, 14" Width
CSWS1448S48Q-48"	Wall Shelf Solid, 14" Width
CSWS1448V48Q-48"	Wall Shelf Vented, 14" Width
CSWB14	1-Bracket
S06001	1-Peg Strip, 36" Long
S06002	1-Peg Strip, 48" Long
S06003	3-Peg Hooks
S06004	3-Peg Strip Screws
H06003	2-Lag Screws, 2-Washers
CSSE	Extender



US Fence System for Camshelving® (US Sizes and Measurements)

COMCATER
Foodservice equipment

Distributed by
Comcater Pty Ltd
 156 Swann Drive
 Derrimut VIC 3030
 Phone: (03) 8369 4600
 Fax: (03) 8369 4696
www.comcater.com.au



Fencing parts for Camshelving-US Dimensions

CODE	C.G. DESCRIPTION
CSFEB	28 Bracket End
CSFLB	28 Large Bracket
CSFSB	28 Small Bracket



Rods for Camshelving Fencing-US Dimensions

CODE	C.G. LENGTH
CSFR1378	137/8"
CSFR1678	167/8"
CSFR1978	197/8"
CSFR2012	201/2"
CSFR2612	261/2"
CSFR3212	321/2"
CSFR3812	381/2"
CSFR4412	441/2"
CSFR5012	501/2"
CSFR5612	561/2"
CSFR6812	681/2"
CSFR978	97/8"

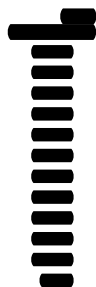

Utility Trucks



2436UTHS



2030UT



Distributed by
Comcater Pty Ltd
 156 Swann Drive
 Derrimut VIC 3030
 Phone: (03) 8369 4600
 Fax: (03) 8369 4696
www.comcater.com.au

Casters

CODE	PART FITS C.G. THIS PRODUCT	DESCRIPTION
60006	Utility Trucks	1-5" Fixed Caster, 4-Bolts (60300)
60007	Utility Trucks	1-5" Swivel w/Brake Caster, 4-Bolts (60300)
60008	Utility Trucks	1-5" Swivel Caster, 4-Bolts (60300)



Handles

CODE	PART FITS C.G. THIS PRODUCT	DESCRIPTION
60285	2030UT	Handle Kit: 1-Chrome Handle, 4-Screws (60333)



Impact Plate

CODE	PART FITS C.G. THIS PRODUCT	DESCRIPTION
60284	2436UTH, 2436UTHS	1-Impact Plate, 4-Bolts (60300)



Strap with Buckle

CODE	PART FITS C.G. THIS PRODUCT	DESCRIPTION
45155	2436UTH, 2436UTHS	1-Strap with buckle 200" long



Versa Cart



-foodservice equipment-



Distributed by
Comcater Pty Ltd
 156 Swann Drive
 Derrimut VIC 3030
Phone: (03) 8369 4600
Fax: (03) 8369 4696
www.comcater.com.au

CASTERS

CODE	PART FITS C.G. THIS PRODUCT	DESCRIPTION
60033	All Versa Carts	1 - 6" Standard Swivel Caster w/ Brake, and fasteners(60300)
H10001	All Versa Carts	1 - 6" Heavy Duty Swivel Caster w/Brake, 4 - Hex Bolts (45116), 4 - Flat Washers (45330)
S10030	All Versa Carts	1 - Aluminum Chassis Plate (for 2 Casters)

HARDWARE KITS

CODE	PART FITS C.G. THIS PRODUCT	DESCRIPTION
H10014	All Versa Carts	1 - Hardware Kit for Drawer Lock
H10016	All Versa Carts	1 - Hardware Kit for Tray Rail (Cart Only)
H10015	All Versa Carts	1 - Hardware Kit for Security Bracket
H10017	All Versa Carts	1 - Hardware Kit for Connectors
H10020	All Versa Carts	1 - Hardware Kit for Front Access Panel
H10022	All Versa Carts	1 - Hardware Kit for Adjustable Shelf
H10021	All Versa Carts	1 - Hardware Kit for Countertop

FRONT ACCESS PANEL KIT

CODE	PART FITS C.G. THIS PRODUCT	DESCRIPTION
C10007	All Versa Carts	1 - Access Panel, 2 - Truss Head Screws (45257), 2 - Flat Washers (45323)

COUNTERTOP PLUGS

CODE	PART FITS C.G. THIS PRODUCT	DESCRIPTION
C10008	All Versa Carts	1 - Full Plug, 1 - Split Plug

ADJUSTABLE SHELF KIT

CODE	PART FITS C.G. THIS PRODUCT	DESCRIPTION
C10009	All Versa Carts	1 - Shelf, 1 - Nylon Thumbscrew (45147), 1 - Nylon Flat Washer (47375)

INSIDE WALL PLUGS

CODE	PART FITS C.G. THIS PRODUCT	DESCRIPTION
H10019	All Versa Carts	12 - Black Snap-In Plugs

DRAWER

CODE	PART FITS C.G. THIS PRODUCT	DESCRIPTION
C10006	All Versa Carts	1 - Drawer

DÉCOR PANELS

CODE	PART FITS C.G. THIS PRODUCT	DESCRIPTION
S10028	All Versa Carts	1 - Décor Panel, Brushed Steel
S10029	All Versa Carts	1 - Décor Panel, Bronze

CONNECTOR EXTENSION

CODE	PART FITS C.G. THIS PRODUCT	DESCRIPTION
C10010	All Versa Carts	1 - Extension

ASSET MANAGEMENT LABELS

CODE	PART FITS C.G. THIS PRODUCT	DESCRIPTION
S10001	All Versa Carts	4-Labels

Versa Food Bar and Versa Work Table



Distributed by
Comcater Pty Ltd
156 Swann Drive
Derrimut VIC 3030
Phone: (03) 8369 4600
Fax: (03) 8369 4696
www.comcater.com.au



CASTERS

CODE	PART FITS C.G. THIS PRODUCT	DESCRIPTION
60033	All Versa Bars and Tables	1 - 6" Standard Swivel Caster w/ Brake, and fasteners(60300)
H10001	All Versa Bars and Tables	1 - 6" Heavy Duty Swivel Caster w/Brake, 4 - Hex Bolts (45116), 4 - Flat Washers (45330)
44018	All Versa Bars and Tables	1 - Caster Impact Plate

DRAIN FAUCET KIT

CODE	PART FITS C.G. THIS PRODUCT	DESCRIPTION
H10004	All Versa Bars and Tables	1 - Bronze Plastic Hose BIB Faucet, 1 - O-Ring Seal

TENSION ROD KIT FOR BODY

CODE	PART FITS C.G. THIS PRODUCT	DESCRIPTION
H10002	All Versa Bars and Tables	1 - Aluminum Rod w/ Threaded End, 2 - Flat Head Screws (45143)
H10005	All Versa Bars and Tables	1 - Base Mount Bracket, 3 - Bolts (45116), 3 - Flat Washers (45330)

HARDWARE KITS

CODE	PART FITS C.G. THIS PRODUCT	DESCRIPTION
H11001	All Versa Bars and Tables	1 - Hardware Kit (4 screws) to lock tray rail in place
H10006	All Versa Bars and Tables	1 - Hardware Kit for Tray Rails
H10003	All Versa Bars and Tables	1 - Hardware Kit for End Table, Connectors and Sneeze Guard Tower
H10007	All Versa Bars and Tables	1 - Hardware Kit for Leg
H10008	All Versa Bars and Tables	1 - Hardware Kit for Sneeze Guard Top Shelf
H10010	All Versa Bars and Tables	1 - Hardware Kit for Merchandiser Sign
H10009	All Versa Bars and Tables	1 - Hardware Kit for Sneeze Guard End Guard

SNEEZE GUARD TOWER AND ARM KIT

CODE	PART FITS C.G. THIS PRODUCT	DESCRIPTION
C10005	All Versa Bars and Tables	1 - Sneeze Guard Tower with L/R Arms Installed, 2 - Nylon Thumbscrews (45147), 2 - Flat Washers (47375)

SNEEZE GUARD END GUARD KITS

CODE	PART FITS C.G. THIS PRODUCT	DESCRIPTION
C10001	All Versa Bars and Tables	1 - Left End Guard, 1- Clear Panel Insert, 2 - Nylon Thumbscrews (45125), 2 - SS Fender Washers (45150)
C10002	All Versa Bars and Tables	1 - Right End Guard, 1- Clear Panel Insert, 2 - Nylon Thumbscrews (45125), 2 - SS Fender Washers (45150)

SNEEZE GUARD TOP SHELF KITS

CODE	PART FITS C.G. THIS PRODUCT	DESCRIPTION
C10003	All Versa Bars and Tables	1 - 5' Top Shelf, 2 - Black Knob Thumbscrews (45750), 2 - Finish Washers (45362), 4 - Nylon Insert Plugs (47258)
C10004	All Versa Bars and Tables	1 - 6' Top Shelf, 2 - Black Knob Thumbscrews (45750), 2 - Finish Washers (45362), 4 - Nylon Insert Plugs (47258)

SNEEZE GUARD PANELS

CODE	PART FITS C.G. THIS PRODUCT	DESCRIPTION
S10025	All Versa Bars and Tables	1- Sneeze Guard End Panel
S10026	All Versa Bars and Tables	1- Sneeze Guard Side Panel 5' VBR
S10027	All Versa Bars and Tables	1- Sneeze Guard Side Panel 6' VBR

LEG KITS (Hardware Not Included)

CODE	PART FITS C.G. THIS PRODUCT	DESCRIPTION
C10011	All Standard Height Versa Bars and Tables	1 - Leg, Standard Height, 2 - Décor Panel Rails Installed
C10012	All Low Height Versa Bars and Tables	1 - Leg, Low Height, 2 - Décor Panel Rails Installed

END TABLE SUPPORT RODS

PART FITS		
CODE	C.G. THIS PRODUCT	DESCRIPTION
S10065	All Versa Food Bars and End Tables	1 - End Table Adjustable Support Rod





Distributed by
Comcater Pty Ltd
156 Swann Drive
Derrimut VIC 3030
Phone: (03) 8369 4600
Fax: (03) 8369 4696
www.comcater.com.au



ASSET MANAGEMENT LABELS

PART FITS		
CODE	C.G. THIS PRODUCT	DESCRIPTION
S10001	All Versa Bars and Tables	4 - Labels



TOP SHELF INSERT PLUGS

PART FITS		
CODE	C.G. THIS PRODUCT	DESCRIPTION
S10002	All Versa Bars and Tables	12 - Plugs



DÉCOR LEG PANELS

PART FITS		
CODE	C.G. THIS PRODUCT	DESCRIPTION
S10017	All Standard Height Versa Bars and Tables	1 - Décor Leg Panel for Standard Height Bars/Tables, Brushed Steel
S10018	All Standard Height Versa Bars and Tables	1 - Décor Leg Panel for Standard Height Bars/Tables, Bronze
S10019	All Low Height Versa Bars and Tables	1 - Décor Leg Panel for Low Height Bars/Tables, Brushed Steel
S10020	All Low Height Versa Bars and Tables	1 - Décor Leg Panel for Low Height Bars/Tables, Bronze



Versa Food Bar LED Lighting

PART FITS		
CODE	C.G. THIS PRODUCT	DESCRIPTION
LEDBATTERY	All Versa Food Bars	12 Volt Battery for Light Only
LEDBATTKIT	All Versa Food Bars	12 Volt Battery and Wall Charger (with a standard 5-15p plug, operates On 100-240 VAC) for Light Only
LED54LIGHT	All Versa Food Bars	LED Light Strip 54" Long and Mounting Brackets Only



Wine Cooler/ Bucket



Distributed by
Comcater Pty Ltd
 156 Swann Drive
 Derrimut VIC 3030
 Phone: (03) 8369 4600
 Fax: (03) 8369 4696
www.comcater.com.au

Handle Assembly

CODE	PART FITS C.G. THIS PRODUCT	DESCRIPTION
60020	Bucket, Pedestal Base	Handle Kit: 1-Handle, 1-Rosette, 1-Screw, 1-Washer
14400	Bucket, Pedestal Base	1-Handle



Work Station

Towel Holder

Well Cover



KWS40



Distributed by
Comcater Pty Ltd
 156 Swann Drive
 Derrimut VIC 3030
 Phone: (03) 8369 4600
 Fax: (03) 8369 4696
www.comcater.com.au

Doors

CODE	PART FITS C.G. THIS PRODUCT	DESCRIPTION	
60195	KWS40	1-Latch Strike Plate, 4-Screws (60131), 4-Star Washers (60340)	
46038	KWS40	1-Three Lobe Knob, 1-Sink Top Stud	
7375	1 KWS40	Left Door w/Hardware: 1-Left Door, 2-Pivot Pin (42128B), 1-3" Hinge Pin (42238), 1-Pin Lock Clip (42133), 1-Latch Hook (60196), 2-Star Washers (60339), 2-Screws (60321)	
7376	1 KWS40	Right Door w/Hardware: 1-Right Door, 2-Pivot Pin (42128B), 1-3" Hinge Pin (42238), 1-Pin Lock Clip (42133), 1-Latch Hook (60196), 2-Star Washers (60339), 2-Screws (60321)	
60196	KWS40	1-Latch Hook, 2-Screws (60321), 2-Star Washers (60339)	
42128B	KWS40	1-Aluminum Hinge .Pivot Pin	
42238	KWS40	1- 3" Hinge Pin	
42133	KWS40	1-Pin Lock Clip	

Casters

CODE	PART FITS C.G. THIS PRODUCT	DESCRIPTION	
60032	KWS40	1-Left Side Caster 6" Rigid Type, w/fasteners (60300)	
60033	KWS40	1-Right Side Caster 6" Swivel w/Brake, and fasteners (60300)	
44018	KWS40	1-Impact Plate	

Towel Holder

CODE	PART FITS C.G. THIS PRODUCT	DESCRIPTION	
47505	KWS40	1-Towel Saver Paper Towel Holder	

Well Cover

CODE	PART FITS C.G. THIS PRODUCT	DESCRIPTION	
S06006	KWS40	1-Knob, 1-Bolt	

[Terms of Use](#) ©2007 Cambro Manufacturing Company. All Rights Reserved.
 5801 Skylab Road, Huntington Beach, CA 92647