

2019 CATALOG INTERNATIONAL



CFS BRANDS®



Get to know CFS Brands

Combining the leading names in foodservice, healthcare and sanitary maintenance, San Jamar joins Carlisle FoodService Products, Dinex, Sparta Brush, Snap Drape, Marko and others to offer expanded product choice, services and leadership to the marketplace.

Learn more about CFS Brands at www.cfsbrands.com.

CONTENTS

2 SAN JAMAR PRODUCTS

- 2 San Jamar color swatches
- 4 **Counter Service**
 - Cup Lid and Straw Dispensers
 - Countertop Organizers
 - Pump Centers
 - Napkin Dispensers
- 22 **Food Safety Tools**
 - Cutting Boards
 - Safe Food Prep
 - Safe Ice Handling
- 36 **Bar & Food Management**
 - Food Management
 - Bar Management
 - Tools
- 44 **Personal Safety**
 - Temperature Protection Gloves
 - Temperature Protection Mitts
 - Cut Protection
- 56 **Washroom & Hygiene Solutions**
 - Towel Dispensers
 - Tissue Dispensers
 - Soap and Other Dispensers
 - Air Care

72 CARLISLE FOODSERVICE PRODUCTS

- 72 Dinnerware
- 80 Drinkware
- 94 Tabletop Accessories
- 102 Marcko
- 104 Displayware
- 114 Convenience Products
- 124 Bar Supplies
- 132 Foodservice Trays
- 140 Catering Equipment
- 146 Kitchen Accessories
- 156 Storage & Handling
- 166 Warewashing
- 178 Floor Care
- 184 Transportation
- 190 Waste Management

194 INDEX

- 202 Terms & Conditions

ICON KEY



Food Safe



Dishwasher Safe



Product meets NSF certification standards



Compliant with health, safety, and environmental protection standards for products sold within the European Economic Area



Product does not contain the chemical Bisphenol A



Product can be dispensed without touching the dispenser for a more hygienic environment

SAN JAMAR PRODUCT SWATCH KEY



Black



Black Stainless
Look



Blue
(Cutting Board)



Blue
(Kleen-Pail)



Brown



Clear



Frosted Blue



Green



Gray



Allergen
Purple



Red



Satin Chrome



Sand



Stainless Steel
(Counter Service)



Stainless Steel Look
(Washroom)

SUMMIT CUSTOM PRE-APPROVED COLORS



Black



White



Brown



Yellow



Orange



Red



Black Pearl



Arctic Blue



Bronze



Tuff Cut
Material



Taupe



White



White Clear



Wine



Satin
Stainless



Chrome



Yellow



Maroon



Purple



Blue



Dark Blue



Green



Dark Green



 **san jamar**[®]
smart. safe. sanitary.



COUNTER SERVICE



C6400C

Stainless Steel Counter-Mount Beverage Cup **NEW**

Item	Rim Diameter	Cup Size	Counter Hole Diameter	Tube Length	Pack
C6200C	64-79 mm	177-296 ml	106 mm	597 mm	6
C6400C	76-98 mm	355-710 ml	119 mm	597 mm	6
C6500C	101-117 mm	950-1360 ml	146 mm	597 mm	6

Construction: 26-gauge stainless steel

Stainless Steel Surface-Mount (Elevator) Beverage Cup



C3200EV

C3400EV

C3500EV

Item	Rim Diameter	Cup Size	Tube Length	Pack
C3200EF C3200EH C3200EV	56-81 mm	177-300 ml	604 mm	6
C3400EF C3400EH C3400EV	70-98 mm	350-710 ml	604 mm	6
C3500EF C3500EH C3500EV	101-124 mm	950-1360 ml	604 mm	6

Construction: 26-gauge stainless steel

Stainless Steel Pull-Type Beverage Cup



C3200P

C3400P

C3500P

Item	Rim Diameter	Cup Size	Tube Length	Pack
C3200P	56-81 mm	177-300 ml	597 mm	6
C3400P	70-98 mm	350-710 ml	597 mm	6
C3500P	101-124 mm	950-1360 ml	597 mm	6

Construction: 26-gauge stainless steel

HOW TO CHOOSE YOUR
STAINLESS STEEL SURFACE-MOUNT
CUP DISPENSER

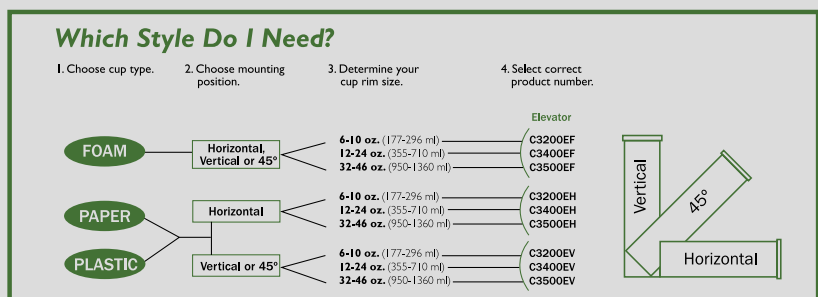

Small Pull-Type Water Cup

Item	Color	Rim Diameter	Cup Size	Tube Length	Pack
CONSTRUCTION: 26-GAUGE STAINLESS STEEL					
C4150SS	SS	57-73 mm	Cone 90-130 ml Flat 90-150 ml	406 mm	12
CONSTRUCTION: HIGH-IMPACT RESISTANT PLASTIC					
C4160*	WH, TBL	57-73 mm	Cone 90-130 ml Flat 90-150 ml	406 mm	24



Small Pull-Type Water Cup with Throat

Item	Color	Rim Diameter	Cup Size	Tube Length	Pack
CONSTRUCTION: HIGH-IMPACT RESISTANT PLASTIC					
C4180*	TBR, TBL, TBLW, CL	57-73 mm	Cone 90-130 ml Flat 90-150 ml	406 mm	12

Note: TBLW = Arctic Blue includes white flip cap to allow refilling without removing cap



Medium Pull-Type Water Cup

Item	Color	Rim Diameter	Cup Size	Tube Length	Pack
CONSTRUCTION: HIGH-IMPACT RESISTANT PLASTIC					
C3165*	WH, TBL, FBL, BK	64-83 mm	Cone 4120-300 ml Flat 120-300 ml	406 mm	24
C3165TBL20	TBL	64-83 mm	Cone 120-300 ml Flat 120-300 ml	508 mm	

Includes flip cap to allow refilling without removing cap



Large Pull-Type Water Cup

Item	Color	Rim Diameter	Cup Size	Tube Length	Pack
CONSTRUCTION: 26-GAUGE STAINLESS STEEL					
C3250SS	SS	70-86 mm	Cone 130-210 ml) Flat 180-350 ml	406 mm	6
C3450SS	SS	82-98 mm	Cone 240-350 ml Flat 350-710 ml	406 mm	6
CONSTRUCTION: HIGH-IMPACT RESISTANT PLASTIC					
C3260*	TBR, TBL	70-86 mm	Cone 130-210 ml Flat 180-350 ml	406 mm	6



EZ-FIT® CUP DISPENSERS

- Interchangeable gaskets allow for cup sizes to be changed easily
- Four different dispensers accommodate cup needs from portion cup to large deli bowls
- Each EZ-Fit Cup Dispenser includes a pack of gaskets to handle a range of cup sizes



C2410C



C2210C



C2510C



C2010C



One-Size-Fits-All EZ-Fit®



Item	Rim Diameter	Cup Size	Counter Hole Diam.	Tube Length	Pack
C2410C	73-121 mm	236-1360 ml	146 mm	590 mm	6
C2410C16	73-121 mm	236-1360 ml	146 mm	406 mm	
C2410C18	73-121 mm	236-1360 ml	146 mm	457 mm	6
C2410CBK (Black Gasket)	73-121 mm	236-1360 ml	146 mm	590 mm	6

Construction: High-impact plastic

Note: For multiple in-counter units leave a 181 mm space between each unit.

Euro EZ-Fit®



Item	Rim Diameter	Cup Size	Counter Hole Diam.	Tube Length	Pack
C2210C	73-98 mm	178-710 ml)	124 mm	590 mm	6
C2210C18	73-98 mm	178-710 ml	124 mm	457 mm	6
C2210CBK (Black Gasket)	73-98 mm	178-710 ml	124 mm	590 mm	6

Construction: High-impact resistant plastic

Note: For multiple in-counter units leave a 159 mm space between each unit.

Large Deli Cup EZ-Fit®



Item	Rim Diameter	Cup Size	Counter Hole Diam.	Tube Length	Pack
C2510C	124-143 mm	950-1890 ml	168 mm	572 mm	1

Construction: High-impact resistant plastic

Note: For multiple in-counter units leave a 222 mm space between each unit.

Portion Cup EZ-Fit®

Item	Rim Diameter	Cup Size	Counter Hole Diam.	Tube Length	Pack
C2010C	38-59 mm	15-70 ml	83 mm	406 mm	6

Construction: High-impact resistant plastic

Note: For multiple in-counter units leave a 114 mm space between each unit.

EZ-Fit® Metal Finish Rings

Item	Description	Pack
C22XC	For C2210C (2 pk)	1 pk
C24XC	For C2410C (2 pk)	1 pk

EZ-Fit® Cup Dispenser Gaskets

Item	Description	Quantity	Pack
XC2426	C2410C EZ-Fit Dispenser Gaskets	Pack of 4 - S, M, L, XL	1
XC2426BK	C2410C EZ-Fit Dispenser Black Gaskets	Pack of 4 - S, M, L, XL	1
XC2226	C2210C Euro EZ-Fit Dispenser Gaskets	Pack of 4 - S, M, L, XL	1
XC2226BK	C2210C Euro EZ-Fit Dispenser Black Gaskets	Pack of 4 - S, M, L, XL	1
XC2526	C2510C Deli Cup Dispenser Gaskets	Pack of 3 - S, M, L	1
XC2022	C2010C Portion Cup Dispenser Gaskets	Pack of 4 - S, M, L, XL	1
C2400350	C2410C EZ-Fit Dispenser 3.5" Fixed Rim Insert	1 each	6
C2400363	C2410C EZ-Fit Dispenser 3.625" Fixed Rim Insert	1 each	6
C2400368	C2410C EZ-Fit Dispenser 3.68" Fixed Rim Insert	1 each	6
C2400413	C2410C EZ-Fit Dispenser 4.125" Fixed Rim Insert	1 each	6
C2400450	C2410C EZ-Fit Dispenser 4.5" Fixed Rim Insert	1 each	6

Half sized gaskets also available upon request.

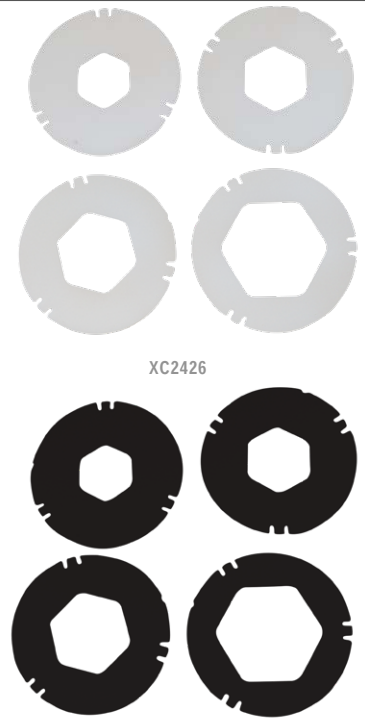

Surface-Mount EZ-Fit®

Item	Rim Diameter	Cup Size	Tube Length	Pack
C2210SM	73-98 mm	177-710 ml	457 mm	1
C2410SM	73-121 mm	236-1360 ml	590 mm	1

Construction: (Tube) high-impact plastic; (Wire Form) 6-gauge plated wire

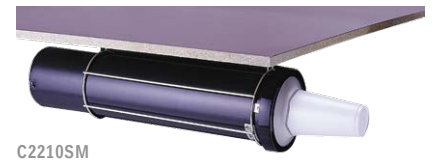

C2210SM



L2400C

EZ-Fit® In-Counter Lid Dispensers*

Item	Lid Rim Diameter	Cup Size	Counter Hole Diameter	Tube Length	Pack
L2200C	70-95 mm	236-710 ml	124 mm	603 mm	1
L2400C	95-114 mm	710-1360 ml	146 mm	603 mm	1

Construction: Impact resistant plastic

EZ-Fit® Lid Dispenser Cabinets*

Item	Includes	Dimensions	Pack
L2910BK	(1) L2200C; black trim ring	197 x 197 x 646 mm	1
L2920BK	(1) L2400C; black trim ring	197 x 197 x 646 mm	1
L2912BK	(1) L2200C, (1) L2400C; black trim rings	384 x 197 x 646 mm	1
L2913BK	(2) L2200C, (1) L2400C; black trim rings	568 x 197 x 646 mm	1
L2923BK	(1) L2200C, (2) L2400C; black trim rings	568 x 197 x 646 mm	1
L2913BK	(2) L2200C, (1) L2400C; black trim rings	568 x 197 x 646 mm	1

Construction: Black polystyrene



L2912BK

L2913BK

* EZ-Fit® Lid Dispensers are intended for use with flat, cold beverage lids only. May not be compatible with all lid types. To confirm lid compatibility, please provide a full sleeve of lids prior to ordering.

SENTRY® & EURO SENTRY® - ONE-SIZE-FITS-ALL CUP DISPENSERS

- Simple adjustment of levers for any cup: paper, foam or plastic
- Innovative contamination guard prevent debris from entering dispenser
- Food safety blue transparent tube allows for a last cleanliness check
- Levers prevent marring of cups and provide one-at-a-time dispensing

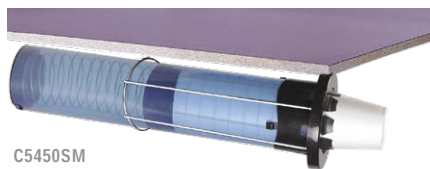

C5450SM

Sentry® Surface-Mount Adjustable Cup Dispenser **NSF**

Item	Rim Diameter	Cup Size	Tube Length	Pack
C5250SM	62-92 mm	118-710 ml	457 mm	1
C5450SM	79-114 mm	236-1301 ml	604 mm	1

Construction: (Tube) high-impact plastic; (Wire Form) 6-gauge plated wire



C5450C

Sentry® In-Counter Adjustable Cup Dispenser **NSF**

Item	Rim Diameter	Cup Size	Counter Hole Diam.	Tube Length	Pack
C5450C	79-114 mm	236-1301 ml	134 mm	597 mm	1
C5450C18	79-114 mm	236-1301 ml	134 mm	457 mm	1

Construction: High-impact plastic

Note: For multiple in-counter units leave a 7/4" (184 mm) space between each unit.



C5250C

Euro Sentry® In-Counter Adjustable Cup Dispenser **NSF**

Item	Rim Diameter	Cup Size	Counter Hole Diam.	Tube Length	Pack
C5250C	62-92 mm	118-710 ml	124 mm	597 mm	1
C5250C18	62-92 mm	118-710 ml	124 mm	457 mm	1

Construction: High-impact plastic

Note: For multiple in-counter units leave a 6/4" (159 mm) space between each unit.

SIZING CUPS & LIDS

SENTRY™

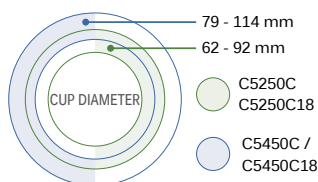

EZ-FIT®

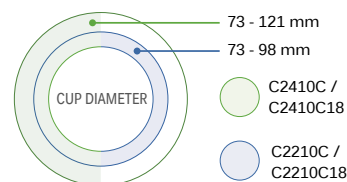

STAINLESS STEEL

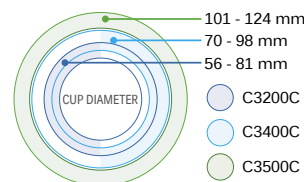

EZ-FIT® LID

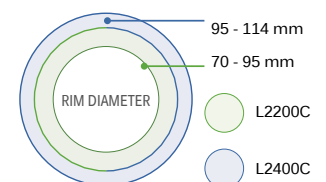

F - for foam cup mounted horizontally or vertically
H - for paper or plastic cup mounted horizontally
V - for paper or plastic cup mounted vertically or 45°
Example: C3400CH

Sentry® Beverage Dispenser Cabinets NSF

Item	Includes	Dimensions	Pack
C2951BK	(1) C5450C*; black trim ring	197 x 197 x 604 mm	1
C2952BK	(2) C5450C*; black trim rings	384 x 197 x 604 mm	1
C2953BK	(3) C5450C*; black trim rings	568 x 197 x 604 mm	1

Construction: Black polystyrene



Sentry® Stainless Steel Beverage Dispenser Cabinets NSF

Item	Includes	Dimensions	Pack
C2852	(2) C5450C*; black trim rings	406 x 206 x 619 mm	1
C2853	(3) C5450C*; black trim rings	616 x 206 x 619 mm	1
C2854	(4) C5450C*; black trim rings	768 x 206 x 619 mm	1

Construction: 22-gauge stainless steel



Sentry® Beverage & Lid Dispenser Cabinets NSF

Item	Includes	Dimensions	Pack
BEVERAGE, LID & STRAW CABINET			
L22CS2951BK	(1) C5450C*; (1) L2200C*; (1) straw compartment; black trim rings	568 x 197 x 645 mm	1
BEVERAGE & LID CABINETS			
L22C2951BK	(1) C5450C*; (1) L2200C*; black trim rings	384 x 197 x 645 mm	1
L24C2951BK	(1) C5450C*; (1) L2400C*; black trim rings	384 x 197 x 645 mm	1

Construction: Black polystyrene



Sentry® Metal Finish Rings

Item	Description	Pack
C52XC	For C5250C (2 pk)	1 pk
C54XC	For C5450C (2 pk)	1 pk





C8503WF
& X101924

C8504WFD shown
with C8500S
& X101924



C8500S



C8003WFS



C8005WFS

Wireworks™ Cup Dispenser & Lid Organizer



Item	Description	Dimensions	Pack
BASIC UNIT			
C8503WF	(2) cup dispensers, (1) lid organizer	492 x 162 x 464 mm	1
C8504WF	(3) cup dispensers, (1) lid organizer	620 x 162 x 464 mm	1
INCLUDES SIDE PANELS			
C8503WFD	(2) cup dispensers, (1) lid organizer, (2) side panels	492 x 162 x 464 mm	1
C8504WFD	(3) cup dispensers, (1) lid organizer, (2) side panels	620 x 162 x 464 mm	1
ACCESSORIES			
X101924	(1) Spindle for domed lids		1
X101987	(2) Spindle set for domed lids		1
C8500S	Straw organizer kit (cup and caddy)		1

Construction: Black epoxy-coated steel

Cup & Lid Wire Organizers

Item	Includes	Dimensions	Pack
C8003WF	3 stacks	216 x 350 x 133 mm	1
C8005WF	5 stacks	216 x 601 x 133 mm	1
C8003WFS	3 stacks, (1) straw caddy	216 x 445 x 133 mm	1
C8005WFS	5 stacks, (1) straw caddy	216 x 699 x 133 mm	1

Construction: 4 and 5 mm black epoxy-coated steel wire

Cup & Lid Dispenser Kit & Stand

Item	Includes	Description	Dimensions	Pack
C3620	Kit: C3604, L3402, C3200P, C3400P	Each stand will hold up to four San Jamar cup or lid dispensers in any configuration	914 x 305 x 305 mm	1
C3604	Stand only		Base: 254 mm diameter	1

Construction: (C3604) Chrome-plated steel; (C3200P, C3400P) 26-gauge stainless steel; (L3402) 22-gauge stainless steel



C3604

C3620

Lid Organizers

Item	Dimensions	Pack
L2100	279 x 318 x 419 mm	1
L2150	273 x 216 x 419 mm	1

Construction: 22-gauge 304-stainless with impact resistant plastic tray



L2100



L2150

Lid Towers

Item	Includes	Dimensions	Pack
L2202	(2) lid compartments (1) straw compartment	476 x 140 x 330 mm	1
L2203	(3) lid compartments (1) straw compartment	622 x 140 x 330 mm	1
L2204	(4) lid compartments (1) straw compartment	762 x 140 x 330 mm	1

Construction: Black polystyrene



L2202

L2203

L2204

Wall-Mount Lid Dispensers

Item	Capacity	Max Lid Rim Diameter	Cup Size	Tube Length	Pack
L3200	1 sleeve	89 mm	180-300 ml	597 mm	1
L3400	1 sleeve	101 mm	350-710 ml	597 mm	1
L3500	1 sleeve	127 mm	710-1360 ml	597 mm	1
L3402 double lid	1 sleeve	101 mm	350-710 ml	597 mm	1
L3502 double lid	1 sleeve	127 mm	710-1360 ml	597 mm	1

Construction: 22-gauge stainless steel



L3400

L3402

Large Trash Chute

Item	Diameter	Counter Hole Diameter	Tube Length	Pack
L360C	168 mm	152 mm	133 mm	1

Construction: 22-gauge stainless steel





PCL3ADJ



PCL2

Portion Cup & Lid Organizer **NEW**



Item	Lid/Rim Diameter	Dimensions	Pack
PCL2	50.8 mm	250 x 290 x 82 mm	1
PCL3ADJ	50.8 - 76.2 mm	250 x 290 x 95 mm	1



ST500

ST250



ST250WM

Bulk Straw Dispensers



Item	Description	Dimensions	Pack
ST500	Double-sided straw dispenser - 500 count	203 x 254 x 200 mm	1
ST250	Single-sided straw dispenser - 250 count	203 x 254 x 108 mm	1
ST250WM	Wall mounting bracket for use with ST250	171 x 273 x 127 mm	1



In-Counter Straw Dispenser

Item	Straw Rim Diameter	Counter Hole Diameter	Tube Length	Pack
L320C	136 mm	106 mm	152 mm	1

Construction: 22-gauge stainless steel



Venue[®] Coffee Sleeve Dispenser **NEW**



Item	Description	Dimensions	Pack
CSD100	For use with sleeves up to 63.5 mm H x 123.825 mm W	133 x 146 x 375 mm	1

Modular Organizer Series **NEW**  

Item	Description	Dimensions	Pack
MODL2900KIT	(1) Base unit, (2) shallow trays, (1) deep tray, (4) rubber linking feet	318 x 475 x 473 mm	1
MODL29001	Shallow tray: includes (3) dividers	69 x 148 x 432 mm	1
MODL29002	Deep tray: includes (1) divider	158 x 148 x 432 mm	1

Construction: High-impact plastic



MODL2900KIT



MODL29001



MODL29002





MODBD2002KIT

Modular Mini Dome® Series **NEW**  

- Can be used for dry or chilled condiments
- Interlocks with other Modular units

Item	Description	Dimensions	Pack
MODBD2002KIT	(1) Base unit, (1) Mini Dome insert, (4) BD2002, (4) rubber linking feet	318 x 475 x 473 mm	1
MODBD2002	Base unit, (1) Mini Dome insert, (4) rubber linking feet	318 x 475 x 473 mm	1
MODBD20021	Mini Dome insert	154 x 473 x 429 mm	1

Construction: High-impact plastic



MODMP16KIT

Modular ModPan™ Series **NEW**  

- Accommodates four 1/6 GN size pans
- Interlocks with other Modular units
- Fits Carlisle StorPlus™ & Coldmaster® food pans

Item	Description	Dimensions	Pack
MODMP16KIT	(1) Base unit, (1) ModPan insert, (4) MP16, (4) rubber linking feet	318 x 475 x 473 mm	1
MODMP16	Base unit, (1) ModPan insert, (4) rubber linking feet	318 x 475 x 473 mm	1
MODMP161	ModPan insert	32 x 473 x 429 mm	1

Construction: High-impact plastic



Modular Graphics Holder **NEW** 

- Easily adheres to the front of the Modular Organizer, Mini Dome or ModPan Series

Item	Description	Dimensions	Pack
MODGH100	Graphics and Promotion holder for MODL2900KIT, MODBD2002KIT, MODMP16KIT	432 x 107 mm	1



Modular Bulk FIFO Dispenser **NEW**  

- Top loading, bottom dispensing for first-in, first-out use
- Removable divider to allow horizontal plastic flatware dispensing

Item	Description	Dimensions	Pack
MODBFD	Modular bulk first-in, first-out dispenser	421 x 227 x 306 mm	1

Construction: High-impact plastic

Modular FrontLine™ Pump & Accessories **NEW** **NSF**

- Dispenses from gallon jar, #10 can, Cryovac® bag and direct pour
- Attachable drip tray keeps excess sauce off the countertop

Item	Description	Dimensions	Pack
MODP4900CL	Includes: P4900, MODCL100, MODBASE, MODTRAY	584 x 356 x 288 mm	1
MODP4900CC	Includes: P4900, MODCC100, MODBASE, MODTRAY	584 x 356 x 288 mm	1
MODCL100*	Modular Portion Cup & Lid Dispenser	366 x 153 x 286 mm	1
MODCC100	Modular Portion Cup Dispenser	320 x 153 x 286 mm	1
MODBASE	Modular FrontLine Pump Base	187 x 203 x 288 mm	1
MODTRAY	Modular FrontLine Pump Drip Tray	34 x 178 x 231 mm	1

MODCC100 & MODCL100 include a 4 pack of gaskets for each cup unit to handle a wide range of cup sizes
 *Portion Cup & Lid Dispensers are designed to work with cups and lids measuring 1.5" - 2.31" (38-59 mm) in rim diameter.

Cryovac® is a registered trademark of Cryovac, Inc., a subsidiary of Sealed Air Corporation
 Construction: High-impact plastic.



Modular Straw & Napkin Combo Dispensers **NEW** **NSF**

- Interchangeable lower dispensers to increase utility
- Smooth one-at-a-time napkin dispensing to reduce napkin waste

Item	Description	Napkin Type	Dimensions	Pack
MODH6003SN	Straw and Napkin Dispenser	Interfold	563 x 239 x 346 mm	1
MODH6003OGN	Organizer and Napkin Dispenser	Interfold	563 x 239 x 346 mm	1
MODH6005SN	Straw and Napkin Dispenser	Fullfold	563 x 239 x 347 mm	1
MODH6005OGN	Organizer and Napkin Dispenser	Fullfold	563 x 239 x 347 mm	1



Condiment & Straw Organizer **NSF**

Item	Dimensions	Pack
L2900	241 x 208 x 637 mm	1

Construction: Black polystyrene



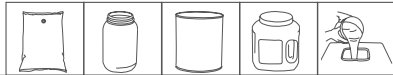

P/N	Cryovac® Bag	Gallon Jar	#10 Can	#10 Jar	Direct Pour
P4100	●	●	●	●	●
P4800		●	●	●	●
P4900	●	●	●	●	●

FRONTLINE™ CONDIMENT SYSTEMS

- Most versatile system on the market
- Sleek, low-profile design is durable and reliable
- Ensures smooth, effortless dispensing, and trouble-free maintenance



FrontLine™ Universal Countertop Box System



- Dispenses from liter jar, #10 can, Cryovac® bag and direct pour
- Soft-Touch™ pump delivers smooth, effortless dispensing

Item	Color	Dimensions	Pack
(1) PUMP BOX WITH TAMPER RESISTANT LID, PUMP, CONDIMENT LINER, CRYOVAC® BAG ADAPTER & PLUG, DIP TUBE.			
P4900	Metal Finish	without pump: 311 x 191 x 254 mm with pump: 546 x 191 x 318 mm	1
P4900BK	Black	without pump: 311 x 191 x 254 mm with pump: 546 x 191 x 318 mm	1

Construction: (Box/Lid) 22-gauge stainless steel
(Pump) High-impact plastic

FrontLine™ Universal In-Counter Condiment System



- Dispenses from liter jar, #10 can, Cryovac® bag and direct pour
- Soft-Touch™ pump delivers smooth, effortless dispensing



Item	Color	Counter Hole Diam.	Dimensions	Pack
(1) UNIVERSAL CONDIMENT DISPENSER WITH PUMP, TAMPER RESISTANT LID, IN-COUNTER LINER, CRYOVAC® BAG ADAPTER & PLUG, DIP TUBE.				
P4100	Metal Finish	216 x 165 mm	without pump: 305 x 191 x 241 mm above counter with pump: 248 x 191 x 241 mm	1
P4100BK	Black	216 x 165 mm	without pump: 305 x 191 x 241 mm above counter with pump: 248 x 191 x 241 mm	1

Construction: 22-gauge stainless steel; High-impact plastic

* Cryovac® is a registered trademark of Cryovac, Inc., a subsidiary of Sealed Air Corporation

In-Counter Napkin Dispensers

- Space-saving design for under the counter provides a neat, professional appearance
- Durable
- One-at-a-time dispensing of napkins

Item	Color	Type	Capacity	Dimensions	Pack
H2000*	XC, SS, SC, TBKSS	Minifold	750+	498 x 178 x 140 mm	1
H2000SS12	SS	Minifold	450+	349 x 178 x 140 mm	1
H2001*	XC, SS, CLSS, SC	Fullfold/Classic Face	750+	498 x 178 x 140 mm	1
H2001CLSS12	CLSS	Fullfold/Classic Face	450+	349 x 178 x 140 mm	1
H2001SS12	SS	Fullfold/Classic Face	450+	349 x 178 x 140 mm	1
H2005CLSS	CLSS	Fullfold/Control Face	750+	498 x 178 x 140 mm	1
H2003CLSS	CLSS	Interfold	750+	498 x 178 x 140 mm	1
H2003CLSS12	CLSS	Interfold	450+	349 x 178 x 140 mm	1

* Specify desired color after item number.
 Construction: (Face) 18-gauge steel and ABS plastic; (Body) 22-gauge stainless steel

Code	Face	Body
XC	Chrome	Chrome
CLSS	Clear	Stainless Steel
SS	Stainless Steel	Stainless Steel
SC	Satin Chrome	Satin Chrome
TBKSS	Black Pearl	Stainless Steel

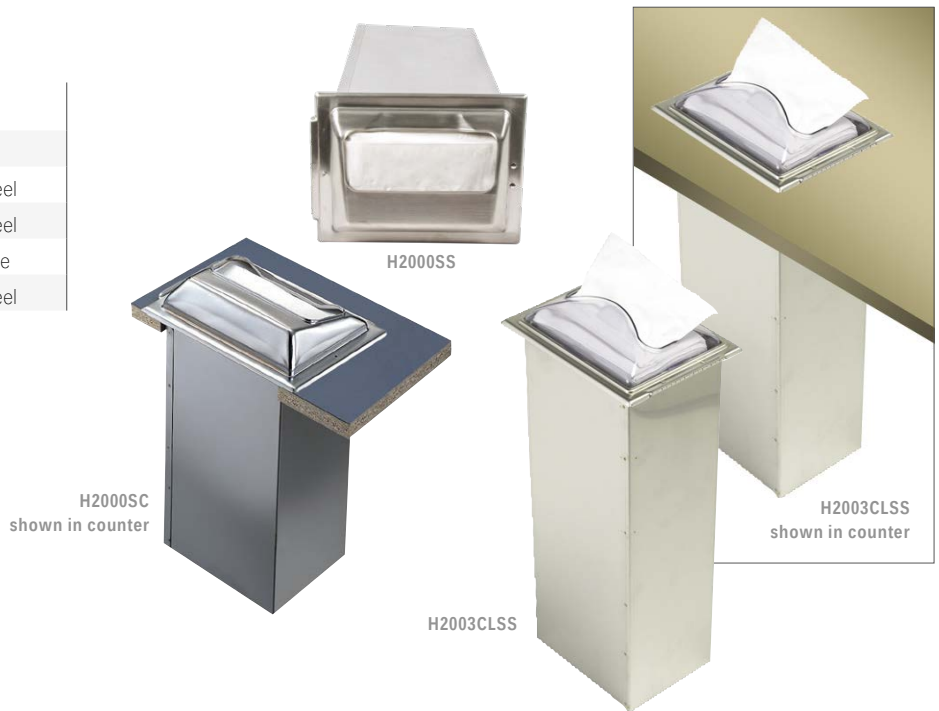

FULLFOLD & MINIFOLD



CONTROL FACE

INTERFOLD



INTERFOLD FACE

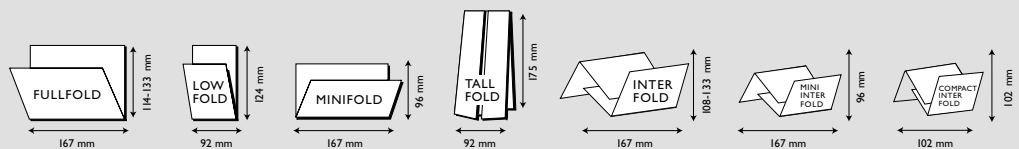

NAPKIN FACEPLATE OPTIONS

NAPKIN FOLDS AND SIZES

Venue® Tabletop Napkin Dispenser



- Includes advertising insert space for in-house promotion
- Available with or without caddy
- Compact design

Item	Color	Type	Capacity	Dimensions	Pack
H4000TBK	Black Pearl	Minifold	200+	124 x 191 x 159 mm	1
H4003TBK	Black Pearl	Interfold	200+	159 x 191 x 156 mm	4
H4004TBK	Black Pearl	Mini Interfold	200+	124 x 191 x 159 mm	6
H4005TBK	Black Pearl	Fullfold/Control face	200+	159 x 191 x 156 mm	4
H4006TBK	Black Pearl	Compact Interfold	200+	161 x 130 x 132 mm	4
H4005CTBK	Black Pearl	Fullfold Dispenser & Caddy	200+	159 x 362 x 156 mm	24
H400CTBK	Black Pearl	Caddy only	N/A	70 x 362 x 156 mm	1

Construction: Impact resistant plastic



Venue® Countertop Napkin Dispenser



- Stackable design to save counter space
- One-at-a-time dispensing to save napkin waste
- Smooth dispensing down to the last napkin

Item	Color	Type	Capacity	Dimensions	Pack
H5000*	CL (Clear), TBK (Black Pearl)	Minifold/Control Face	450+	156 x 203 x 400 mm	1
H5003*	CL (Clear), TBK (Black Pearl)	Interfold	450+	181 x 203 x 400 mm	1
H5004*	CL (Clear), TBK (Black Pearl)	Mini Interfold	450+	149 x 203 x 400 mm	1
H5005*	CL (Clear), TBK (Black Pearl)	Fullfold/Control Face	450+	181 x 203 x 400 mm	1

* Specify desired color after item number.
Construction: Impact resistant plastic

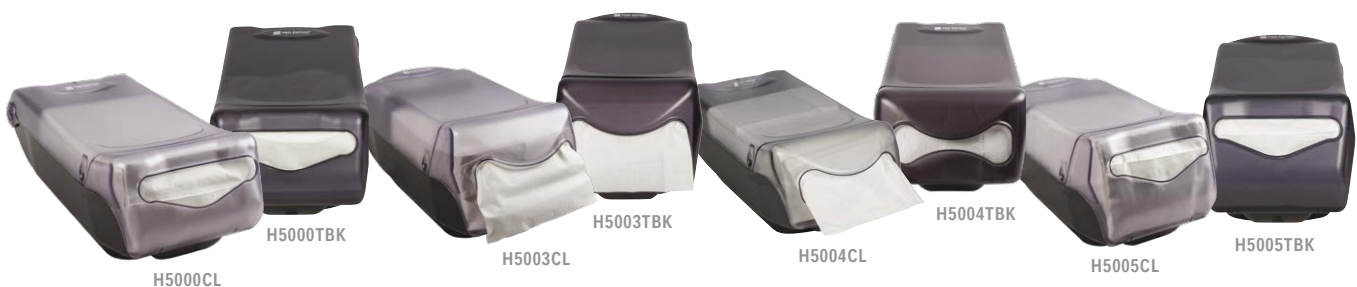

Venue® Napkin Dispenser with Stand NSF

- Stand model enhances image and saves counter space
- One-at-a-time dispensing to save napkin waste
- Smooth dispensing down to the last napkin

Item	Color	Type	Capacity	Dimensions	Pack
H5000SCL	Clear	Minifold/Control Face	450+	440 x 203 x 330 mm	1
H5000STBK	Black Pearl	Minifold/Control Face	450+	440 x 203 x 330 mm	1
H5005SCL	Clear	Fullfold/Control Face	450+	441 x 203 x 330 mm	1
H5005STBK	Black Pearl	Fullfold/Control Face	450+	441 x 203 x 330 mm	1

Construction: Impact resistant plastic



Venue® Wall Model Napkin Dispenser NSF

- Mount to the wall to save valuable counter space
- One-at-a-time dispensing to save napkin waste
- Smooth dispensing down to the last napkin

Item	Color	Type	Capacity	Dimensions	Pack
H5000PCL	Clear	Minifold/Control Face	500+	400 x 203 x 156 mm	1
H5000PTBK	Black Pearl	Minifold/Control Face	500+	400 x 203 x 156 mm	1
H5003PCL	Clear	Interfold	500+	400 x 203 x 181 mm	1
H5003PTBK	Black Pearl	Interfold	500+	400 x 203 x 181 mm	1
H5004PCL	Clear	Mini Interfold	500+	400 x 203 x 149 mm	1
H5004PTBK	Black Pearl	Mini Interfold	500+	400 x 203 x 149 mm	1
H5005PCL	Clear	Fullfold/Control Face	500+	400 x 203 x 181 mm	1
H5005PTBK	Black Pearl	Fullfold/Control Face	500+	400 x 203 x 181 mm	1

Construction: Impact resistant plastic





 **san jamar**[®]
smart. safe. sanitary.



FOOD SAFETY TOOLS

SAF-T-GRIP® CUTTING BOARDS

- Integrated anti-slip grips securely hold board in place
- Patented Food Safety Hook for sanitary transport and storage
- Durable co-polymer material will not warp

Saf-T-Grip Cutting Boards

Item	Color	Dimensions	Pack
CBG121812*	BL (Blue), BR (Brown), GN (Green), RD (Red), WH (White), YL (Yellow)	305 x 457 x 13 mm	6
CBG152012*		381 x 508 x 13 mm	6
CBG182412*		457 x 610 x 13 mm	6



Saf-T-Grip White Cutting Boards

Item	Color	Dimensions	Pack
CBGW912*	BL (Blue), GN (Green), RD (Red), YL (Yellow)	229 x 305 x 9.5 mm	6
CBGW152012*		381 x 508 x 13 mm	6



Saf-T-Grip White 4-Board System

Item	Description	Dimensions	Pack
CBGW912QS	4-Board System: (1ea) White board with blue, green, red, and yellow Saf-T-Grips®	229 x 305 x 9.5 mm	1 system
CBGW152012QS		381 x 508 x 13 mm	1 system



CUT-N-CARRY® CUTTING BOARDS

- Patented Food Safety Hook design for sanitary transport and storage
- Durable co-polymer construction provides superior heat, chemical and warp resistance
- Materials won't dull knives and resists unsanitary cut-grooving

Cut-N-Carry Color Cutting Boards

Item	Color	Dimensions	Pack
CB101212*	GN (Green), YL (Yellow)	254 x 305 x 13 mm	6
CB121812*	BL (Blue), BR (Brown), GN (Green), RD (Red), WH (White), YL (Yellow)	305 x 457 x 13 mm	6
CB152012*		381 x 508 x 13 mm	6
CB182412*		457 x 610 x 13 mm	6
CB121834*		305 x 457 x 19 mm	4
CB182434*		457 x 610 x 19 mm	4



Cut-N-Carry 4 & 6-Board Systems

Item	Description	Dimensions	Pack
CB1218QS	4-Board System: (1ea) green, red, white, and yellow cutting board	305 x 457 x 13 mm	1 system
CB1520QS		381 x 508 x 13 mm	1 system
CB1824QS		457 x 610 x 13 mm	1 system
CB1218KC	6-Board System: (1ea) blue, brown, green, red, white and yellow cutting board	305 x 457 x 13 mm	1 system
CB1520KC		381 x 508 x 13 mm	1 system
CB1824KC		457 x 610 x 13 mm	1 system



4-Board Cut-N-Carry® System

TUFF-CUT® CUTTING BOARDS

- Designed for high-heat applications
- Rated to withstand temperatures up to 177°C without warping or scorching
- Ideal for use as pizza peels and meat carving

Tuff-Cut Cutting Boards

Item	Description	Dimensions	Pack
TC121812	Regular cutting board	305 x 457 x 13 mm	6
TC152012	Regular cutting board	381 x 508 x 13 mm	6
TC182412	Regular cutting board	457 x 610 x 13 mm	6
TC121812GV	Grooved cutting board	305 x 457 x 13 mm	6
TC152012GV	Grooved cutting board	381 x 508 x 13 mm	6
TC182412GV	Grooved cutting board	457 x 610 x 13 mm	6



Regular

Grooved

Tuff-Cut Bread Boards

Item	Description	Dimensions	Pack
TC7501	Bread board with 127 mm handle	178 x 229 x 6 mm)	12
TC7502	Bread board with 152 mm handle	178 x 229 x 13 mm)	12
TC7503	Bread board with 102 mm handle & butter well	216 x 165 x 19 mm	12



TC7501

TC7502

TC7503



Sparta® Spectrum® Cutting Board Brushes **NEW**

- Color-coded to prevent cross-contamination
- Ergonomic handles provide comfortable grip
- 4-Pack

Item	Color	Dimensions	Pack
CBB6*	Blue (BL), Brown (BR), Green (GN), Red (RD), Yellow (YL), White (WH), Purple (PR)	152 x 50.8 mm Bristle Length: 35 mm	1
CBB6MC	4 pack: (1 ea) RD, YL, BL, GN	152 x 50.8 mm Bristle Length: 35 mm	1

* Specify desired color after item number. Example: CBB6BL



Saf-T-Grip® Board Mate®

- Replaces unsanitary "wet towel" to keep non-grip boards from shifting and sliding
- Reduces knife accidents and injuries during prep
- Also keeps countertop appliances from slipping

Item	Dimensions	Pack
CBM1016	254 x 406 mm	6
CBM1318	330 x 457 mm	6
CBM1622	406 x 559 mm	6

Cutting Board Accessories

Item	Description	Pack
KLRST	Cutting board storage stand with non-slip feet	12
CNCRK	Shelf-mounting hanging rack	12
CBCWLCTST	Color-coded cutting board smart chart / 6-board with stickers	12
QSWLCT	Color-coded cutting board smart chart / 4-board	1
1178902	Cutting Board Refinisher	1
1179944	Replacement Finisher Blades (2 Pk)	1



1178902



CUSTOMIZABLE CUTTING BOARD COLOR CODING CHART
 COORDONATE DE COULEUR POUR PRÉVENIR LA CONTAMINATION
 GUIDE DE SÉLECTION COULEUR (RÉDACTÉ) - ALPHABÉTIQUE

STEPS TO SANITARY
 1. Assign color-coded cutting board & attach to specific tasks to help prevent cross-contamination
 2. Wash & sanitize hands before handling food
 3. If you are using a cutting board, use a separate cutting board for each food type
 4. Wash & sanitize cutting board after each use

STEPS TO SANITARY FOOD PREP:
 1. Wash, rinse & sanitize all work surfaces, equipment & utensils after each use. Use a separate cutting board for each food type.
 2. Wash & sanitize hands before handling food.
 3. Wash, rinse & sanitize all work surfaces, equipment & utensils after each use. Use a separate cutting board for each food type.
 4. Place cut foods in washed and sanitized containers & store properly.
 5. Wash & sanitize cutting board after each use.

FOOD CATEGORIES:
 MEAT (RED), FISH & SEAFOOD (ORANGE), POULTRY (BROWN), COOKED FOODS (GREEN), DAIRY PRODUCTS (WHITE), Fruits & Vegetables (YELLOW), ALLERGEN SAF-T-Grip (PINK)



KLRST



CNCRK

Allergen Saf-T-Zone™ Cutting Boards

- Purple color alerts staff to follow special procedures
- Durable co-polymer material will not warp
- Integrated anti-slip grip securely holds board in place

Item	Dimensions	Pack
CBG6938PR	152 x 229 x 9.5 mm	6
CBG912PR	229 x 305 x 9.5 mm	6
CBG121812PR	305 x 457 x 13 mm	6
CBG152012PR	381 x 508 x 13 mm	6



Allergen Saf-T-Zone™ Mats

- Easily identify allergen preparation is being done
- Top 8 allergens are identified on the mat to aid in employee allergen awareness
- 304 mm mat can be used as designated allergen area for food holding

Item	Includes	Dimensions	Pack
CBMASZ1212	Server window Allergen Saf-T-Zone Mat	304 x 304 mm	1
CBMASZ2430	Prep station Allergen-Saf-T-Zone Mat	609 x 762 mm	1



Allergen Saf-T-Zone™ System

- Purple color alerts staff to follow special food allergy procedures
- Includes commercial-grade cutting board, tongs, turner and Chef's knife
- Durable purple case is easy to find in the kitchen and securely protects tools and board



ASZ121812SYS

Item	Includes	Pack
ASZ121812SYS	(1) Saf-T-Grip purple cutting board (CBG121812PR) 305 x 457 x 13 mm (1) Stainless steel chef knife with purple handle 254 mm (1) Stainless steel tongs with purple handle 305 mm (1) Stainless steel turner with purple handle 330 mm (Thermometer not included)	1 System
ASZTHERMW	Professional digital thermometer with protective sheath, dishwasher safe	1



Allergen Saf-T-Zone™
Cutting Board
CBG121812PR



305 mm Tongs
ASZTONGS



330 mm Turner
ASZTURNER



254 mm
Chef Knife
ASZKNIFE

Thermometer sold separately



ASZTHERMW

SAF-T-WRAP® STATION



- Saves money by reducing labeling time and minimizing food waste by aiding in FIFO food rotation
- Dispenses dating labels in multiple sizes and configurations
- Available with safety blade for film, foil and paper—or slide cutter for one-handed film dispensing

Item	Description	Capacity	Core Diameter	Pack
SW1218	Saf-T-Wrap Station with Safety Blade (for film, foil or paper)	Accepts date label rolls from 1.9-7.6 cm wide; 8.25 cm diameter. Dispenses Film/Foil/Paper rolls from 30.48-42.75 cm, 12.95 cm total diameter	Min. 30 mm	1
SW1218SC	Saf-T-Wrap Station with Slide Cutter (for film)	Accepts date label rolls from 1.9-7.6 cm wide; 8.25 cm diameter. Dispenses Film rolls from 30.48-42.75 cm, 12.95 cm total diameter	Min. 30 mm	1



SW1218SC



SW1218SC
Close Up of Slide Cutter



SW1218

SAF-T-WRAP® 305 & 457 MM



- Accommodates film or foil rolls and saves time while minimizing waste
- Includes safety blade and slide cutter for easy cutting of film, foil and paper
- Film and foil rolls are fully enclosed and protected preventing cross-contamination from unsanitary cardboard cutter boxes
- Economical by utilizing entire roll and keeping your film/foil in a durable, protected dispenser; resulting in substantial cost savings

Item	Description	Capacity	Pack
SW12	Saf-T-Wrap with Slide Cutter and optional Safety Blade (for film or foil)	Dispense Film/Foil rolls from 305 mm	1
SW18	Saf-T-Wrap with Slide Cutter and optional Safety Blade (for film or foil)	Dispense Film/Foil rolls from 381 mm - 457 mm	1
SWX100	Saf-T-Wrap Stackers (2) Brackets (8) Wing Nuts	Stackers can hold (2) SW12, (2) SW18 or (1) SW12 and (1) SW18	1



SW12



SW18



SW12, SW18 Shown Using SWX100

Saf-T-Label™ Dispenser **NSF**

- Easily separates labels from backing paper
- Integrated brackets to hang on wire shelving or wall-mount brackets

Item	Capacity	Dimensions H x W x D	Pack
STL511	Accepts date label rolls from 1.91-5.08 cm wide; 8.26 cm diameter	178 mm x 507 mm x 130 mm	1



Rapi-Kool® Plus Cold Paddles **NSF**

- Wide opening allows for on-demand use by filling with ice and water
- Patented Fill-Rite™ design eliminates over-filling when pre-freezing
- Integrated hanging hook for sanitary and secure storage

Item	Description	Pack
RCU64V2	Rapi-Kool Plus - 1.9 L	1
RCU128V2	Rapi-Kool Plus - 3.8 L	1



RCU128V2

RCU64V2

Kleen-Cup®

- Effectively cleans and sanitizes mixer spindles, replaceable brushes
- Prevents flavor transfer and cross-contamination

Item	Description	Dimensions H x D	Pack
KLC28C	(1) Kleen-Cup spindle sanitizer	197 x 102 mm	1



Saf-T-Knife® Station **NSF**

- Sanitary, safe and secure storage for kitchen knives
- Protects knives from contamination and accidents
- Easy to assemble and clean

Item	Dimensions H x W x D	Pack
STK1008	381 x 381 x 108 mm	1



*Knives not included

Saf-T-Knife® Station Jr. **NSF**

- Color-coded lids designed to keep track of which knife is used for what purpose
- Perfect size for prep lines and smaller kitchens

Item	Description	Dimensions H x W x D	Pack
STK1006	Saf-T-Knife Station Jr.	368 x 211 x 102 mm	1
STK1006RDL	Saf-T-Knife Station Jr. - Red (Lid Only)	48 x 203 x 102 mm	1
STK1006GRL	Saf-T-Knife Station Jr. - Green (Lid Only)	48 x 203 x 102 mm	1
STK1006YLL	Saf-T-Knife Station Jr. - Yellow (Lid Only)	48 x 203 x 102 mm	1
STK1006PRL	Saf-T-Knife Station Jr. - Purple (Lid Only)	48 x 203 x 102 mm	1



STK1006

*Knives not included



STK1006RDL



STK1006GRL



STK1006YLL



STK1006PRL

PAILS

- Kleen-Pail, the original dedicated non-food container for safe foodservice cleaning and sanitation
- Available in multiple sizes for front or back-of-the house
- Durable, robust handle design



PAIL USAGE GUIDE

- Sanitizer
- Detergent (Cleaner)
- } Blank space for labeling purposes
- }
- Broken Glass Only
- Allergen
- Janitorial

Kleen-Pail®

- Color-coded pails for use with detergent and sanitizer
- New embossed feature designed to meet health code
- Trilingual design aids in training

Item	Color	Description	Pack
KP97*	RD (Red), GN (Green)	2.84 L	12
KP196*	RD (Red), GN (Green) PR (Purple)	5.68 L	12
KP256*	RD (Red), GN (Green)	7.57 L	12
KP320*	RD (Red), GN (Green), BL (Blue), YL (Yellow), GR (Grey)	9.46 L	12
KP320WH	White	9.46 L	
KLEEN-COLOR PAILS			
KP196KCBL	Blue	5.68 L	12
KP196KCYL	Yellow	5.68 L	12
KP196KCRD	Red	5.68 L	12
KP196KCGN	Green	5.68 L	12

* Specify desired color after item number. Example: KP97GN



Kleen-Pail® Stands*

- Allows you to move Sanitizer and Detergent Pails off of the floor or work surface
- Provides a sanitary storage holder for KP196* and KP97*

Item	Description	Pack
KPS196	Kleen-Pail stand holds KP196	1
KPS97	Kleen-Pail stand holds KP97	1
KPS196WM	Kleen-Pail wall mount stand holds KP196	1
KPS97WM	Kleen-Pail wall mount stand holds KP97	1
KPS256WM	Kleen-Pail wall mount stand holds KP256	1

* Kleen-Pail sold separately

Kleen-Pail® Pro   **NEW**

- Color-coded, trilingual pails for use with detergent or sanitizer
- Curved shape and raised bottom for easy pouring
- Molded-in handles with embossed, raised lettering to meet health code
- Built-in debris-catching ribs

Item	Color	Description	Pack
KPP97RD	Red	2.84 L	12
KPP97GN	Green	2.84 L	12
KPP196RD	Red	5.68 L	12
KPP196GN	Green	5.68 L	12
KPP256RD	Red	7.57 L	12
KPP256GN	Green	7.57 L	12



Kleen-Pail® Pro Stands* **NEW**

- Allows you to move Sanitizer and Detergent Pails off of the floor or work surface
- Provides a sanitary storage holder for KPP97*, KPP196*, and KPP256*.

Item	Description	Pack
KPPS97	Kleen-Pail stand holds KPP97	12
KPPS97WM	Kleen-Pail wall mount stand holds KPP97	12
KPPS196	Kleen-Pail stand holds KPP196	12
KPPS196WM	Kleen-Pail wall mount stand holds KPP196	12
KPPS256	Kleen-Pail stand holds KPP256	12
KPPS256WM	Kleen-Pail wall mount stand holds KPP256	12



KPPS196WM

*Kleen-Pail Pro sold separately.

TOTES

- The original dedicated Saf-T-Ice Tote is designed to make ice transport easier and safer than traditional “buckets”
- Unique patented features and accessories



Original & Shorty™ Saf-T-Ice® Tote

- Dedicated container for safe ice transport
- HACCP Hanger™ reduces back strain and injuries
- Tri-grip™ design for easier, more controlled handling

Item	Description	Capacity	Pack
SI6000	Original Saf-T-Ice Tote	22.7 L	2
SI6100	Shorty Saf-T-Ice Tote	18.9 L	2
SI6150BPAF	BPA FREE Shorty Saf-T-Ice Tote and Lid	18.9 L	1
SI6500	Saf-T-Ice Lid (Fits Original & Shorty)	N/A	1

Saf-T-Ice® Cart

- Cart transport system for use with (2) Saf-T-Ice® SI6000 or (2) SI6100
- Avoid costly work injuries; doubles productivity
- Folds for easy storage

Item	Description	Pack
SICART60	Cart transportation system for use with (2) SI6000 Saf-T-Ice Totes (Totes sold separately)	1
SICART61	Cart transportation system for use with (2) SI6100 Saf-T-Ice Totes (Totes sold separately)	1
X102273	Top Lid	1
X102268	Mid Support Lid	1



SICART60

Light Duty™ Ice Tote

- Economical, easy and safe way to transport ice
- Attaches to ice bin for faster and easier filling
- Dual-grip design provides secure handling options for improved ergonomics

Item	Description	Pack
SILD6000	Holds up to 22.7 L of ice	1



SCOOPS & HOLDERS

- Saf-T-Scoop® and Guardian™ Systems provide a safe and sanitary way to serve ice
- Available for the bar, beverage station or ice machine
- Dual Germ-Guards™ protect ice from hand contamination
- Guardian™ Scoop holder encloses and protects scoop from splash-up contamination

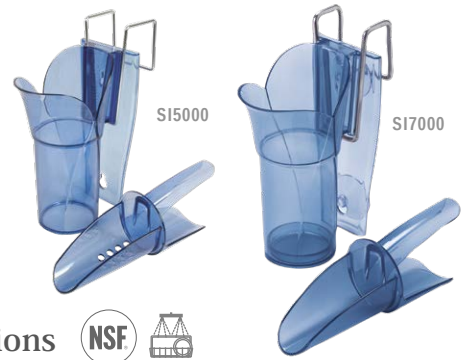

Saf-T-Scoop® & Guardian™ System for Bar & Beverage Stations



Item	Description	Pack
SI5000	Scoop Guardian System 177-295 ml (1) Saf-T-Scoop, (1) Guardian holder with removable drainage cap, (1) set mounting tools	1
SI5500	Saf-T-Scoop 177-295 ml (scoop only)	1
SI7000	Scoop Guardian System 355-473 ml (1) Saf-T-Scoop, (1) Guardian holder with removable drainage cap, (1) set mounting tools	1
SI7500	Saf-T-Scoop 355-473 ml (scoop only)	1

BPA FREE - Saf-T-Scoop® & Guardian™ System for Bar & Beverage Stations



Item	Description	Pack
SI5000EUR	Scoop Guardian System 177-295 ml (1) Saf-T-Scoop, (1) Guardian holder with removable drainage cap, (1) set mounting tools	1
SI5500EUR	Saf-T-Scoop 177-295 ml (scoop only)	1
SI7000EUR	Scoop Guardian System 355-473 ml (1) Saf-T-Scoop, (1) Guardian holder with removable drainage cap, (1) set mounting tools	1
SI7500EUR	Saf-T-Scoop 355-473 ml (scoop only)	1

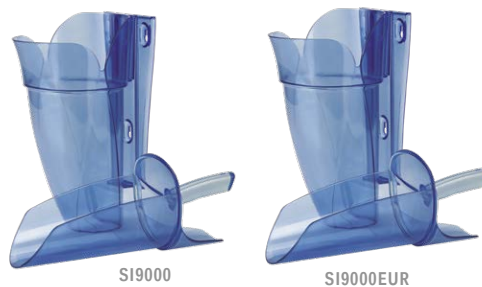

Saf-T-Scoop® & Guardian™ System for Ice Machines



Item	Description	Pack
SI9000	Scoop Guardian System 1.9-2.5 L (1) Saf-T-Scoop, (1) Guardian holder with removable drainage cap, (1) set mounting tools	1
SI9500	Saf-T-Scoop 1.9-2.5 L (scoop only)	1

BPA FREE - Saf-T-Scoop® & Guardian™ System for Ice Machines



SI9000EUR	Scoop Guardian System 1.9-2.5 L (1) Saf-T-Scoop, (1) Guardian holder with removable drainage cap, (1) set mounting tools	1
SI9500EUR	Saf-T-Scoop 1.9-2.5 L (scoop only)	1

Saf-T-Scoop® Alarm Monitoring System

- Alarm prevents prolonged scoop displacement
- Adjustable sound levels
- Dual germ guards protect against contamination



Item	Description	Pack
SI9000SAM	(1) Alarm Module, (1) Scoop & Guardian System 1.9-2.5 L, (1) Saf-T-Scoop®, (1) guardian holder with removable drainage cap, (1) set mounting tools	1

Alarm only works with SI9000SAM

Adjustable Saf-T-Scoop®

- Designed for iced drink applications and beverage stations
- Eliminate multiple sizes of scoops
- Dispenses 29.5 ml, 473 ml and 709 ml of ice to multiple sizes of cups

Item	Description	Pack
SI7800	Adjustable Scoop and Guardian System 264-710 ml (1) Adjustable Saf-T-Ice Scoop, (1) Guardian holder with removable drainage cap, (1) set mounting tools (1 mounting bracket, 2 wire hanging brackets and 2 suction cups)	1
SI7850	Adjustable Scoop 264-710 ml (scoop only)	1

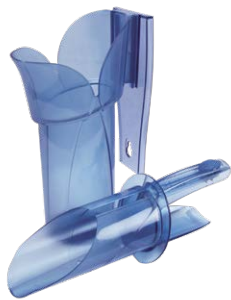

SI7800



SI7800



SI7850

Banquet/Beverage Saf-T-Scoop®

- Germ-Guards™ protect ice from contact with hands
- Drain holes prevent watering down of beverages
- Built in hook prevents cross contamination; stores neatly on side of bin

Item	Description	Pack
SI4550	Saf-T-Scoop 118-177 ml (scoop only)	1







BAR AND FOOD MANAGEMENT

THE DOME® AND MINI DOME®

- Patented, domed lid rotates back for easy access and increased capacity when closed; notched lid option
- Use standard size trays to keep food chilled or deep trays for extra capacity
- Optional connectors provide modularity between Mini Dome, Dome and snap-on caddies

THE DOME® DIMENSIONS

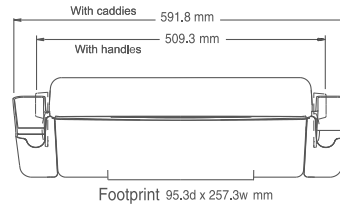

MINI DOME® DIMENSIONS

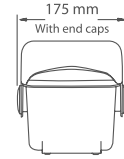

The Dome Garnish Centers

Item	Description	Capacity	Pack
BD4005S	(1) 1.9 L deep tray; (4) 0.47 L standard trays; (2) snap-on caddies, handles	3.8 L	1
BD4005E	(1) 1.9 L deep tray; (4) 0.47 L standard trays; (2) end caps; (1) snap-on caddy	3.8 L	1
BD4023S	(2) 2.9 L deep trays; (3) 0.47 L standard trays; (2) snap-on caddies, handles	4.25 L	1
BD4006S	(6) 0.47 L standard trays; (2) snap-on caddies, handles	2.8 L	1
BD4003	(3) 1.9 L quart deep trays; (2) handles	5.6 L	1
BD4004	(4) 2.9 L deep trays; (2) handles	5.6 L	1
BD4014	(4) 0.71 L standard trays; (2) handles	2.8 L	1

Construction: High-impact plastic
Insert Trays are BPA Free



BD4005E



BD4006S



BD4004



BD4003

Mini Dome® Garnish Centers

Item	Description	Capacity	Pack
EACH MINI DOME COMES WITH (2) END CAPS			
BD2001	(1) 1.9 L deep tray	1.9 L	1
BD2002	(1) 0.95 L standard tray	0.95 L	1
BD2003	(2) 0.47 L standard trays	0.47 L	1
BD2004NL	(2) 0.71 L deep trays (notched domed lid)	1.4 L	1
BD2002CAR	(1) 1 qt. (0.95 L) standard tray (with caddy)	0.95 L	1
BD2004CAL	(2) 1.5 pt. (0.71 L) deep trays (with left hand caddy)	3 pt. (1.4 L)	1



Construction: High-impact plastic



Dome® Stacker

- Allows you to customize a configuration using Dome and Mini Dome to fit virtually any space
- Makes your operation more efficient, more organized and more professional

Item	Description	Capacity	Pack
BDSX100	Dome Stacker Conversion Kit - converts your Dome or Mini Dome into a versatile, organized garnish center (Dome and Mini Dome not included)	N/A	1
BDS2203	Dome Stacker - 1/1 Mini Dome: (4) .47 L trays & bonus (2) 1.8 L trays	3.8 L	1
BDS2204NL	Dome Stacker - 1/1 Mini Dome: (4) .7 L deep trays - notched lids & bonus (2) 1.8 L trays	4.25 L	1
BDS2401NL	Dome Stacker - 2/2 Mini Domes: (4) 1.8 L deep Trays	2.8 L	1
BDS2483NL	Dome Stacker - 2/2 Mini Domes: (4) .7 L deep trays, (4) .47 L standard trays, (2) notched lids & (2) standard lids	5.6 L	1
BDS4206	Dome Stacker - 1/1 Dome: (12) .47 L standard trays	5.6 L	1
BDS4266	Dome Stacker - 1/1 Dome: (3) 1.8 L deep trays, (6) .47 L standard trays (chillable)	2.8 L	1

Construction: High-impact plastic





Shown with Dome Garnish Center and cutting board, not included

The Dome® Glass Rimming Station



- Comprehensive bar management system
- Promotes all-in-one station for serving beverages/cocktails
- Allows for storage of bar board and paring knife

Item	Description	Pack
BDRX400	Rimming Station to be used with The Dome Garnish Centers Includes (3) 127 mm round trays, (1) 102 mm round tray and (1) sponge for 127 mm tray	1

Construction: High-impact plastic
Insert Trays & Rimming Station are BPA Free



The Dome® & Mini Dome® Replacements



- Choose from a wide variety of tray configurations; chillable and non-chillable
- Snap-on caddies and connectors available for maximum flexibility

Item	Description	Pack
BD100S	Snap-on caddies	2
BD101	0.47 L standard tray - chillable	12
BD102	0.71 L standard tray - chillable - for Dome only	6
BD103	1.4 L deep tray - for Dome® only	6
BD104	1.9 L deep tray	6
BD105	0.71 L deep tray	6
BD106	0.95 L standard tray - chillable	6
BD110	Connector	1

Construction: High-impact plastic

Versa-Mat®



- Versatile interlocking mats to line shelves and sinks
- Design allows for sanitary airflow under glassware
- Flexible and easy to cut to any shape or size

Item	Color	Description	Dimensions H x W	Pack
VM5280*	BK, CL, RD, WN	Interlocking Bar Matting	305 x 305 mm	24
VM5280*-12	BK, CL, RD, WN	Interlocking Bar Matting 12 pk	305 x 305 mm	1

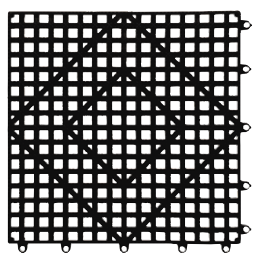

VM5280BK

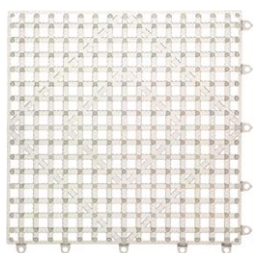

VM5280CL

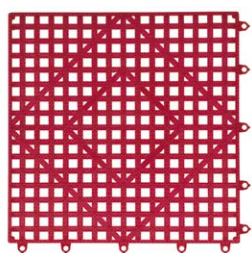

VM5280RD

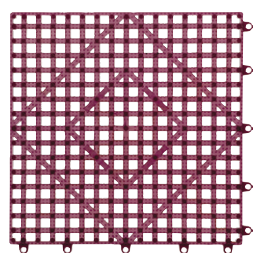

VM5280WN

ModPans™



- ModPans™ include friction fit lids that keep food safe, eliminating the need for wrapping pans with messy plastic wrap or aluminum foil
- Fits in standard make/prep tables – direct from refrigerator to table
- Made of odor and stain resistant transparent polypropylene in Gastronorm sizes, as specified in the EN 631 standards, available in .95 liter, 1.9 liter, 3.8 liter, and 8.6 liter pans
- Microwave safe

Item	Description	Capacity	Pack
MP19	1/9 food pan with lid - 384 mm deep	.95 L	1 Pk (12 per Pk)
MP16	1/6 food pan with lid - 105 mm deep	1.9 L	1 Pk (12 per Pk)
MP14	1/4 food pan with lid - 165 mm deep	3.8 L	1 Pk (12 per Pk)
MP13	1/3 food pan with lid - 140 mm deep	3.8 L	1 Pk (12 per Pk)
MP12	1/2 food pan with lid - 152 mm deep	8.6 L	1 Pk (12 per Pk)
ALLERGEN LID ONLY			
MPL19PR	1/9 purple lid only		1 Pk (6 per Pk)
MPL16PR	1/6 purple lid only		1 Pk (6 per Pk)
MPL14PR	1/4 purple lid only		1 Pk (6 per Pk)
MPL13PR	1/3 purple lid only		1 Pk (6 per Pk)
MPL12PR	1/2 purple lid only		1 Pk (6 per Pk)



Construction: Polypropylene



Kleen Plug™



- Protects beer taps and bottles from fruit flies and other contaminants
- Affordable and easy-to-use
- Also seals and protects beverage station drains

Item	Description	Quantity	Pack
KLP200	Kleen Plug Blister Pack	5	1
KLP250	Bulk Kleen Plugs	50	1

Construction: High-impact plastic



KLP200

Insulated Food Carriers

- Features outside identity pocket
- Comfortable padded handles
- Zipper closure



FC1212-RD



FC2212-RD

Item	Dimensions	Pack
FC1212-RD	305 x 305 x 305 mm	1
FC2212-RD	305 x 559 x 305 mm	1

Construction: Insulated with 1" foam padding and lined with extra tough, water-repellent nylon



PB17

PB20-6

PB20-12

PB25

Insulated Pizza Carriers

- Moisture-free insulation and lining
- Hanging loop for convenient storage option
- Stain-resistant 600 Denier shell

Item	Description	Thickness	Dimensions H x W x D	Pack
PB17	Holds up to: (4) 304.8 mm Pizza Boxes or (3) 355.6 mm Pizza Boxes	9.525 mm	127 x 419 x 432 mm	1
PB20-6	Holds up to: (3) 406.4 mm Pizza Boxes or (3) 457.2 mm Pizza Boxes		152 x 457 x 508 mm	1
PB20-12	Holds up to: (6) 406.4 mm Pizza Boxes or (6) 457.2 mm Pizza Boxes		305 x 457 x 508 mm	1
PB25	Holds up to: (2) 609.6 mm Pizza Boxes		152 x 660 x 635 mm	1



807FBPR



807FB-PK

Fryer Basket Identifiers

NEW



- HACCP colors for color-coding fryer vats
- Contoured design fits most fryer basket handles

Item	Description	Dimensions	Pack
807FBBL	Blue	62 x 59 x 14 mm	1
807FBYL	Yellow	62 x 59 x 14 mm	1
807FBBK	Black	62 x 59 x 14 mm	1
807FBPR	Purple	62 x 59 x 14 mm	1
807FBPK	Combo Pack Includes: (2) Blue, (2) Yellow, (1) Black, (1) Purple	62 x 59 x 14 mm	1

Perfect Pitcher™

- Patented "double-angled wall" reduces excess foaming that causes waste
- Allows bartenders to take orders, close tabs, and make other beverages for customers while pitcher fills

Item	Description	Dimensions H x W x D	Pack
PPP60	Beer Pitcher, 1.77 L capacity	228 x 165 x 178 mm	6



Bar Boards

- Durable co-polymer construction provides superior heat, chemical and warp resistance
- Material won't dull knives and resists unsanitary cut-grooving

Item	Color	Description	Dimensions H x W x D	Pack
CBG6938*	BK, GN, RD, WH, YL	Grip Boards	152 x 229 x 9.5 mm	6
CB6912WH	WH	Non-grip Boards	152 x 229 x 13 mm	6



Lettuce Koror™

- Tapered teeth allow for clean cuts into lettuce
- A wide opening and depth ensures full core removal

Item	Color	Cutting Diameter	Dimensions H x W	Pack
LK100	Green	51 mm	87 x 69 mm	1



Slide Check Racks

- Durable aluminum construction for long life
- Polished glass beads for smooth sliding

Item	Length	Dimensions H x W x D	Pack
CK6512A	305 mm	51 x 305 x 19 mm	6
CK6518A	458 mm	51 x 458 x 19 mm	6
CK6524A	610 mm	51 x 610 x 19 mm	6
CK6530A	762 mm	51 x 762 x 19 mm	6
CK6536A	915 mm	51 x 915 x 19 mm	6
CK6544A	1118 mm	51 x 1118 x 19 mm	6
CK6548A	1219 mm	51 x 1219 x 19 mm	6
CK6560A	1524 mm	51 x 1524 x 19 mm	6



Construction: Anodized Aluminum; Bagged with header card

Large Portion Control Digital Scale

- 4-in-1 configurations
- Sealed display
- Tare feature and automatic shut off

Item	Capacity	Increments	Dimensions H x W x D	Adapter/Batteries	Pack
SCDGPC13	6 kg	2 g	400 x 318 x 76 mm	Battery: N/A Adapter: Included	1







PERSONAL SAFETY

HIGH PERFORMANCE OVEN MITTS



FlexGuard™ **NEW**

- Pure silicone shell provides high heat & steam protection
- Seamless construction protects against liquids
- Textured surface for excellent grip during tasks
- Integrated magnet allows for easy storage and immediate availability

Item	Length	Description	Temperature Protection	Pack
FX15	381 mm	Conventional Style	Up to 363°C for 45 sec	1
FX17	432 mm	Conventional Style	Up to 363°C for 45 sec	1



Cool Touch Flame™ Oven Mitt

- Flame-resistant and extra durable due to Nomex® and Kevlar® surface
- Provides flame, heat and steam protection
- Integrated magnet allows for easy storage and immediate availability

Item	Length	Description	Temperature Protection	Pack
KT0212	330 mm	Conventional Style	Up to 280°C for 30 sec	1
KT0215	381 mm	Conventional Style	Up to 280°C for 30 sec	1
KT0218	432 mm	Conventional Style	Up to 280°C for 30 sec	1
KT0224	610 mm	Conventional Style	Up to 280°C for 30 sec	1
KT0112K	330 mm	Puppet Style	Up to 280°C for 30 sec	1
KT0115K	381 mm	Puppet Style	Up to 280°C for 30 sec	1
KT0118K	432 mm	Puppet Style	Up to 280°C for 30 sec	1
KT0124K	610 mm	Puppet Style	Up to 280°C for 30 sec	1



Cool Touch™ Oven Mitt

- Made with Kevlar® WebGuard™ for extra protection
- Provides heat and steam protection
- Integrated magnet allows for easy storage and immediate availability

Item	Length	Description	Temperature Protection	Pack
CTC13	330 mm	Conventional Style	Up to 260°C for 15 sec	1
CTC15	381 mm	Conventional Style	Up to 260°C for 15 sec	1
CTC17	432 mm	Conventional Style	Up to 260°C for 15 sec	1
CTC24	610 mm	Conventional Style	Up to 260°C for 15 sec	1
CTP13	330 mm	Puppet Style	Up to 260°C for 15 sec	1
CTP15	381 mm	Puppet Style	Up to 260°C for 15 sec	1
CTP17	432 mm	Puppet Style	Up to 260°C for 15 sec	1
CTP24	610 mm	Puppet Style	Up to 260°C for 15 sec	1

EZ-Kleen™ Oven Mitt

- Removable liner
- Easy to wipe clean; exterior & liner
- Provides heat and steam protection

Item	Length	Description	Temperature Protection	Pack
EZK15	381 mm	Conventional Style	Up to 232°C for 15 sec	1
EZK17	432 mm	Conventional Style	Up to 232°C for 15 sec	1



Oven Mitt with Kevlar®

- Durable, ambidextrous and ideal for handling abrasive items
- Made with fire retardant Kevlar®
- Machine washable

Item	Length	Color	Description	Temperature Protection	Pack
KM15	381 mm	Gold	Conventional Style	Up to 260°C for 30 sec	1
KM17	432 mm	Gold	Conventional Style	Up to 260°C for 30 sec	1



UltiGrips® Oven Mitt



- Cleans easily in sink and is dishwasher safe
- Non-slip, textured Neoprene material repels stains and provides superior grip ability in hot or cold applications
- WebGuard™ for extra protection & comfort

Item	Length	Color	Description	Temperature Protection	Pack
UCMX13BK	330 mm	Black	Conventional Style	-78°C up to 260°C for 15 sec	1
UCMX15BK	381 mm	Black	Conventional Style	-78°C up to 260°C for 15 sec	1
UCMX17BK	432 mm	Black	Conventional Style	-78°C up to 260°C for 15 sec	1
UPM15BK	381 mm	Black	Puppet Style	-78°C up to 260°C for 15 sec	1
UPM17BK	432 mm	Black	Puppet Style	-78°C up to 260°C for 15 sec	1



HIGH PERFORMANCE OVEN MITTS



BestGrip® Oven Mitt CE COMPLIANT

- Non-slip, textured Neoprene material repels stains and provides superior grip ability in hot applications
- Rinse in sink or wipe clean with damp cloth
- Integrated magnet allows for easy storage and immediate availability

Item	Length	Color	Description	Temperature Protection	Pack
810CM15	381 mm	Tan/Black	Conventional Style	Up to 260°C for 60 sec	1
810CM17	432 mm	Tan/Black	Conventional Style	Up to 260°C for 60 sec	1
810PM15	381 mm	Tan/Black	Puppet Style	Up to 260°C for 60 sec	1
810PM17	432 mm	Tan/Black	Puppet Style	Up to 260°C for 60 sec	1

Terry Oven Mitt



- Made with heavy-duty, institutional grade terry cloth
- Machine washable

Item	Length	Color	Description	Temperature Protection	Pack
813TM	330 mm	Natural	Conventional Style	Up to 260°C for 30 sec	1 pr
817TM	432 mm	Natural	Conventional Style	Up to 260°C for 30 sec	1 pr
824TM	610 mm	Natural	Conventional Style	Up to 260°C for 30 sec	1 pr
817TM-BR	432 mm	Brown	Conventional Style	Up to 260°C for 30 sec	1 pr
813TM-SB	330 mm	Natural	With Steam Barrier	Up to 260°C for 30 sec	1 pr
817TM-SB	432 mm	Natural	With Steam Barrier	Up to 260°C for 30 sec	1 pr

Kevlar® is a registered trademark of DuPont®

VALUE ADDED OVEN MITTS

BestGuard® Oven Mitt with Kevlar® WebGuard™



- Ambidextrous & fire retardant
- Wipes clean with a damp cloth

Item	Length	Color	Description	Temperature Protection	Pack
800FG13	330 mm	Tan	Conventional Style	Up to 232°C for 30 sec	1 pr
800FG15	381 mm	Tan	Conventional Style	Up to 232°C for 30 sec	1 pr
800FG17	432 mm	Tan	Conventional Style	Up to 232°C for 30 sec	1 pr
800FG24	610 mm	Tan	Conventional Style	Up to 232°C for 30 sec	1 pr
800FG13-BK	330 mm	Black	Conventional Style	Up to 232°C for 30 sec	1 pr
800FG15-BK	381 mm	Black	Conventional Style	Up to 232°C for 30 sec	1 pr
800FG17-BK	432 mm	Black	Conventional Style	Up to 232°C for 30 sec	1 pr
800FG24-BK	610 mm	Black	Conventional Style	Up to 232°C for 30 sec	1 pr



ECONOMY OVEN MITTS

Silicone Oven/Freezer Mitt

- Rinses clean
- Non-stick coating

Item	Length	Color	Description	Temperature Protection	Pack
801SG13	330 mm	Silver	Conventional Style	-18°C up to 204°C for 15 sec	1 pr
801SG15	381 mm	Silver	Conventional Style	-18°C up to 204°C for 15 sec	1 pr
801SG17	432 mm	Silver	Conventional Style	-18°C up to 204°C for 15 sec	1 pr



TEMPERATURE PROTECTION GLOVES



6786RMT

Fryer Oven Mitt

- Liquid-proof, seamless construction
- Cotton flocked inner lining
- Machine washable

Item	Length	Materials	Temperature Protection	Pack
6786RMT	356 mm	Neoprene rubber	Up to 260°C for 15 sec	1 pr
6786RMT-XL	432 mm	Neoprene rubber	Up to 260°C for 15 sec	1 pr



Frozen Food Glove



- Easy on/off
- Non-stick surface
- Great dexterity

Item	Size	Materials	Temperature Protection	Pack
FGI-OR	One size fits most	PVC with cotton jersey liner	As low as -18°C for 60 sec	1 pr



T1212

The Rotissi Glove

- Ideal for use in rotisserie pits
- Cotton flocked inner lining

Item	Length	Materials	Temperature Protection	Pack
T1212	305 mm	Neoprene rubber	Up to 260°C for 15 sec	1 pr
T1217	432 mm	Neoprene rubber	Up to 260°C for 15 sec	1 pr

POT HOLDERS & HANDLE HOLDERS

UltiGrips® Hot Pads

- Flexible and dishwasher safe
- Provides superior grip ability in hot or cold applications

Item	Size	Material	Temperature Protection	Pack
UHP55BK	140 x 140 mm	Non-slip, textured, Neoprene	-78° up to 260° C for 15 sec	1 ea
UHP77BK	178 x 178 mm	Non-slip, textured, Neoprene	-78° up to 260° C for 15 sec	1 ea
UHP1010BK	254 x 254 mm	Non-slip, textured, Neoprene	-78° up to 260° C for 15 sec	1 ea



EZ-Kleen™ Hot Pad

- Easy to wipe clean
- Provides heat and steam protection
- Wrist strap for ease of use

Item	Size	Material	Temperature Protection	Pack
EZKHP88	203 x 203 mm	Coated Poly-Cotton	Up to 232°C for 15 sec	1 ea



Silicone Handle Holder™

- Contoured for most cast iron pans
- Dishwasher safe
- Hanging hole for easy storage

Item	Color	Dimensions	Temperature Protection	Pack
806SHH*	BK (Black), PR (Purple)	51 x 140 mm	Up to 232°C for 15 sec	4 pk

Nomex® and Kevlar® are registered trademarks of DuPont®



CUT PROTECTION

Mani-Kare® Bandage Dispenser









- Pilferage-resistant with locked upper compartment
- Simple one-handed operation for ease of use
- One-at-a-time dispensing to reduce waste
- Wall-mounted to save space
- Blue colored bandages to avoid serving contaminated food
- Beige colored bandages also available

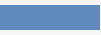

MKBD100



Item	Shape	Description	Bandage Color	Dimensions H x W	Pack
DISPENSERS					
MKBD100	Assorted	Dispenser with Blue Bandage Cartridges Includes: (1) large patch, (1) knuckle, (3) strip bandage cartridges, (1) Quick User Guide, (1) screw pack	Blue	162 x 305 x 51 mm	1 Ea
MKBD100BE	Assorted	Dispenser with Beige Bandage Cartridges Includes: (1) large patch, (1) knuckle, (3) strip bandage cartridges, (1) Quick User Guide, (1) screw pack	Beige	162 x 305 x 51 mm	1 Ea
REFILLS					
MKBR901		Blue Strip Bandage (3) cartridges of 15	Blue	25 x 76 mm	1 Pk
MKBR901BE		Beige Strip Bandage (3) cartridges of 15	Beige	25 x 76 mm	1 Pk
MKBR903		Blue Knuckle Bandage (3) cartridges of 10	Blue	38 x 76 mm	1 Pk
MKBR903BE		Beige Knuckle Bandage (3) cartridges of 10	Beige	38 x 76 mm	1 Pk
MKBR905		Blue Large Patch Bandage (3) cartridges of 10	Blue	51 x 76 mm	1 Pk
MKBR905BE		Beige Large Patch Bandage (3) cartridges of 10	Beige	51 x 76 mm	1 Pk
USER GUIDE					
MKQUG		Mani-Kare Quick User Guide Laminated wall chart	Blue	102 x 305 mm	1 Ea
MKQUGBE		Mani-Kare Quick User Guide Laminated wall char	Beige	102 x 305 mm	1 Ea

Bag Boa™ Bag Cutter and Squeegee



- Safely opens food bags
- Integrated squeegee eliminates food waste
- High-density plastic with stainless steel blade

Item	Dimensions L x W x D	Pack
BB100	330 x 44.5 x 6 mm	1



Klever Cutter™ Carton Opener



- Tough high-density plastic with stainless steel safety-type blades
- No need to change blades
- Prevents costly injuries to employees and damage to products

Item	Color	Pack
KK401	Red	1
KK401BL	Blue	1
KK401YL	Yellow	1
KK403	Red	1



CUT PROTECTION

Cut-Resistant Glove with Dyneema®



WITH EXCLUSIVE DOUBLE GUARD™ ANTIMICROBIAL AGENT

- 10 gauge Dyneema fiber
- Ambidextrous, lightweight & machine washable
- ANSI Level A7 cut protection



Item	Color	Size	Length	Material	Cut Protection	Pack
SG10-*	White	S, M, L, XL	279 mm	Dyneema*** composite yarn	Meets OSHA standard (29 CFR) 1910.132 - Tested in accordance with ASTM Spec 177.20	1
SG10-**	Blue (BL), Green (GN), Red (RD), Yellow (Y), Purple (P)	S, M, L	279 mm	Dyneema*** composite yarn	Meets OSHA standard (29 CFR) 1910.132 - Tested in accordance with ASTM Spec 177.20	1

***Dyneema® is a registered trademark of Royal DSM N.V. Under license of Double D Knitting & Glove, Inc.

Cut-Resistant Butcher Glove



WITH EXCLUSIVE DOUBLE GUARD™ ANTI-MICROBIAL AGENT

- 10 gauge yarn
- Ambidextrous, lightweight & machine washable
- ANSI Level A6 cut protection

Item	Size	Material	Cut Protection	Pack
PBS301-*	XS, S, M, L, XL	Stainless steel / nylon	ANSI Level A6 cut protection	1



Stainless Steel Mesh Cut-Resistant Glove

- Non-corrosive & easy to clean
- Antimicrobial wrist strap
- Great for deboning

Item	Size	Material	Pack
MGA515*	XS, S, M, L, XL	Stainless steel mesh	1



CHEMICAL PROTECTION - EZ-KLEEN™

- Easy to wipe clean
- Provides heat and steam protection

EZ-Kleen™ Sleeve

Item	Length	Material	Temperature Protection	Pack
EZKSL	406 mm	Coated Poly-Cotton	Up to 66°C for 15 sec	1 ea

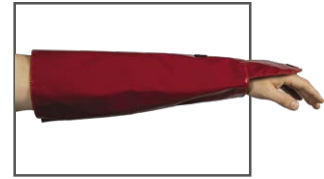

EZ-Kleen™ Shin Guards

Item	Material	Dimensions	Pack
EZKSHG	Coated Poly-Cotton	32 x 60 cm	1 pr



EZ-Kleen™ Apron

Item	Material	Dimensions	Pack
EZKAPR	Coated Poly-Cotton	65 x 91 cm	1 ea



EZ-Kleen™ Face Shield

Item	Material	Dimensions	Pack
EZKFS	Plastic	20 x 39 cm	1 ea

EZ-Kleen™ Kit

Item	Includes	Pack
EZKKIT	2 ea EZK15, 1 ea EZKFS, 1 ea EZKAPR, 1 pair EZKSHG	1 ea



CHEMICAL PROTECTION - APRONS

20 mil Vinyl Apron

- Protects against fats, liquids and abrasions
- Extra-long ties for added comfort

Item	Color	Thickness	Dimensions W x L	Material	Pack
614DVA20-GN	Green	20 mil	91 x 114 cm	Institutional grade quality vinyl	1
614DVA - WH20	White	20 mil	91 x 114 cm	Institutional grade quality vinyl	1



614DVA-WH20

614DVA20-GN





WASHROOM & HYGIENE SOLUTIONS

THE SUMMIT™ FAMILY IS GROWING

BLACK/STAINLESS LOOK

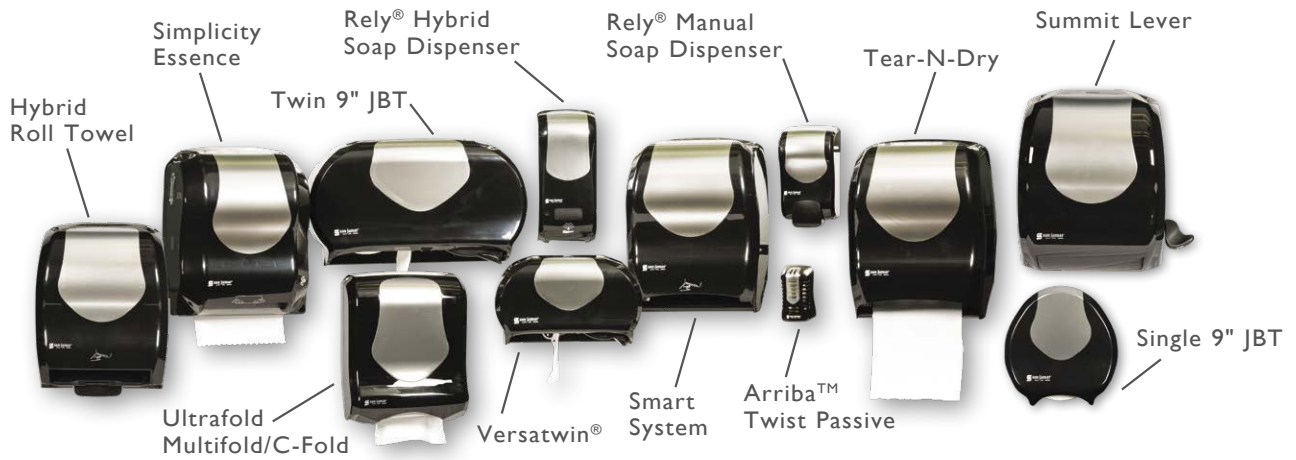

STAINLESS LOOK

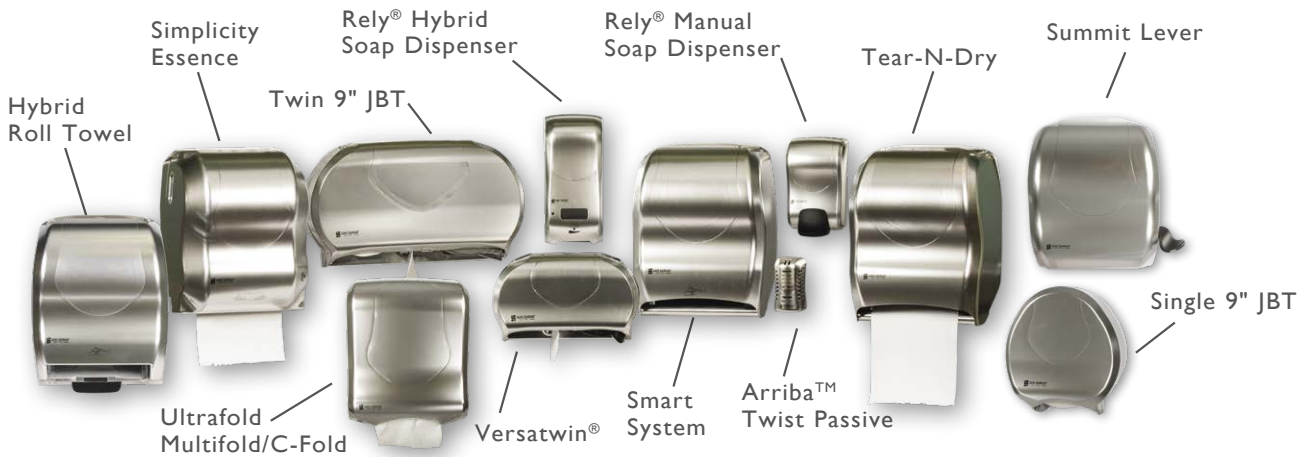

WHITE/CLEAR

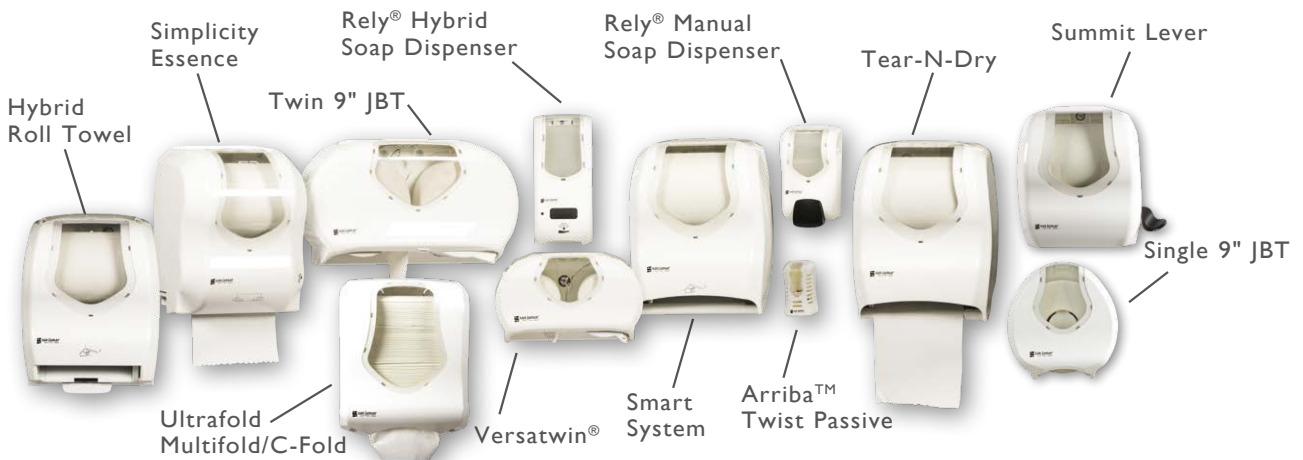

SUMMIT™ FAMILY CUSTOM OPTIONS

Visit Sanjamar.com/Summit to design your own dispenser and washroom. Or, go to the Apple or Android App Store to download our Summit™ App. See how Summit™ products fit in your Washroom.

Artwork can be molded into shield

LOW MINIMUMS

FAST TURN AROUND

with 12 pre-approved colors for back, cover & shield

BK Black	WH White	BR Brown	YL Yellow	OR Orange	RD Red
MN Maroon	PR Purple	BL Blue	DB Dark Blue	GN Green	DG Dark Green

Custom items have minimum purchase of 50 each.



CONTACT US TO ORDER!

NO-TOUCH ROLL TOWEL

- Touchless towel dispensers offer the best option for sanitary hand hygiene
- San Jamar leads the industry in Universal Touchless Electronic dispensing with four options: Smart Essence™, Smart System with I.Q. Sensor™ and the Tear-N-Dry
- Each of these durable dispensers offer best battery life in the industry
- Dispensing all types of 20 cm roll towel paper up to 250 m – any brand or quality



T7470BKSS



T7400TBK



T7400TBL



T7470SS

Simplicity Essence Hands-Free Mechanical

FEATURES STATE OF THE ART MECHANICAL HANDS-FREE DISPENSING



- Offers hands-free dispensing for most types of roll towel
- No batteries for easy maintenance
- Dispenses 254 mm portions of roll towel for 15% more dries per roll

Item	Color	Capacity	Core Diameter	Dimensions H x W x D	Pack
CLASSIC STYLE					
T7400*	TBK, TBL, WH	200 mm wide	38 mm	371 x 314 x 241 mm	1
SUMMIT™ STYLE					
T7470*	BKSS, TBK, SS, WHCL, CUSTOM	200 mm wide	38 mm	368 x 314 x 232 mm	1



T1470SS

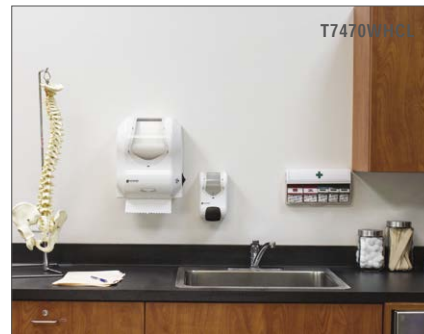

T7470WHCL

T1400TBL



T1470BKSS



T1400WHCL

Smart System WITH I.Q. SENSOR™



- Adjustable paper length and delay (0, 1½, 3 seconds)
- Infinity System® automatic transfer system eliminates stub roll waste
- Replaceable drive module

Item	Color	Capacity	Core Diameter	Dimensions H x W x D	Pack
CLASSIC STYLE					
T1400*	TBL, TBK, WHCL	200 mm wide roll dia. and 100 mm dia. stub roll	38 mm	419 x 298 x 235 mm	1
T1400TBKHW**	TBK	200 mm wide roll dia. and 100 mm dia. stub roll	38 mm	419 x 298 x 235 mm	1
SUMMIT™ STYLE					
T1470*	BKSS, SS, WHCL, CUSTOM	200 mm wide roll dia. and 100 mm dia. stub roll	38 mm	410 x 311 x 248 mm	1

Requires 4 D-cell alkaline batteries

**Includes hand washing sticker

Smart Essence™



- Adjustable paper length 200, 300, 400 mm and delay (0,1½, 3 seconds)
- Compact, high capacity
- Durable and economical

Item	Color	Capacity	Core Diameter	Dimensions H x W x D	Pack
T8400*	TBL, TBK, WH	200 mm wide roll	38 mm	367 x 298 x 232 mm	1

Requires 4 D-cell alkaline batteries



Hybrid Roll Towel



- Touchless Electronic Dispensing
- Adjustable paper length 200, 300, 400 mm and delay (0, 1½, 3 seconds)
- Manual "Push" Bar operation when batteries are low

Item	Color	Capacity	Core Diameter	Dimensions H x W x D	Pack
CLASSIC STYLE					
T8300*	TBK	200 mm wide roll	38 mm	419 x 298 x 235 mm	1
SUMMIT™ STYLE					
T8370*	BKSS, SS, WHCL, CUSTOM	200 mm wide roll	38 mm	410 x 311 x 248 mm	1

Requires 4 D-cell alkaline batteries



Tear-N-Dry



- Consistently dispenses standard 254 mm length paper without a wait
- Infinity System® automatic transfer system eliminates stub roll waste
- Replaceable drive module

Item	Color	Capacity	Core Diameter	Dimensions H x W x D	Pack
CLASSIC STYLE					
T1300*	TBL, TBK, WHCL	200 mm wide roll dia. and 100 mm dia. stub roll	38 mm	419 x 298 x 235 mm	1
SUMMIT™ STYLE					
T1370*	BKSS, SS, WHCL, CUSTOM	200 mm wide roll dia. and 100 mm dia. stub roll	38 mm	410 x 311 x 248 mm	1
OCEANS® STYLE					
T1390*	TBL, TBK	200 mm wide roll dia. and 100 mm dia. stub roll	38 mm	419 x 298 x 235 mm	1

Requires 4 D-cell alkaline batteries



* Specify desired color after item number. Example: T1370BKSS



T8090TBK

T8000TBL



T8090TBL

Tear-N-Dry Essence™



- Consistently dispenses standard 254 mm length paper without a wait
- Compact, high capacity
- Durable and economical

Item	Color	Capacity	Core Diameter	Dimensions H x W x D	Pack
CLASSIC STYLE					
T8000*	TBL, TBK, WH	200 mm wide roll	38 mm	367 x 298 x 232 mm	1
SUMMIT™ STYLE					
T8090*	TBL, TBKL	200 mm wide roll	38 mm	367 x 298 x 232 mm	1

Requires 4 D-cell alkaline batteries



Recessed Roll Towel



- Available for built-in or retrofit installations
- Two operating systems: Tear-N-Dry System or Smart System
- Two installation options — Universal for standard 200 mm diameter towel or ADA compliant for 152 mm diameter towel
- For retrofit installations, use item number XT800SS filler plate
- Easy to install in new construction or retrofit existing stainless steel cabinets

Item	Color	Capacity	Core Diameter	Dimensions H x W x D	Pack
TEAR-N-DRY STYLE					
T8006BKADA	Black	152 mm wide roll dia.	38 mm	448 x 368 x 187 mm 89 mm off the wall	1
T8008BKUNV	Black	203 mm wide roll dia.	38 mm	448 x 368 x 238 mm 127 mm off the wall	1
SMART SYSTEM STYLE					
T8406SSADA	Stainless Look	152 mm wide roll dia.	38 mm	448 x 368 x 187 mm 89 mm off the wall	1
T8408SSUNV	Stainless Look	203 mm wide roll dia.	38 mm	448 x 368 x 238 mm 127 mm off the wall	1



T7000TBK

T7090TBL

Simplicity Hands-Free Mechanical



- Hands-free dispensing for most types of roll towel
- Automatic mechanical cutting dispenses 280 mm portions of roll towel
- Replaceable drive module

Item	Color	Capacity	Core Diameter	Dimensions H x W x D	Pack
CLASSIC STYLE					
T7000*	TBL, TBK, WH	200 mm wide; 200 mm dia. roll Up to 100 mm dia. stub roll	38 mm	419 x 298 x 235 mm	1
OCEANS® STYLE					
T7090*	TBL, TBK	200 mm wide; 200 mm dia. roll Up to 100 mm dia. stub roll	38 mm	419 x 298 x 235 mm	1

Adjustable Centerpull Towel



- Easy to adjust funnel
- High capacity
- Universal centerpull dispenser, adjusts for all grades of paper from single ply to industrial wipes

Item	Color	Capacity	Dimensions H x W x D	Pack
T410*	TBL, TBK	229 mm wide; 229 mm dia. roll	340 x 244 x 238 mm	1

Construction: Impact resistant plastic



T410TBL

T410TBK

Adjustable Mini Centerpull Towel



- Easy to adjust funnel
- High capacity
- Universal centerpull dispenser, adjusts for all grades of paper from single ply to industrial wipes

Item	Color	Capacity	Dimensions H x W x D	Pack
T450	TBK	152 mm dia. roll	314 x 190 x 187 mm	1

Construction: Impact resistant plastic



Adjustable Centerpull Towel



- Large capacity ensures long intervals between refills
- Dispenses single sheets of one-ply perforated towels

Item	Color	Capacity	Dimensions H x W x D	Pack
T400*	TBL, TBK	230 mm dia. roll	295 x 232 x 241 mm	1

Construction: Impact resistant plastic



T400TBK

T400TBL

Perforated Roll Towel



- Large capacity ensures long intervals between refills
- Dispenses single sheets of one-ply perforated towels

Item	Color	Capacity	Dimensions H x W x D	Pack
T451XC	XC	280 mm wide roll	73 x 337 x 117 mm	1

Construction: Impact resistant plastic



* Specify desired color after item number. Example: T7000WH

TOUCH ROLL TOWEL

- Lowest cost way to dispense the lowest cost paper, hardwound roll towel
- Engineered for ease of use and minimal maintenance
- Impact resistant plastic for durability



Element™ Lever Roll Towel

- Compact, high capacity - 33% smaller than average roll towel dispenser
- Ergonomic handle; simple, efficient & easy to use
- Accepts any core size, including coreless, solid & centerpull rolls

Item	Color	Capacity	Core Diameter	Dimensions H x W x D	Pack
T950*	TBL, TBK, WHCL	200 mm wide; 200 mm dia. roll	All paper qualities with any size core	324 x 318 x 216 mm	1

Construction: Impact resistant plastic



Lever Roll Towel WITH AUTO TRANSFER

- Infinity System® automatic transfer system eliminates stub roll waste
- Replaceable drive module
- Simple, efficient & easy to use

Item	Color	Capacity	Core Diameter	Dimensions H x W x D	Pack
T1100*	TBL, TBK, WH	200 mm wide; 200 mm dia. roll Up to 100 mm dia. stub roll	38 mm	419 x 329 x 235 mm	1

Construction: Impact resistant plastic



Integra™ Lever Roll Towel

- Integrated dispensing arm for hands-free alternative dispensing
- Compact, high capacity
- Accepts any core size, including coreless, solid and centerpull rolls

Item	Color	Capacity	Core Diameter	Dimensions H x W x D	Pack
T850*	TBL, TBK, WHCL	215 mm dia. 209 mm wide	All paper qualities with any size core	342 x 292 x 285 mm	1

Construction: Impact resistant plastic

Crank Roll Towel

Item	Color	Capacity	Dimensions H x W x D	Pack
T800WH	WH	230 mm wide roll; 197 mm dia. roll	267 x 279 x 216 mm	1

Construction: Impact resistant plastic



FOLDED TOWEL

- Available in a variety of sizes for either compact or high capacity applications
- Designed to dispense any brand or quality of C-Fold or Multifold towels one-at-a-time, reducing waste
- Designed to eliminate overstuffing
- Constructed of impact-resistant plastic

Summit™ Ultrafold™ Multifold/C-Fold Towel



- New Summit design coordinates with Summit family
- Designed to eliminate overstuffing

Item	Color	Capacity	Dimensions H x W x D	Pack
T1770*	BKSS, SS, WHCL, CUSTOM	500 Multifold / 300 C-Fold	359 x 297 x 155 mm	1

Construction: Impact resistant plastic



T1770BKSS



T1770SS



T1770WHCL

Ultrafold™ Fusion™ Multifold/C-Fold Towel



- 50% smaller carton to save on warehouse and transportation costs
- Simple, 6 piece assembly

Item	Color	Capacity	Dimensions H x W x D	Pack
T1755*	TBL, TBK, WHCL	400 Multifold / 240 C-Fold	292 x 292 x 152 mm	1

Construction: Impact resistant plastic



T1755TBL



T1755TBK

* Specify desired color after item number. Example: T1770SS

Ultrafold™ Multifold/C-Fold Towel



- Compact
- Saves money with less towel waste

Item	Color	Capacity	Dimensions H x W x D	Pack
T1750*	TBL, TBK, WHCL	400 Multifold / 240 C-Fold	292 x 292 x 152 mm	1

Construction: Impact resistant plastic



T1750TBK



T1750TBL



T1750WHCL



T1700TBK

T1700TBL

Large Capacity Ultrafold™ Multifold/C-Fold Towel



- High capacity, reduces need to refill frequently

Item	Color	Capacity	Dimensions H x W x D	Pack
T1700*	TBL, TBK, WHCL	750 Multifold /450 C-Fold	475 x 298 x 159 mm	1

Construction: Impact resistant plastic

Premium Covered Countertop Towel Dispenser **NEW**



- Compact, ideal for spaces where wall mount dispensers are not an option
- Protects against moisture and contaminants



T1740WH

Item	Color	Capacity	Dimensions H x W x D	Pack
T1740*	BK, WH, SS	(1) Stack Multifold/C-fold/Singlefold. Holds up to 1.5 stacks of C-fold/Multifold towels	178 x 279 x 111 mm	1

Construction: Impact resistant plastic

True Fold™ C-Fold/Multifold Towel



- Operator-friendly flip door eliminates towel waste

Item	Color	Capacity	Dimensions H x W x D	Pack
T1905*	XC, WH	500 Multifold / 300 C-fold	368 x 295 x 127 mm	1

Construction: metal front/impact resistant plastic back



T1905XC

C-Fold/Multifold Towel



Item	Color	Capacity	Dimensions H x W x D	Pack
T1900*	XC, SS	500 Multifold / 300 C-fold	375 x 289 x 102 mm	1

Construction: 20-gauge steel



T1900XC

Mini C-Fold/Multifold Towel



Item	Color	Capacity	Dimensions H x W x D	Pack
T1950*	XC, SS	250 Multifold / 150 C-fold	200 x 283 x 98 mm	1

Construction: 20-gauge steel



T1950XC

Singlefold Towel



Item	Color	Capacity	Dimensions H x W x D	Pack
T1800*	XC, WH	500 Singlefold	191 x 273 x 152 mm	1

Construction: 20-gauge steel



T1800XC

* Specify desired color after item number. Example: T1700TBL



R3670SS



R3670BKSS



R3600TBK

R3670WHCL

R3600TBL

Versatwin® Tissue

- Accepts standard/industrial bath tissue
- Continual availability of paper provided by the Infinity System® eliminating stub roll waste

Item	Color	Capacity	Core Diameter	Dimensions H x W x D	Pack
CLASSIC STYLE					
R3600*	TBL, TBK, WH	(2) 115-140 mm rolls	38 mm	324 x 203 x 146 mm	1
SUMMIT™ STYLE					
R3670*	BKSS, SS, WHCL, CUSTOM	(2) 115-140 mm rolls	38 mm	324 x 197 x 149 mm	1

Construction: Impact resistant plastic

Twin 9" JBT

- Industry leading dispenser
- Continual availability of paper provided by the Infinity System®, eliminating stub roll waste



R4000TBL



R4070BKSS



R4070WHCL

Item	Color	Capacity	Core Diameter	Dimensions H x W x D	Pack
CLASSIC STYLE					
R4000*	TBL, TBK, WH	(2) 230 mm JBT rolls	83 mm	305 x 483 x 133 mm	1
SUMMIT™ STYLE					
R4070*	BKSS, SS, WHCL, CUSTOM	(2) 230 mm JBT rolls	83 mm	300 x 514 x 149 mm	1

Construction: Impact resistant plastic

57 mm core diameter available on request (San Jamar Europe)

Single 9" JBT

- Designed to provide ease-of-use, with easy paper access and multi-directional tearing



R2000WH

R2000TBL

Item	Color	Capacity	Core Diameter	Dimensions H x W x D	Pack
R2000*	TBL, TBK, WH	(1) 230 mm JBT roll	83 mm	305 x 260 x 143 mm	1

Construction: Impact resistant plastic

57 mm core diameter available on request (San Jamar Europe)

* Specify desired color after item number. Example: R4000TBL

SOAP

- Leading the way in solving universal soap dispensing needs
- Dispensing bulk hand soap, foam soap or sanitizer in dispensers that coordinate with your other San Jamar restroom dispensers
- Now taking the San Jamar hands free dispensing expertise into the soap line with Rely® Hybrid Soap Dispensers
- Foam or lotion

Rely® Hybrid Soap & Sanitizer Dispensers

- Touchless electronic soap & sanitizer dispensing
- Manual "Push-The-Cover" operation when batteries are low
- Accepts bulk hand sanitizers, lotion and foam soap

Item	Color	Capacity	Dimensions H x W x D	Pack
LIQUID & LOTION - CLASSIC STYLE				
SH900*	TBL, TBK, WH	875 ml 1 ml (full dose) or 0.5 ml (half dose) portion dispensed	305 x 140 x 102 mm	1
LIQUID & LOTION - SUMMIT™ STYLE				
SH970*	BKSS, SS, WHCL, CUSTOM	875 ml 1 ml (full dose) or 0.5 ml (half dose) portion dispensed	306 x 139 x 100 mm	1
FOAM - CLASSIC STYLE				
SHF900*	TBL, TBK, WH	825 ml 1 ml (full dose) or 0.5 ml (half dose) portion dispensed	305 x 140 x 102 mm	1
FOAM - SUMMIT™ STYLE				
SHF970*	BKSS, SS, WHCL, CUSTOM	825 ml 1 ml (full dose) or 0.5 ml (half dose) portion dispensed	306 x 139 x 100 mm	1

Construction: Impact resistant plastic



Rely® Manual Soap & Sanitizer Dispensers

- Available in 900 & 1300 ml capacities
- Accepts bulk hand sanitizers, lotion and foam soap
- Mounts easily with adhesive or screws

Item	Color	Capacity	Dimensions H x W x D	Pack
LIQUID & LOTION - CLASSIC STYLE				
S900*	TBL, TBK, WH	875 ml 0.6 ml portion dispensed	216 x 127 x 102 mm	1
S1300*	TBL, TBK, WH	1300 ml 0.6 ml portion dispensed	254 x 127 x 102 mm	1
LIQUID & LOTION - SUMMIT™ STYLE				
S970*	BKSS, SS, WHCL, CUSTOM	875 ml 0.6 ml portion dispensed	227 x 132 x 102 mm	1
FOAM - CLASSIC STYLE				
SF900*	TBL, TBK, WH	825 ml 0.5 ml portion dispensed	216 x 127 x 102 mm	1
SF1300*	TBL, TBK, WH	1300 ml 0.5 ml portion dispensed	254 x 127 x 102 mm	1
FOAM - SUMMIT™ STYLE				
SF970*	BKSS, SS, WHCL, CUSTOM	825 ml 0.5 ml portion dispensed	227 x 132 x 102 mm	1

Construction: Impact resistant plastic



Soap Dispensers - Lotion, Liquid or Foam



- Accommodates a wide variety of liquid, lotion (except pumice) and foam soaps
- Large push bar allows for easy dispensing

Item	Color	Capacity	Dimensions H x W x D	Pack
LIQUID & LOTION				
S30*	TBL, TBK	900 ml 0.8 ml portion dispensed	156 x 105 x 108 mm	1
S46*	TBL, TBK	1400 ml 0.6 ml portion dispensed	206 x 137 x 108 mm	1
FOAM				
SF30*	TBL, TBK	900 ml 0.2 ml portion dispensed	156 x 105 x 108 mm	1
SF46*	TBL, TBK	1400 ml 0.2 ml portion dispensed	206 x 137 x 108 mm	1

Construction: Impact resistant plastic

* Specify desired color after item number. Example: S46TBK



Kleen Keeper™ Wet Wipes Dispenser

- Keeps wipes canister in one handy place for storage; but also removable to go where the spills are
- Lid and foot fold flat to wall when not in use
- Prevents theft of canisters - requires removal of canister seal to dispense wipes



Item	Color	Capacity	Dimensions W x D	Pack
LIQUID & LOTION				
WD1010*	WH, BKSS, TP	Large wipe canisters 102 to 127 mm rim	146 x 177 mm Height will be determined by canister	1

Glove Dispensers

- Prevent boxes from becoming damaged or contaminated



Item	Color	Capacity	Construction	Pack
G0801	Stainless Steel	1 Box	22-gauge stainless steel	12
G0802	White	1 Box	22-gauge steel with white baked enamel	12
G0804	White	3 Boxes	22-gauge steel with white baked enamel	6
G0803	Clear	1 Box	High-grade flexible Plexiglas®	12
G0805	Clear	3 Boxes	High-grade flexible Plexiglas®	6

Construction: Impact resistant plastic

Plexiglas® is a registered trademark of Rohm and Haas.

AIR CARE

Arriba™ Twist Solaire™

- Battery-free fan dispersion
- Solar panels can harvest all forms of indoor lighting
- LED refill notification

Item	Color	Dimensions H x W x D	Pack
WS107 80 1207	Gray	178 x 79 x 89 mm	1
WS107 80 1208	White	178 x 79 x 89 mm	1



WS107 80 1208

Arriba™ Twist Fan

- Battery operated model features an intermittent fan
- Sensor activated - will turn off when lights are turned off
- LED refill notification

Item	Color	Dimensions H x W x D	Pack
WF107 80 1204	Gray	178 x 76 x 89 mm	1
WF107 80 1206	White	178 x 76 x 89 mm	1

Requires 2 C-cell alkaline batteries



WF107 80 1206

Arriba™ Twist Passive

- No batteries required
- Simple and silent operation

Item	Color	Dimensions H x W x D	Pack
WP107 80 1202	Gray	73 x 117 x 73 mm	1
WP107 80 1203	White	73 x 117 x 73 mm	1
SUMMIT™ STYLE			
WP9070*	BKSS, SS, WHCL, CUSTOM	73 x 117 x 73 mm	1



WP107 80 1203

WP9070BKSS

Arriba™ Twist Fragrances

- Each refill lasts 60 days and covers 170 m³

Item	Fragrance	Quantity	Pack
RW107 80 1226	English Garden	60 ml	1
RW107 80 1227	Pacific Glacier	60 ml	1
RW107 80 1228	Tropic Wave	60 ml	1
RW107 80 1230	Citrus Blossom	60 ml	1
RW107 80 1231	Pure Linen	60 ml	1
RW107 80 1232	Mango Burst	60 ml	1
RW107 80 1233	Crystal Pure	60 ml	1
RW107 80 1234	Prairie Flowers	60 ml	1
RW107 80 1255	Cinnamon Stick	60 ml	1
RW107 80 1256	Biscotti	60 ml	1
RW107 90 1257	Hazelnut Coffee	60 ml	1







DINNERWARE

MELAMINE DINNERWARE

- Durable melamine resists staining, chipping and cracking
- Safe for temperatures up to 100°C
- One-year limited warranty

Stadia Dinnerware **NEW**



- Stadium-shaped bowls and coupe plates offer options for any setting
- Look and feel of china without the replacement cost



Prod No	Description	Color	Pack
53000	26.67 cm Dinner Plate	02, 80	12 ea
53001	22.86 cm Salad Plate	02, 80	12 ea
53002	18.415 cm Bread and Butter Plate	02, 80	12 ea
53003	21.59 cm Pasta Plate	02, 80	12 ea
53004	24.13 cm Pasta Plate	02, 80	12 ea
53005	29.21 cm Pasta Plate	02, 80	12 ea
53006	340 ml Bowl	02, 80	12 ea
53007	907 ml Bowl	02, 80	12 ea
53008	1474 ml Bowl	02, 80	12 ea
53009	33.02 cm x 43.18 cm Platter	02, 80	12 ea
53010	118 ml Sauce Cup	02, 80	24 ea
53011	59 ml Sauce Cup	02, 80	24 ea

Note: Melamine Dinnerware is not recommended for microwave



Ridge Dinnerware **NEW**



- Natural colors compliment any plate from ethnic-inspired dishes to farm-to-table culinary creations
- Featuring modern, minimalist organic shapes, premium texture and matte finish
- Ideal where breakage is a concern, such as the poolside

Prod No	Description	Color	Pack
53107	26.67 cm Dinner Plate	23, 37, 38, 72	12 ea
53101	25.4 cm Coupe Plate	23, 37, 38, 72	12 ea
53106	22.86 cm Salad Plate	23, 37, 38, 72	12 ea
53105	27.94 cm Rimless Plate	23, 37, 38, 72	12 ea
53104	22.86 cm Rimless Plate	23, 37, 38, 72	12 ea
53103	45.72 cm Oblong Platter	23, 37, 38, 72	6 ea
53102	33.02 cm Oblong Platter	23, 37, 38, 72	6 ea
53109	1474 ml Bowl	23, 37, 38, 72	12 ea
53108	624 ml Bowl	23, 37, 38, 72	12 ea
53110	227 ml Bouillon Bowl	23, 37, 38, 72	24 ea



Note: Melamine Dinnerware is not recommended for microwave



Halcyon Dinnerware  

- Unique design enhances the appearance of plated foods
- Resists oils and staining
- Wide variety including 26 shapes and sizes of plates, platters, serving cups and bowls

Prod No	Description	Color	Pack	Prod No	Description	Color	Pack
HAL01	12.7 cm, 340 ml Flared Rim Appetizer Cup	02	12 ea	HAL16	25.4 cm Serving Platter	02	12 ea
HAL02	14 cm, 510 ml Flared Rim Appetizer Cup	02	12 ea	HAL17	29.21 cm Serving Platter	02	12 ea
HAL03	25.4 cm, 454 ml Oval Pasta Bowl	02	12 ea	HAL18	33.02 cm Serving Platter	02	6 ea
HAL04	30.5 cm, 170 ml Round Pasta Bowl	02	12 ea	HAL20	10.2 cm, 567 ml Petite Sauce Bowl	02	24 ea
HAL05	12.7 cm, 312 ml Angled Appetizer Cup	02	12 ea	HAL21	11.43 cm, 57 ml Handled Sauce Bowl	02	24 ea
HAL06	15.24 cm, 454 ml Angled Appetizer Cup	02	12 ea	HAL22	28 cm, 227 ml Top Hat Pasta Bowl	02	12 ea
HAL09	22.86 cm Square Rim Plate	02	12 ea	HAL23	30.5 cm, 142 ml Oval Low Bowl	02	12 ea
HAL10	26.67 cm Square Rim Plate	02	12 ea	HAL24	26.7 cm × 16.5 cm Small Serving Plate	02	12 ea
HAL11	30.5 cm Square Rim Plate	02	12 ea	HAL26	33 cm × 16.5 cm Sleigh Tray	02	12 ea
HAL12	3 Compartment Tray	02	6 ea	HAL27	7.4 ml Pho Spoon	02	48 ea
HAL13	7.62 × 17.8 × 7.62 cm, 85 ml Small Lily Bowl	02	12 ea	HAL28	7.4 ml Broth Spoon	02	48 ea
HAL14	26.67 × 22.86 × 10.80 cm, 227 ml Medium Lily Bowl	02	12 ea	HAL31	6.35 cm, 30 ml Spoon Bowl	02	48 ea
HAL15	29.21 × 24.13 cm × 11.43 cm, 284 ml Large Lily Bowl	02	12 ea	HAL32	8.89 cm, 59 ml Handled Bowl	02	48 ea

Note: Melamine Dinnerware is not recommended for microwave

White(02)



Mingle Dinnerware



- Perfect for any casual venue where durability is ideal
- Base color mimics ceramics



Prod No	Description	Color	Pack
54001	28 cm Dinner Plate	13, 15, 17, 18, 46, 52	12 ea
54002	22.9 cm Salad Plate	13, 15, 17, 18, 46, 52	12 ea
54003	22.9 cm, 843 ml Rimmed Soup	13, 15, 17, 18, 46, 52	6 ea
54004	17.8 cm, 765 ml Ice Cream Bowl	13, 15, 17, 18, 46, 52	12 ea
54005	15.24 cm, 482 ml Bowl	13, 15, 17, 18, 46, 52	12 ea
54007	17.8 cm Bread & Butter Plate	13, 15, 17, 18, 46, 52	12 ea
54018	12.7 cm, 127 ml Fruit Bowl	13, 15, 17, 18, 46, 52	48 ea
54019	20.32 cm, 1006 ml Cereal Bowl	13, 15, 17, 18, 46, 52	12 ea

Note: Melamine Dinnerware is not recommended for microwave

Grove Dinnerware



- Temperature insulated; resists drawing heat or cold away from food
- Durable, heavy-weight melamine with the look of stoneware resists chipping and breakage
- Mix and match Grove's complimentary neutral colors or pair with traditional solid pieces from other collections

Prod No	Description	Color	Pack
64001	27.94 cm Dinner Plate	06, 15*, 18, 46, 70	12 ea
64002	22.9 cm Salad Plate	06, 15, 18, 46, 70	12 ea
64007	17.8 cm Bread & Butter Plate	06, 15, 18, 46, 70	12 ea
64020	30.5 cm x 20.32 cm Oval Plate	06*, 15, 18, 46, 70	12 ea
64022	26.67 cm x 26.67 cm Square Dinner Plate	06, 15, 18, 46, 70	12 ea
64023	21.59 cm x 21.59 cm Square Salad Plate	06, 15, 18, 46*, 70*	12 ea
64003	22.9 cm, 843 ml Soup Bowl	06, 15, 18, 46, 70	6 ea
64005	15.24 cm, 482 ml Small Bowl	06, 15, 18, 46*, 70	12 ea
64013	17.8 cm, 765 ml Ice Cream Bowl	06*, 15, 18, 46, 70	12 ea
64018	12.7 cm, 128 ml Fruit Bowl	06, 15, 18, 46, 70	48 ea

* Color available by special order only

Note: Melamine Dinnerware is not recommended for microwave

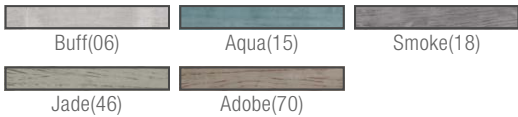

Gathering Dinnerware



- European coupe design is on-trend and offers larger plating surfaces
- The unique look fits perfectly within the farm-to-table setting



Prod No	Description	Color	Pack
GA55001	27.94 cm Dinner Plate	Adobe (70)	12 ea
GA55002	22.9 cm Salad Plate	Adobe (70)	12 ea
GA55008	17.8 cm Bread & Butter Plate	Adobe (70)	12 ea
GA55003	20.32 cm, 1006 ml Small Bowl	Adobe (70)	12 ea
GA55011	15.24 cm, 567 ml Small Bowl	Adobe (70)	12 ea
GA55012	11.73 cm, 255 ml Dip Bowl	Adobe (70)	12 ea
GA55013	31.75 cm Charger Plate	Adobe (70)	12 ea
GA55014	30.5 x 20.32 cm Oval Platter	Adobe (70)	12 ea

Note: Melamine Dinnerware is not recommended for microwave

Kingline™ Dinnerware



- Top choice for schools
- Reinforced at vital stress points

Prod No	Description	Color	Pack
KINGLINE PLATES			
KL116	25.4 cm Dinner Plate	02, 03, 25	48 ea
KL200	22.9 cm Dinner Plate	02, 03, 05, 25, 70	48 ea
KL920	22.9 cm Dinner Plate	92	48 ea
KL201	18.42 cm Sandwich Plate	02, 03, 05, 25	48 ea
KL204	16.5 cm Pie Plate	02, 03, 05, 25	48 ea
KL205	13.97 cm Bread & Butter Plate	02, 25, 70	48 ea
KINGLINE COMPARTMENT PLATES			
KL102	25.4 cm, 1.91 cm D, 3-Compartment Plate	02, 25, 70	48 ea
KL203	22.23 cm, 3.18 cm D, 3-Compartment Plate	02, 25	12 ea
Kingline Oval Platters			
KL126	34.29 x 24.77 cm Oval Platter	02, 25	12 ea
KL127	30.5 x 22.9 cm Oval Platter	02, 03, 05, 25, 70**	12 ea
KINGLINE BOWLS & CUP			
KL350	226.80 ml Bouillon Cup	02, 03, 05, 25	48 ea
KL115	453.59 ml, 15.57 cm Chowder Bowl	02, 25	48 ea
KL108	396.90 ml, 13.97 cm Nappie Bowl	02, 25	48 ea
KL119	354.37 ml, 13.97 cm Rimmed Nappie Bowl	02, 25	48 ea
KL924	354.37 ml, 13.97 cm Rimmed Nappie Bowl	92	48 ea
KL121	283.5 ml, 14.94 cm Mlrapefruit Bowl	02, 25	48 ea
KL118	283.5 ml, 13.03 cm Nappie Bowl	02, 03, 05, 25	48 ea
KL123	226.80 ml, 19.69 cm Wide Rimmed Salad Bowl	02	48 ea
KL800	141.75 ml, 12.7 cm Rimmed Fruit Bowl	02, 25, 70	48 ea
KL805	134.66 ml, 11.43 cm Rimmed Fruit Bowl	02, 03, 05, 25	48 ea
KL928	134.66 ml, 10.80 cm Rimmed Fruit Bowl	92	48 ea



KL102



KL127

KL350

KL201

DINNERWARE ACCENT PIECES

Epicure®  

- European coupe design combines strength and beauty with functionality
- Coupe design offers larger serving area

Prod No	Description	Color	Pack
EPICURE DINNERWARE			
43800	30.5 cm Buffet/Pizza Plate	02	12 ea
43801	25.4 cm Dinner Plate	02	48 ea
43803	20.32 cm Dinner Plate	02	48 ea
5933	907.19 ml, 20.96 cm Vegetable Bowl	02	24 ea
43813	1020.58 ml, 20.32 cm Chef Salad/Serving Bowl	02	12 ea
43814	566.99 ml, 16.5 cm Soup/Salad Bowl	02	12 ea
EPICURE SHAPES			
43806	27.94 cm TriArc Plate	02, 03*	4 ea
43822	15.88 cm Square Plate	02	48 ea

* Color available by special order only



Tulip Dishes   

- Ideal for serving ice cream, puddings, salads and more
- Made of break-resistant SAN
- 4532, 4534 are also available in extra-durable polycarbonate

Prod No	Description	Color	Pack
4530	142 ml, 9.53 cm SAN Tulip Dessert Dish	03, 07, 42, 54	24 ea
4532	142 ml, 9.53 cm PC Tulip Dessert Dish	07	24 ea
4531	142 ml, 11.76 cm SAN Tulip Berry Dish	03, 07, 42	24 ea
4535	227 ml, 11.76 cm SAN Tulip Berry Dish	07	48 ea
4533	369 ml, 13.97 cm SAN Tulip Bowl	07	24 ea
4534	369 ml, 13.97 cm PC Tulip Bowl	07	24 ea

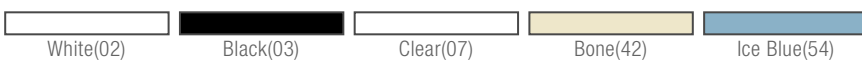

PLATE COVERS

Polyglass Plate Covers

- Available to fit a wide variety of plate sizes and footprints
- Polyglass (PG) plate covers are designed for use in microwaves and heated carts
- Heat resistant to 132°C yet stays cool to the touch; excellent insulation properties
- Impact-resistant material offers a superior alternative to standard fiberglass covers

Prod No	Description	Color	Pack
91020	22.23 cm – 23.19 cm Polyglass Cover	202	12 ea
91040*	24.13 cm – 25.4 cm Polyglass Cover	202	12 ea
91055	25.73 cm – 26.67 cm Polyglass Cover	202	12 ea
91070	26.04 cm – 27 cm Polyglass Cover	202	12 ea
91065	25.73 cm – 26.37 cm Polyglass Cover	202	12 ea
91080	26.67 cm – 27.31 cm Polyglass Cover	202, 203	12 ea
91075	27 cm – 27.15 cm Polyglass Cover	202	12 ea
91085	27.94 cm – 28.58 cm Polyglass Cover	202	12 ea
91090	29.85 cm – 30.5 cm Polyglass Cover	202	12 ea
91095	30.5 cm – 31.11 cm Polyglass Cover	202	12 ea

* Item available by special order only



Polycarbonate Plate Covers

- Clear covers for easy viewing of food
- Highly heat- and break-resistant
- 1960 and 1992 also fit European "pin-fired" footless style plates for secure stacking
- Can be used in heated carts or under heat lamps up to 100°C

Prod No	Description	Color	Pack
1900	22.07 cm to 23.19 cm PC Cover	Clear (07)	12 ea
1960	22.9 cm Combination "Pin-Fired" Plate & Bowl PC Cover	Clear (07)	12 ea
1965	23.98 cm to 24.77 cm PC Cover	Clear (07)	12 ea
1987	24.92 cm to 25.4 cm PC Cover	Clear (07)	12 ea
1989	27.46 cm to 26.04 cm PC Cover	Clear (07)	12 ea
1991	26.67 cm to 27 cm PC Cover	Clear (07)	12 ea
1992	26.67 cm to 27 cm "Pin-Fired" PC Cover	Clear (07)	12 ea
1993	27.31 cm to 27.94 cm PC Cover	Clear (07)	12 ea
1994	30.5 cm PC Cover	Clear (07)	12 ea





CARLISLE
FOODSERVICE PRODUCTS



DRINKWARE

DRINKWARE

Alibi™ Barware  

- Resistant to staining, breaking and chipping
- Light-weight and durable, making it essential for special occasions and outdoor events
- Thick base on barware feels like traditional glassware
- Wide assortment of styles to choose from



Prod No	Description	Glass Rack	Color	Pack
5601	44.36 ml Alibi Shot	RG49	07 (Clear)	24 ea
5602	59.15 ml Alibi Shooter	RG49	07 (Clear)	24 ea
5603	88.72 ml Alibi Shooter/Mini Dessert	RG49	07 (Clear)	24 ea
5609	266.16 ml Alibi Rocks/Juice	RG25-1, RW20	07 (Clear)	24 ea
5610	295.74 ml Alibi Hi-Ball	RG49-2	07 (Clear)	24 ea
5612	354.88 ml Alibi Double Old Fashioned	RG16-1, RW20	07 (Clear)	24 ea
5614	414.03 ml Alibi Beverage	RG25-2, RW30-1	07 (Clear)	24 ea
5616	473.18 ml Alibi 1/2 Liter/Mixing	RG16-2, RW20-1	07 (Clear)	24 ea



Alibi™ Stemware  

- Polycarbonate material is resistant to staining, breaking and chipping
- Great for special occasions and outdoor events
- Thick base & thin stem mimics traditional glassware

Prod No	Description	Glass Rack	Color	Pack
5644	177.44 ml Alibi Champagne Flute	RG49-4	07 (Clear)	24 ea
5640	236.59 ml Alibi Champagne Flute	RG25-5, RW20-4C, RW30-4	07 (Clear)	24 ea
5645	236.59 ml Alibi White Wine	RG25-3, RG36-3, RW30-2	07 (Clear)	24 ea
5643	325.31 ml Alibi White Wine	RG16-4, RW20-3	07 (Clear)	24 ea
5646	266.16 ml Alibi Martini	RG9-3	07 (Clear)	24 ea
5642	591.47 ml Alibi Red Wine	RG16-4, RW20-3	07 (Clear)	24 ea
5641	650.62 ml Alibi Balloon	RG16-4	07 (Clear)	24 ea
5648	443.60 ml Water	RG25-3, RW20-2	07 (Clear)	24 ea
5649	473.18 ml Pilsner	RG25-5, RW20-4C, RW30-4	07 (Clear)	24 ea
5650	473.18 ml Hurricane	RG36-4, RW30-3	07 (Clear)	24 ea
5651	325.31 ml Margarita	RG9-3	07 (Clear)	24 ea
5652	473.18 ml Margarita, Grande	RG9-3	07 (Clear)	24 ea

Mingle



- The look and feel of recycled glass drinkware
- Tritan offers durability that withstands heavy use in your venue
- Durable Tritan is break and craze-resistant
- Strain resistant



Prod No	Description	Glass Rack	Color	Pack
MIN5441	177.44 ml Juice Cup	RG49-1	07, 15, 18	12 ea
MIN5440	414.03 ml Double Old Fashioned	RG16-1, RW20	07, 15, 18	12 ea
MIN5442	561.90 ml Highball	RG16-2, RW20-1	07, 15, 18	12 ea
MIN5449	650.62 ml High Ball	RG16-3, RW20-2	07	12 ea

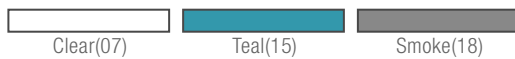

POLYCARBONATE
DRINKWARE



Liberty™ 

- Serve poolside drinks without the breakage worries of glass
- Liberty polycarbonate eliminates the need to sacrifice your presentation with disposables

Prod No	Description	Glass Rack	Color	Pack
43628	236.59 ml Liberty Old Fashioned	RG25-1, RW30	07 (Clear)	48 ea
43625	532.32 ml Liberty Double Old Fashioned	RG16-2, RW20-1	07 (Clear)	24 ea
43626	650.62 ml Liberty Hi-Ball	RG16-3, RW20-2	07 (Clear)	24 ea
43623	443.60 ml Liberty Pilsner	RG25-4, RW20-3	07 (Clear)	24 ea
43624	280.95 ml Liberty Margarita	RG9-3	07 (Clear)	24 ea
43627	236.59 ml Liberty Martini	RG16-3, RG9-3	07 (Clear)	24 ea
43629	266.16 ml Liberty Cocktail	RG25-3, RW20-2	07 (Clear)	24 ea
43620	147.87 ml Liberty Champagne Flute	RG25-4, RW20-3	07 (Clear)	24 ea
43631	443.60 ml Liberty Hurricane	RG25-4, RW20-3	07 (Clear)	24 ea
43630	384.46 ml Liberty Cocktail	RG25-3, RW20-2	07 (Clear)	24 ea
43621	310.52 ml Liberty White Wine	RG16-3, RG25-3, RW20-2	07 (Clear)	24 ea
43622	399.24 ml Liberty Goblet	RG16-3, RW20-2	07 (Clear)	24 ea

SAN TUMBLERS



Stackable



- Durable SAN reduces breakage
- Tapered sides make tumblers easy to stack
- Interior lugs prevent jamming when stored
- Textured exterior hides wear and tear

Note: Please specify case pack when ordering

Prod No	Description	Disposable Lid	Glass Rack	Color	Pack
LARGE PACKS					
5501	147.87 ml SAN Stackable Tumbler	DX1193ST8714*	RG49-1	07, 10, 13, 47, 54	72 ea
5526	236.59 ml SAN Stackable Tumbler	DX1191ST8714*	RG36-1	07, 10, 13, 47, 54	72 ea
5529	266.16 ml Old Fashioned SAN Stackable Tumbler	DXTT58*	RG25-1, RW20	07, 13	72 ea
5506	280.95 ml SAN Stackable Tumbler	5506L	RG25-1, RG36-1, RW30	07, 10, 13, 47, 54	72 ea
5212	354.88 ml SAN Stackable Tumbler	5212L	RG25-2, RW20-1, RW30-1	07, 10, 13, 47, 54	72 ea
5216	473.18 ml SAN Stackable Tumbler	DXTT58*	RG25-2, RW20-1	07, 10, 13, 47, 54	72 ea
5220	591.47 ml SAN Stackable Tumbler	DX30008714*	RG16-3, RW20-2	07, 10, 13, 47, 54	72 ea
5224	709.76 ml SAN Stackable Tumbler	DXTT45*	RG16-3, RW20-2	07, 10, 13	72 ea
5232	946.35 ml Tall SAN Stackable Tumbler	—	RG16-4	07, 10	24 ea
5532	946.35 ml SAN Stackable Tumbler	—	RG16-3	07, 10, 13	48 ea
43937	162.65 ml Low Profile SAN Stackable Tumbler	—	RG16, RW20	07	72 ea
SMALL PACKS					
5501-2	147.87 ml SAN Stackable Tumbler	DX1193ST8714*	RG49-1	07	24 ea
5526-2	236.59 ml SAN Stackable Tumbler	—	RG36-1	07	24 ea
5529-2	266.16 ml Old Fashioned SAN Stackable Tumbler	DXTT58*	RG25-1, RW20	07	24 ea
5532-2	946.35 ml SAN Stackable Tumbler	—	RG16-3	07**	24 ea
5506-2	280.95 ml SAN Stackable Tumbler	5506L	RG25-1, RG36-1, RW30	07	24 ea
5212-2	354.88 ml SAN Stackable Tumbler	5212L	RG25-2, RW20-1, RW30-1	07	24 ea
5216-2	473.18 ml SAN Stackable Tumbler	DXTT58*	RG25-2, RW20-1	07	24 ea
5220-2	591.47 ml SAN Stackable Tumbler	DX30008714*	RG16-3, RW20-2	07	24 ea



Louis™



- Stackable space saving feature
- Faceted shape offers easy grip
- Appearance of glass



Prod No	Description	Disposable Lid	Glass Rack	Color	Pack
5806	177.44 ml Louis Tumbler	DX11968714*	RG25-1, RG36-1, RW30	07 (Clear)	24 ea
5808	236.59 ml Louis Rocks	DX22259000*	RG25-1, RW20	07 (Clear)	24 ea
5810	295.74 ml Louis Tumbler	5810L	RG25-1, RW30	07 (Clear)	24 ea
5812	354.88 ml Louis Rocks	5812L	RG16-1, RW20	07 (Clear)	24 ea
5814	414.03 ml Louis Tumbler	DXTT501*	RG25-2, RW20-1, RW30-1	07 (Clear)	24 ea
5816	473.18 ml Louis Tumbler	DXTT58*	RG25-2, RW20-1	07 (Clear)	24 ea
5818	532.32 ml Louis Tumbler	DXTT58*	RG25-3, RW20-2	07 (Clear)	24 ea
5820	591.47 ml Louis Tumbler	—	RG16-3, RW20-2	07 (Clear)	24 ea
5822	650.62 ml Louis Tumbler	5822L	RG16-3, RW20-2	07 (Clear)	24 ea
5832	946.35 ml Louis Tumbler	—	RG16-3	07 (Clear)	24 ea

Lorraine™



- Attractive panel and facet design
- Stacking lugs prevent jamming



Prod No	Description	Disposable Lid	Glass Rack	Color	Pack
43647	177.44 ml Lorraine Tumbler	—	RG36-1, RW30	07 (Clear)	24 ea
43648	236.59 ml Lorraine Tumbler	1110L	RG25-1, RW30	07 (Clear)	24 ea
43649	266.16 ml Lorraine Old Fashioned Tumbler	DXTT59*	RG16-1, RW20	07 (Clear)	24 ea
43651	354.88 ml Lorraine Tumbler	—	RG25-2, RW20-1	07 (Clear)	24 ea
43653	473.18 ml Lorraine Tumbler	DX30008714*	RG16-2, RW20-1	07 (Clear)	24 ea
43655	650.62 ml Lorraine Tumbler	—	RG16-3	07 (Clear)	24 ea



Bistro™



- Attractive traditional fluted exterior
- Interior lugs prevent jamming when stored

Prod No	Description	Disposable Lid	Glass Rack	Color	Pack
1104	118.29 ml Bistro Tumbler	—	RG49-1	07 (Clear)	144 ea
1105	147.87 ml Bistro Tumbler	DX11928714*	RG49-1	07 (Clear)	144 ea
1108	236.59 ml Bistro Tumbler	—	RG36-1, RW30	07 (Clear)	72 ea
1110	295.74 ml Bistro Tumbler	1110L	RG25-1, RW30	07 (Clear)	72 ea
1112	354.88 ml Bistro Tumbler	DX11808714*	RG25-2, RW30-1	07 (Clear)	72 ea
1116	473.18 ml Bistro Tumbler	—	RG25-2, RW20-1	07 (Clear)	72 ea
0120	591.47 ml Bistro Tumbler	DX21259000*	RG16-3, RG25-3, RW20-2	07 (Clear)	72 ea
0132	946.35 ml Bistro Tumbler	—	RG16-3	07 (Clear)	48 ea

Crystalon® Stack-All®



- Stylish, ribbed texture offers better grip
- Stacking lugs prevent jamming when stored



Prod No	Description	Disposable Lid	Glass Rack	Color	Pack
4008	236.59 ml Crystalon SAN Tumbler	DX1198ST8714*	RG25-1, RW30	07, 55	48 ea
4029	266.16 ml Old Fashioned Crystalon SAN Tumbler	DX21259000*	RG25, RW20	07, 55**, 64	48 ea
4010	280.95 ml Crystalon SAN Tumbler	—	RG25-1, RW30	07, 54	48 ea
4012	354.88 ml Crystalon SAN Tumbler	5212L	RG25-2, RW20-1	07, 13, 54, 55, 64	48 ea
4016	473.18 ml Crystalon SAN Tumbler	DXTT58*	RG25-2, RW20-1	07, 13, 54, 55, 64	48 ea
4020	591.47 ml Crystalon SAN Tumbler	—	RG16-2, RW20-1	07, 13, 54, 55, 64	48 ea



*The DX Series Disposable Lids listed above are available through the Carlisle | Dinex Catalog

**Color available by special order only



439945200

Genuine Coca-Cola® Tumbler



- Classic shape with the appearance of glass
- Stackable and break-resistant
- Available in clear with Coca-Cola® logo

Prod No	Description	Glass Rack	Pack
439945200	709.76 ml Coca-Cola Tumbler with Logo	RTP	72 ea



5509

5517

5505

5508

Pebble Optic™



- Attractive pebbled exterior hides scratches
- Thick-walled SAN construction offers sturdy feel
- 5oz, 8oz, 9.5oz and 12oz sizes having stacking feature on bottom

Prod No	Description	Disposable Lid	Glass Rack	Color	Pack
5505	147.87 ml Pebble Optic Tumbler	DX24019000*	RG49-1	07	24 ea
5508	236.59 ml Pebble Optic Tumbler	—	RG36-1	07	24 ea
5509	280.95 ml Pebble Optic Tumbler	—	RG25-1, RW30	07, 10**, 18	24 ea
5512	354.88 ml Pebble Optic Tumbler	DX1198ST8714*	RG36-2, RW30-1	07, 10, 18	24 ea
5517	473.18 ml Pebble Optic Tumbler	—	RG25-2, RW20-1, RW30-1	07, 10, 18	24 ea
5519	591.47 ml Pebble Optic Tumbler	DX11948714	RG25-3, RW20-2, RW30-2	07	24 ea



Note: *The DX Series Disposable Lids listed above are available through our Dinex Catalog

**Color available by special order only

POLYCARBONATE TUMBLERS



Crystalon® RimGlow™

- Tumblers change hue and intensity with variations in lighting, perspective and beverage color
- Mix and match colors in brilliant, long-lasting polycarbonate

Prod No	Description	Disposable Lid	Glass Rack	Color	Pack
4033	354.88 ml Crystalon PC Tumbler	5212L	RG25-2, RW20-1, RW30-1	09, 14, 22**	48 ea
4034	473.18 ml Crystalon PC Tumbler	DXTT58*	RG25-2, RW20-1	07, 09, 14, 22**	48 ea
4035	591.47 ml Crystalon PC Tumbler	—	RG16-2, RG16-3, RW20-1, RW20-2	09, 14, 22	48 ea

Stackable

- Ideal for prisons, schools and high-volume chains
- Extremely break-resistant polycarbonate extends tumbler life



Prod No	Description	Disposable Lid	Glass Rack	Color	Pack
5105-2	147.87 ml PC Stackable Tumbler	DX1193ST8714*	RG16, RW20	07	24 ea
5108-2	236.59 ml PC Stackable Tumbler	—	RG36-1	07	24 ea
5109-2	280.95 ml PC Stackable Tumbler	5109L	RG25-1, RG36-1, RW30	07	24 ea
5116-2	487.96 ml PC Stackable Tumbler	DX22259000*	RG25-2, RW20-1	07, 10	24 ea
5120	591.47 ml PC Stackable Tumbler	DX30008714*	RG25-3, RW20-2	07	24 ea



*The DX Series Disposable Lids listed above are available through the Carlisle | Dinex Catalog

**Color available by special order only

Lafayette® 

- Distinctive fluted pattern has the look and style of glass
- Perfect for bar service, room service, or catered events
- Stacking lugs prevent jamming
- Slotted base allows complete draining



Prod No	Description	Disposable Lid	Glass Rack	Color	Pack
43633	236.59 ml Lafayette PC Tumbler	DX20029000*	RG36-1, RW30	07 (Clear)	36 ea
43635	295.74 ml Lafayette PC Tumbler	—	RG25-2, RW30-1	07 (Clear)	36 ea
43636	354.88 ml Lafayette PC Tumbler	—	RG25-2, RW20-1, RW30-1	07 (Clear)	36 ea
43637 **	354.88 ml Lafayette PC Old Fashioned Tumbler	DX21259000*	RG16-1, RG25-1, RW20	07 (Clear)	36 ea
43638	473.18 ml Lafayette PC Tumbler	DX21259000*	RG25-2, RW20-1	07 (Clear)	36 ea
43640	650.62 ml Lafayette PC Tumbler	—	RG16-3, RW20-2	07 (Clear)	36 ea

Swirl 

- Unique swirl design creates a perfect glass-like tabletop beverage presentation



Prod No	Description	Disposable Lid	Glass Rack	Color	Pack
43662	147.87 ml Swirl PC Tumbler	—	RG49-1	07 (Clear)	36 ea
43663	236.59 ml Swirl PC Tumbler	DX20029000*	RG36-1, RW30	07 (Clear)	36 ea
43664	266.16 ml Swirl PC Tumbler	—	RG25-1, RW20	07 (Clear)	36 ea
43665	295.74 ml Swirl PC Tumbler	—	RG25-2, RW30-1	07 (Clear)	36 ea
43666	354.88 ml Swirl PC Tumbler	—	RG25-2, RW20-1, RW30-1	07 (Clear)	36 ea
43668	473.18 ml Swirl PC Tumbler	—	RG16-2, RG25-2, RW20-1	07 (Clear)	36 ea
43674	650.62 ml Swirl PC Tumbler	—	RG16-3, RW20-2	07 (Clear)	36 ea

Note: *The DX Series Disposable Lids listed above are available through the Carlisle | Dinex Catalog

** Item available by special order only

CARAFES

Cascata Carafe



- Ergonomic shape is easy to hold and angled rim provides a drip-free pour
- Larger sizes can be used for water, juice or wine
- Smaller sizes are good for salad dressings, syrups, single-portion drinks and snack mix
- Durable polycarbonate looks like glass



Prod No	Description	Capacity Marks	Glass Rack	Color	Pack
70900	0.25 Liter Carafe	177.44 ml, 236.59 ml, 0.25L	RG25-2, RW30-1	Clear (07)	12 ea
70901	0.50 Liter Carafe	0.5L	RG16-3, RW20-2	Clear (07)	12 ea
70902	1 Liter Carafe	1.0L	RG16-5	Clear (07)	12 ea
70903	1.5 Liter Carafe	1.5L	—	Clear (07)	12 ea
70904	Flat Carafe Lid (fits 70901, 70902, 70903)	—	—	White (02)	12 ea
70905	Hinged Carafe Lid (fits 70901, 70902, 70903)	—	—	White (02)	12 ea



.47 Liter Carafe



- Durable SAN 312 ml capacity carafe is perfect for room service, hospitals, nursing homes, restaurants and cafeterias
- Ribbed neck and textured finish provide a better grip and greater safety than glass bottles

Prod No	Description	Capacity Marks	Glass Rack	Color	Pack
7000	325 ml Carafe	DX55-57*	RG16-2	Clear (07)	36 ea

MUGS

Lexington™ Polycarbonate Mug

- Heavy-weight mug offers traditional styling in durable polycarbonate
- Crystal clear mug has the look and feel of glass without the replacement
- Recessed drain for easy drying



Prod No	Description	Glass Rack	Color	Pack
43965	473.18 ml Lexington Mug	RG9-3	07	12 ea

Carlisle Mugs

- Made of break-resistant Tritan
- Specially designed, large handle allows for easy holding, keeps fingers away from hot liquids
- Safe for temperatures up to 190°F (88°C)



Prod No	Description	Disposable Lid	Glass Rack	Color	Pack
43066	236.59 ml Carlisle Mug	5109L	RG16-1	02, 03, 09, 14, 22, 42	12 ea
43068	354.88 ml Carlisle Mug	—	RG25-1, RW20	02, 03, 09, 14, 22, 42	12 ea

Coffee Mugs

- Rugged, chip and crack-resistant plastic to give you long wearing service
- Diablo mugs have double-wall construction to maintain hot temperatures longer
- Diablo II has single-wall construction for money-saving service



Prod No	Description	Glass Rack	Color	Pack
8004	236.59 ml, 10.49 cm Diablo Mug with White Liner	RG16-1	01, 02	36 ea
8104	236.59 ml, 10.49 cm Diablo II Mug	RG16-1	01	36 ea
4512	354.88 ml, 13.97 cm Jumbo Soup/Latté Mug	RG9, RTP	19, 28	24 ea

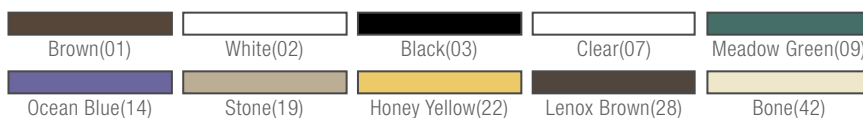

PITCHERS



VersaPour® Pitchers



- Lip design allows for easy pouring with ice from front or either side without splashing
- Sure grip ergonomic handle and thumb grip help control pouring
- Made of break-resistant polycarbonate for ultimate durability
- Thinner wall provides optimum strength and durability; reduces wait staff's wrist stress

Prod No	Description	Color	Pack
VERSAPOUR POLYCARBONATE PITCHERS			
5540	1774 ml VersaPour Pitcher	Clear (07), 13	6 ea
5544	1774 ml VersaPour Window Pitcher	Clear (07)	6 ea
VERSAPOUR SAN PITCHERS			
5546	1774 ml VersaPour Pitcher	Clear (07)	6 ea
5547	1774 ml VersaPour Window Pitcher	Clear (07)	6 ea

Amber(13)



Polycarbonate Pitchers



- Ice trap retains ice or beer foam
- Made of break-resistant polycarbonate for ultimate durability

Prod No	Description	Color	Pack
5536	946 ml Polycarbonate Pitcher	Clear (07)	6 ea
5538	1419 ml Polycarbonate Pitcher	Clear (07)	6 ea

Crystalite® Polycarbonate Pitchers



- Tapered lip permits controlled pouring of the beverage and ice
- Secure thumb hold on handle aids control of pitcher while pouring
- Slot at skirt base deters water collection
- Made of break-resistant polycarbonate for ultimate durability

Prod No	Description	Glass Rack	Color	Pack
5583	1419.53 ml Crystalite Pitcher	RF	07 (Clear)	6 ea
5587	1774.41 ml Crystalite Pitcher	RF	07 (Clear)	6 ea



Élan™ Polycarbonate Pitchers



- Thick walls and optic bottom gives these pitchers the look of glass
- Made of break-resistant polycarbonate
- Lid available separately

Prod No	Description	Glass Rack	Color	Pack
5570	1715.26 ml Élan Pitcher	RF	07 (Clear)	6 ea
5573	Clear Lid for Élan Pitcher	—	07 (Clear)	6 ea

Mingle



- The look and feel of recycled glass drinkware
- Tritan offers durability that withstands the heavy use in your venue
- Durable Tritan is break and craze-resistant
- Stain resistant

Prod No	Description	Color	Pack
MIN5443	2188.44 ml Pitcher	02, 15, 18	4 ea

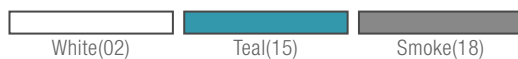



CARLISLE
FOODSERVICE PRODUCTS



TABLETOP ACCESSORIES

RAMEKINS



Straight Sided Ramekins



- Melamine ramekins are safe for temperatures up to 100°C
- A modern take on a traditional product
- Use for sauces, condiments and mini desserts
- Ramekins stack for easy storage and space savings

Prod No	Description	Color	Pack
410	57 ml Straight Sided Ramekin	02, 03, 42	48 ea
412	85 ml Straight Sided Ramekin	02, 03, 42	48 ea
414	113 ml Straight Sided Ramekin	02, 03, 42	48 ea



Oval Ramekins



- Heavy-weight melamine ramekins are perfect for sauces, condiments, finger foods, mini desserts, etc.
- Oval shape is great for pouring dressings and sauces
- Wide design makes dipping easier

Prod No	Description	Color	Pack
S310	57 ml Oval Ramekin	02, 03, 42	48 ea
S312	85 ml Oval Ramekin	02, 03, 42*	48 ea
S314	113 ml Oval Ramekin	02, 03, 42	48 ea

* Color available by special order only

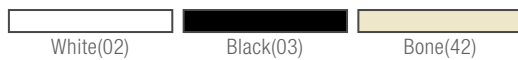

Square Melamine Ramekins



- Made of sturdy, break-resistant melamine
- 57 g square ramekins available in single and double sizes
- Ramekins are stackable and can be used as a set for a variety of dipping sauces or individually for soy sauce and other condiments
- Safe for temperatures up to 100°C

Prod No	Description	Color	Pack
0860	57 ml Square Ramekin	02, 03	48 ea
0862	Double 57 ml Square Ramekin	02, 03	24 ea





Japanese Style Ramekin



- Made of sturdy, break-resistant melamine
- 57 g ramekins are styled with an Asian flare
- Heavy-weight design has the look and feel of ceramic or glass
- Ramekins are stackable and can be used for wasabi, ginger or a variety of dipping sauces
- Safe for temperatures up to 100°C

Prod No	Description	Color	Pack
0864	57 ml Japanese Style Ramekin	02, 03	48 ea



Scalloped Melamine Ramekins



- Made of thick-walled, heavy-weight melamine
- Stylish design coordinates with our dinnerware and display pieces
- Serves sauces, butter, salad dressings, salsa, etc.

Prod No	Description	Color	Pack
43942	28 ml Scalloped Ramekin	02, 03*, 42	48 ea
43943	57 ml Scalloped Ramekin	02, 03, 42*	48 ea
43944	85 ml Scalloped Ramekin	02, 03	48 ea

* Color available by special order only

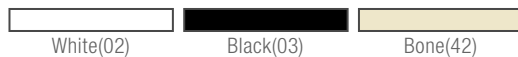

Melamine Butter Dish



- Ideal for small portions of butter, wasabi or other condiments
- Wide mouth gives the illusion of a larger portion
- Heavy-weight sides have the look and feel of ceramic or glass
- Unique look is perfect for both casual and upscale dining or even pre-portioning in buffet and catering applications

Prod No	Description	Color	Pack
0855	28 ml Melamine Butter Dish	02	48 ea





Melamine Ramekins



• Thick-walled, heavy-weight melamine is perfect for serving sauces, butter, salad dressing, salsa, etc.

Prod No	Description	Color	Pack
S277	49 ml Smooth Ramekin	42	48 ea
S275	42 ml Smooth Ramekin	02, 03, 09, 14, 22, 42, 52, 60	48 ea
0852	57 ml Smooth Ramekin	02, 03, 09, 14, 22, 42, 52, 58, 60, 69	72 ea
S280	85 ml Smooth Ramekin	02, 03, 42, 52, 58, 60, 69	48 ea
S285	113 ml Smooth Ramekin	02, 03, 09, 14, 22, 42, 52, 58, 60	48 ea
S286	170 ml Smooth Ramekin	02, 03, 42, 60, 69	48 ea
S279	57 ml Fluted Ramekin	02, 03, 42, 60	48 ea
S282	85 ml Fluted Ramekin	02, 03, 42, 60, 69	48 ea
S287	113 ml Fluted Ramekin	02, 03, 42, 60, 69	48 ea

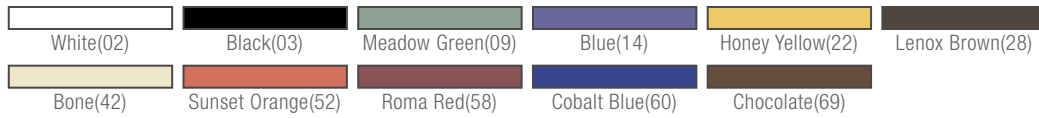

Salsa Dishes

- Carlisle salsa dishes are available in a variety of sizes, weights and materials
- Designed to accommodate dipping large chips or appetizers
- Deep salsa bowl has 226 g capacity, perfect for serving salsa, cheese sauce, soups and other sauces
- 0873, 0878, 0875: NSF Listed



Prod No	Description	Color	Pack
0873	85 ml Melamine Molcajete Ramekin	03	48 ea
0878	226 ml Melamine Molcajete Ramekin	03	48 ea
43125	141 ml SAN Salsa Dish	60	48 ea
4553	226 ml Melamine Deep Salsa Bowl	28	36 ea
0875	141 ml Melamine Salsa Dish	02, 03, 42, 60	48 ea





Ramekins & Sauce Cups

- Perfect for individual service of butter, salsa, condiments, sauce
- Made of durable, break-resistant SAN
- Available in four distinct styles
- 0362, 0843, 0844, 0845, 2500: NSF Listed

Prod No	Description	Color	Pack
0362	70 ml Standard Ramekin	02, 70, 28	48 ea
0843	28 ml Fluted Ramekin	02	48 ea
0844	57 ml Fluted Ramekin	02, 07	48 ea
0845	127 ml Fluted Ramekin	02, 07, 28	48 ea
2500	70 ml SAN Sauce Cup	07	72 ea
0820	77 ml Oyster Sauce Cup	07	144 ea
0830	28 ml Soufflé Cup	07	144 ea
0831	70 ml Soufflé Cup	07	144 ea



Stainless Steel Ramekin & Sauce Cup

- Rust-free, 18-8 stainless provides durable, easy care service



Prod No	Description	Pack
602400	42 ml Stainless Steel Classic Ramekin	144 ea
602500	70 ml Stainless Steel Classic Sauce Cup	144 ea

SAN Ramekins

- Economical SAN ramekins serve sauces, butter, salad dressings, salsa, etc.
- Stackable design for easier storage

Prod No	Description	Color	Pack
43121	42 ml Smooth Ramekin	42	48 ea
43122	57 ml Smooth Ramekin	03	48 ea
43123	85 ml Smooth Ramekin	03, 42	48 ea
43126	170 ml Smooth Ramekin	03, 42, 60	48 ea

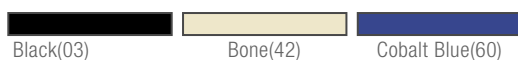

TORTILLA SERVERS

- Interlocking base & lid design allows for stacking several tortilla servers at one time



Tortilla Servers



- Lid has easy-grip, recessed handle
- Durable polycarbonate tortilla servers withstand temperatures up to 100°C
- Polypropylene servers are easy-clean, long-lasting and economical; withstand temperatures up to 87°C
- US Patent No. D-331351

Prod No	Description	Color	Pack
0470*	19 cm PC Tortilla Server	03, 05, 60	24 ea
0475*	19 cm PPY Tortilla Server	03, 05, 28, 42	24 ea



Salsa and Molcajete Dishes on previous page.

Aztec Tortilla Servers



- Unique Aztec design works well in any traditional Mexican or Tex-Mex restaurant
- 20 cm and 30 cm servers available in a lift off lid model
- 17 cm server available with hinged lid for easy one handed access
- Thick walled polypropylene material helps keep tortillas warm for table service
- Microwaveable, safe for temperatures up to 65°C
- Servers are stackable

Prod No	Description	Color	Pack
0710	17 cm Hinged Tortilla Server	03, 29	12 ea
0713	20 cm Lift Off Tortilla Server	03, 29	12 ea
0717	30 cm Lift Off Tortilla Server	03, 08, 29	6 ea
0700	17 cm Hinged Replacement Lid	03, 29	12 ea
0703	20 cm Replacement Lid	03, 08	12 ea
0707	30 cm Replacement Lid	03, 08, 29	6 ea





CARLISLE
FOODSERVICE PRODUCTS

MARKO

Classic Twill Skirting

- Minimal fading, shrinking and wrinkling
- 100% Polyester; machine wash and dry
- Flame retardant
- Shirred skirts come complete with hook and loop tape and 550PC clips

Prod No	Description	Dimensions	Color	Pack
5024CE29AF	Classic Twill Shirred Pleat Skirting w/Velcro Header & 24 Clips	42.65 m	010 (White), 014 (Black)	1 ea
5024EG29AF	Classic Twill Shirred Pleat Skirting w/Velcro Header & 31 Clips	57.41 m	010 (White), 014 (Black)	1 ea
5024FW29AF	Classic Twill Shirred Pleat Skirting w/Velcro Header & 38 Clips	68.9 m	010 (White), 014 (Black)	1 ea



White(010)



Black(014)

Clips

- Specifically designed clips to fit a variety of table edges
- Lifetime guarantee on metal clips

Prod No	Description	Table Edge	Pack
5CC55PC-12	Overlock & Valance Clip, Hook & Loop Header	1.27 cm	12 ea
5CC118MP-12	12 Metal Skirting Clip, Hook & Loop Header	0.95 cm - 3.18 cm	12 ea
5CC120MP-12	12 Metal Skirting Clip, Hook & Loop Header	3.18 cm - 5.72 cm	12 ea
5CC200PC-12	12 Plastic Skirting Clip, Hook & Loop Header	0.95 cm - 1.91 cm	12 ea
5CCCCLIP-12	12 Plastic Skirting Clip, Hook & Loop Header	1.91 cm - 5.08 cm	12 ea
5CCLCLIP-12	12 Large Plastic Skirting Clip, Hook & Loop Header	3.81 cm - 6.35 cm	12 ea



5CC55PC-12



5CC118MP-12



5CC120MP-12



5CC200PC-12



5CCCCLIP-12



5CCLCLIP-12



CARLISLE
FOODSERVICE PRODUCTS



DISPLAYWARE

MELAMINE DINNERWARE

- Maintains its appearance after one year of dishwasher testing
- Durable melamine is stain, scratch- and break-resistant, making it ideal for any foodservice operation
- Safe for temperatures up to 100°C



Balsam Displayware

Prod No	Description	Color	Pack
55520	2.54 cm Deep Full Size Pan	37*	6 ea
55522	6.35 cm Deep Full Size Pan	37	6 ea
55524	10.16 cm Deep Full Size Pan	37	6 ea
55526	2.54 cm Deep Half Long Size Pan	37	6 ea
55528	6.35 cm Deep Half Long Size Pan	37	6 ea
55530	10.16 cm Deep Half Long Size Pan	37	6 ea
55532	2.54 cm Deep Half Size Pan	37*	6 ea
55534	6.35 cm Deep Half Size Pan	37	6 ea
55536	10.16 cm Deep Half Size Pan	37	6 ea
55538	2.54 cm Deep Third Size Pan	37	6 ea
55540	6.35 cm Deep Third Size Pan	37	6 ea
55542	10.16 cm Deep Third Size Pan	37	6 ea
55544	737 ml Angled Bowl	37	6 ea
55546	2419 ml Angled Bowl	37	6 ea
55550	737 ml Square Bowl	37	6 ea

* Color available by special order only

Flared Square Bowls

- Large display bowls coordinate with many other Carlisle pieces
- High quality, heavy-weight melamine

Prod No	Description	Color	Pack
33360	4032 ml, 29.85 cm Small Flared Bowl	02, 03	4 ea
33362	6451 ml, 34.93 cm Medium Flared Bowl	02, 03	4 ea
33364	14668 ml, 42.88 cm Large Flared Bowl	02, 03	4 ea



Salad Bowl

- Made of dependable, impact-resistant melamine

Prod No	Description	Color	Pack
MELAMINE SALAD BOWLS			
1000B	1532 ml, 25.4 cm Bowl	03	6 ea



Rave® Displayware



- Offers the look and feel of china without the replacement cost
- Bowls lock into pedestal for secure serving

Prod No	Description	Color	Pack
33310	17.8 cm, 1209 ml Rave Serving Bowl	02, 03	6 ea
33312	25.4 cm, 3629 ml Rave Serving Bowl	02, 03	6 ea
33314	30.5 cm, 3629 ml Rave Salad Bowl	02, 03	6 ea
33316	33.02 cm, 1612.80 g Rave Starburst Bowl	02*, 03*	6 ea
33318	38.1 cm Rave Bowl with Rim	02*	6 ea
33320	25.4 cm, 2.37 L Rave Rectangular Platter	02	6 ea
33322	40.64 cm Rave Rectangular Platter	02, 03	6 ea
33324	58.42 cm Rave Rectangular Platter	02, 03	6 ea
33326	40.64 cm Rave Trapezoid Platter	02, 03*	6 ea
33302	10.16 cm Rave Pedestal	02*	12 ea

* Color available by special order only



Epicure® Displayware



Prod No	Description	Color	Pack
ARR240	1304 ml, 22.9 cm Round Open Vegetable Bowl	02	12 ea
5933	907 ml, 20.96 cm Round Bowl	02	24 ea
43737	680 ml, 18.75 cm Footed Serving Bowl	02, 03	12 ea
43738	1020 ml, 21.92 cm Footed Serving Bowl	02	12 ea
43739	57 oz, 23.50 cm Footed Serving Bowl	02	12 ea
43842	35.56 cm x 25.4 cm Oblong Platter	02, 03	12 ea



Narrow Rimmed Displayware



Prod No	Description	Color	Pack
NARROW RIMMED DISPLAYWARE			
ARR112	37.47 cm x 26.67 cm Oval Platter	02	12 ea
ARR120	30.5 cm x 21.59 cm Oval Platter	02, 25	12 ea
43745	794 ml, 25.4 cm x 19.05 cm Baker/Server	02, 25	12 ea
43840	53.34 cm x 38.1 cm Catering Platter	02, 03	6 ea
43772	39.37 cm x 26.67 cm Oblong Platter	02	12 ea



Palette Designer Displayware™



- Combine with decorated Palette pieces for attention getting displays in the deli case or buffet line
- Break-resistant construction reduces replacement costs
- High quality, heavy-weight melamine

Prod No	Description	Cover	Color	Pack
43024	30.5 cm Wide Rim Round Plate	1994*	02	12 ea
44400	30.5 cm Wide Rim Square Plate	44400C	02, 03	4 ea
44402	35.56 cm, 3629 ml Wide Rim Square Bowl	44402C	02, 03	4 ea
44404	38.1 cm Wide Rim Round Platter	44404C	02	4 ea
44406	48.26 cm Wide Rim Round Platter	—	02, 03	4 ea
44410	43.18 cm X 33.02 cm Wide Rim Oval Platter	44410C	02, 03	4 ea
44412	53.34 cm X 38.1 cm Wide Rim Oval Platter	44412C	02, 03	4 ea
44414	35.56 cm X 25.4 cm Wide Rim Rectangle Platter	44414C	02, 03	4 ea
44416	43.18 cm X 33.02 cm Wide Rim Rectangle Platter	—	02, 03	4 ea
44418	55.88 cm Wide Rim Salmon Platter	—	02, 03	4 ea

*1994 Plate Cover can be found on page 79.

Palette Designer Displayware™ Food Pans



- 6.35 cm and 10.16 cm deep pans can be turned over and used as display stands

Prod No	Description	Cover	Color	Pack
44420	2.54 cm D Full Size Food Pan, 52.71 cm x 32.39 cm	—	02, 03	6 ea
44422	6.35 cm D Full Size Food Pan, 52.71 cm x 32.39 cm	—	02, 03	6 ea
44430	2.54 cm D Half Size Food Pan, 32.39 cm x 26.37 cm	44432C	02	6 ea
44432	6.35 cm D Half Size Food Pan, 32.39 cm x 26.37 cm	44432C	02	6 ea
44460	2.54 cm D Third Size Food Pan, 32.39 cm x 17.45 cm	—	02, 03	6 ea
44462	6.35 cm D Third Size Food Pan, 32.39 cm x 17.45 cm	—	02	6 ea



44410C Lid with 44410



44414C Lid with 44414

Palette Designer Displayware™ Covers



- Clear polycarbonate covers are highly heat- and break-resistant
- Allows you to safely protect and transport dishes prepped in advance
- Stack for compact storage

Prod No	Description	Color	Pack
44410C	Cover for 43.18 cm x 33.02 cm Wide Rim Oval Platter	07	12 ea
44414C	Cover for 35.56 cm x 25.4 cm Wide Rim Rectangle Platter	07	12 ea
44432C	Cover for Half Size Food Pan	07	12 ea

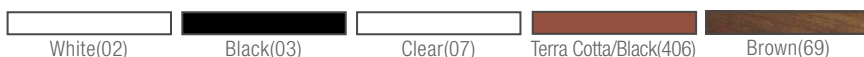

Epicure® Acacia Wood Grain  

- Durable Material is made of sturdy, break resistant melamine
- Look of organic acacia wood without the need to handwash or season
- Buyer's assurance with a limited warranty against breakage
- Large selection to fit every serving need from Dip Bowls to 45.72 cm Round platters

Prod No	Description	Color	Pack
EAG01	19.05 cm, 34 oz Small Bowl	69	12 ea
EAG02	30.5 cm, 3870.72 g Serving Bowl	69	6 ea
EAG04	45.72 cm x 38.1 cm Oval Platter	69	6 ea
EAG05	35.25 cm x 19.69 cm Rectangular Tray	69	12 ea
EAG06	45.72 cm Round Platter	69	6 ea
EAG07	37.47 cm x 17.15 cm Rectangular Tray	69	12 ea
EAG08	11 cm, 141.75 g Dip Bowl	69	12 ea
EAG09	34 cm Flight Tray	69	6 ea
EAG10	49 cm Round Platter	69	2 ea
EAG11	22.86 cm Square Tray	69	12 ea



EAG09 Flight Tray & EAG08 Dip Bowls



Designer Displayware®  

- Heavy, china/ceramic feel and look without the breakage
- Perfect for salads and entrées in family style dining, banquets, buffets or deli display cases

Prod No	Description	Color	Pack
7910	2.27 kg, 26.67 cm Designer Pasta Bowl	02, 03	4 ea
7913	4.54 kg, 33.02 cm Designer Pasta Bowl	02, 03	4 ea
7914	1613 ml, 35.56 cm x 25.4 cm Oval Designer Platter	02, 03	4 ea
7916	2419 ml, 40.64 cm x 30.5 cm Oval Designer Platter	02, 03	4 ea
7918	3226 ml, 48.26 cm x 34.93 cm Oval Designer Platter	02, 03	4 ea
7919	2.74 L, 22.86 cm x 30.5 cm Designer Baker	02, 03	4 ea
7920	3226 ml, 25.4 cm x 35.56 cm Designer Baker	02, 03	4 ea
8919	2.74 L, 22.86 cm x 30.5 cm Mosaic Baker	406*	4 ea
8920	3226 ml, 25.4 cm x 35.56 cm Mosaic Baker	406	4 ea

* Color available by special order only



MODULAR DISPLAYWARE



- Wave shape offers visual interest while enhancing the display
- Unique, flexible displayware provides an attractive solution for merchandising prepared food
- Fits in standard size food wells
- Half long lid can be used as a display tray for sliced deli meats and cheeses
- Made of tough, break-resistant polycarbonate
- Safe for use in temperatures ranging from -40° to 100°C

Prod No	Description	Color	Pack
6982	3588 ml Half Long Pan - Wavy Edge	03, 07*	6 ea
6990	3588 ml Half Long Pan - Straight Edge	03	6 ea
6982L	Half Long Lid	07	6 ea
6988	Half Long Collar	03	6 ea
6984	1560 ml, 6.35 cm Deep Half Size Pan	03	6 ea
69844	2220 ml, 10.16 cm Deep Half Size Pan	03	6 ea
69846	3120 ml, 15.24 cm Deep Half Size Pan	03	6 ea
6984L	Half Size Lid	07	6 ea
6986	960 ml, 6.35 cm Deep Third Size Pan	03	6 ea
69864	1344 ml, 10.16 cm Deep Third Size Pan	03	6 ea
69866	1872 ml, 15.24 cm Deep Third Size Pan	03	6 ea

* Color available by special order only



Collar provides support for smaller pans when used in a food well



SPECIALTY TRAYS

Fiberglass Market Trays and Pans

- Use for displaying breads, bakery items and sliced deli meat
- 5.08 cm deep pans for serving deli salads, pasta and desserts
- Trays have heavy-duty fiberglass construction and metal reinforced rods
- Air-flow corners reduce drying time



Prod No	Description	Color	Pack
FIBERGLASS MARKET TRAYS			
630FMT	30.00/6.44/0.75	309*	12 ea
830FMT	30.00/8.50/0.75 Tray	301, 309	12 ea
1030FMT	30.00/10.44/0.75 Tray	301, 309	12 ea
1230FMT	30.00/12.44/1.05 Tray	301, 309	12 ea
269FMT	8.75/25.50/1.12 Tray	301, 309	12 ea
1218FMT	17.75/11.44/0.75 Tray	301, 309	12 ea
1318FMT	17.75/12.75/1.00 Tray	301, 309	12 ea
2618FMTQ	17.87/25.62/1.25 Tray	301, 302, 303, 304, 306, 309	6 ea
FIBERGLASS MARKET PANS			
6302FMT	30.00/6.45/2.00 Pan	301, 309	12 ea
8302FMT	30.00/8.45/2.00 Pan	301, 309	12 ea
10302FMT	30.00/10.47/2.00 Pan	301, 309	12 ea

BOX INDICATES ITEM IS AVAILABLE FOR IMMEDIATE SHIPMENT IN OUR MOST POPULAR SIZES

* Color available by special order only



Festival Trays™

- Beautiful alternative to glass, crystal, or disposables
- Molded-in pattern gives the appearance of fine etched crystal
- Economical, break-resistant SAN resists food acids and oils
- Safe in temperatures from -17.7° to 82°C



Prod No	Description	Color	Pack
FESTIVAL TRAYS			
6413	33.02 cm Round Tray	07	12 ea
6416	40.64 cm Round Tray	07	12 ea
6417	31.75 cm x 17.78 cm Rectangular Tray	07	12 ea
6450	38.1 cm x 27.31 cm Rectangular Tray	07	12 ea
6426	55.88 cm x 40.64 cm Handled Tray	07	6 ea
6439	33.02 cm x 49.53 cm Handled Tray	07	6 ea
TRAY STANDS			
C3625T	91.44 cm Tall Steel Stand	38	6 ea
C3620W	76.2 cm Wood Stand	11	6 ea
C3630W	77.47 cm Plastic Stand	11	6 ea



COVERS



PSD21EH



PSD21DEH

Display Covers

- Covers enhance and protect the look of your food items; helps keep food fresh
- Use for merchandising fresh fruits, desserts, salads, sandwiches or bakery items
- Polycarbonate dome covers add increased durability and can be used in more extreme foodservice applications

Prod No	Description	Color	Pack
PSD13EH	30.5 cm x 25.4 cm End Cut Display Cover	Clear	1 ea
PSD13CH	30.5 cm x 25.4 cm Center Cut Display Cover	Clear	1 ea
PSD21EH	30.5 cm x 50.8 cm End Cut Display Cover	Clear	1 ea
PSD21CH	30.5 cm x 50.8 cm Center Cut Display Cover (20 cm x 17.15 cm opening)	Clear	1 ea
PSD21DEH	30.5 cm x 50.8 cm Double End Cut Display Cover	Clear	1 ea



PSD13EH



PSD13CH



PSD21CH



2512

3004



SC32

Cake Tray and Covers

- Clear covers display desserts and pastries
- Sanitary covers help keep foods fresher longer

Prod No	Description	Color	Pack
SC32	30.5 cm x 15.24 cm Cake Cover, Acrylic	Clear	6 ea
2512	30.5 cm x 16.5 cm Cake Cover, SAN	Clear	6 ea
3004	35.56 cm Display Tray, SAN	Clear	12 ea

SERVINGWARE

Terra™ Stainless Steel Serveware **NEW**

- Contemporary finish of hammered steel styling creates a rustic, urban-luxury aesthetic
- Versatile and subtle styling complements existing serveware
- Durable metal is forged from 18/0, 430 grade stainless steel for a superior lifespan
- Weight balanced design allows for easy holding/gripping
- Towel dry recommended

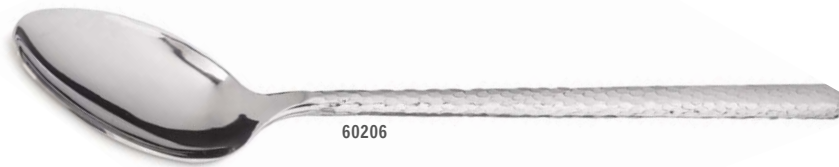

Prod No	Description	Pack
60200	30.5 cm Solid Serving Spoon	12 ea
60201	30.5 cm Slotted Serving Spoon	12 ea
60202	30.5 cm Cold Meat Fork	12 ea
60203	34.29 cm Ladle	12 ea
60204	30.5 cm Pie Server	12 ea
60205	25.4 cm Solid Spoon	12 ea

Prod No	Description	Pack
60206	24.13 cm Solid Spoon	12 ea
60207	27.94 cm Cake Server	12 ea
60208	22.23 cm Ladle	12 ea
60209	17.8 cm Tong	12 ea
60210	25.4 cm Tong	12 ea
60211	30.5 cm Tong	12 ea





CARLISLE
FOODSERVICE PRODUCTS



CONVENIENCE PRODUCTS

COLDMASTER®

Coldmaster® CoolCheck™

- Patent-pending technology allows you to quickly see when temperatures are no longer safe
 - Same great features as our standard Coldmaster products with the added element of color-changing technology
 - Unit holds food safely below 5°C for 6-8 hours*
 - Reduces waste by “telling” workers when food temperature is safe
- *Time will vary based on ambient room temperature



Prod No	Description	Color	Pack
CM1100C14	15.24 cm Deep Full-size Food Pan	02 (White)	1 ea
CM1101C14	15.24 cm Deep Half-size Food Pan	02 (White)	1 ea
CM1102C14	15.24 cm Deep Third-size Food Pan	02 (White)	1 ea
CM1103C14	15.24 cm Deep Third-size Divided Food Pan	02 (White)	1 ea
CM1104C14	15.24 cm Deep Sixth-size Food Pan	02 (White)	1 ea
CM1105C14	15.24 cm Deep High Capacity Sixth-size Food Pan	02 (White)	1 ea



THE COLDMASTER SOLUTION:

- High-impact ABS plastic holds up to foodservice use
- Exclusive refrigerant gel ensures high performance
Non-toxic gel receives a cold “charge” when frozen overnight, which enables it to keep your food cold throughout the day
- Extra insulation surrounds refrigerant gel for maximum cold retention
- Refrigerant gel is enclosed in a bag; prevents leaks, even if shell is damaged

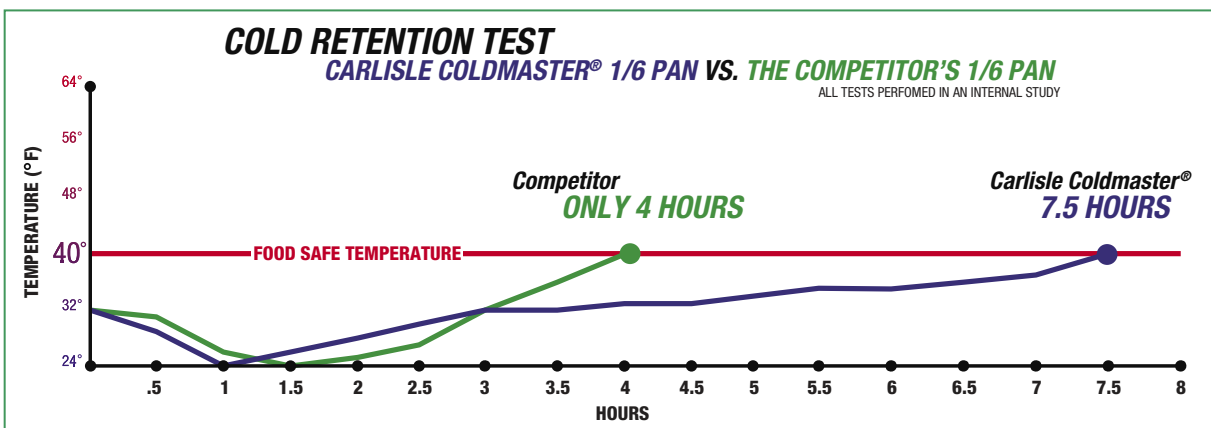

• Temperature retention is based on Coldmaster being pre frozen for a minimum of eight hours, then filled directly with pre-chilled foods. Testing was conducted under ambient room temperatures of 24°C

Coldmaster® Whipped Cream & 0.95 Liter Carton Chillers



- Chillers use the same technology as standard Coldmaster pans
- CM1107 is designed to hold a standard 0.95 L carton; keeps dairy/egg cartons cold up to 8 hours**
- CM1108 is designed to hold a whipped cream can and provide food-safe chilling for up to 8 hours**



Prod No	Description	Color	Pack
CM1107	0.95 L Carton Chiller	02, 03	1 ea
CM1108	Whipped Cream Can Chiller	02, 03	1 ea

**Temperature retention is based on crocks being pre-frozen for a minimum of eight hours, then filled directly with pre-chilled foods. Testing was conducted under ambient room temperatures of 76°F.

Standard Food Pans & Lids



- Designed to fit in standard sized food pan templates
- Save time and labor by placing food directly into Coldmaster Standard Pans
- Clear acrylic lid protects against contaminants
- Lids have molded-in handle that allows easy removal



Prod No	Description	Color	Pack
CM1100	15.24 cm Deep Full-size Food Pan	02, 03	1 ea
CM1101	15.24 cm Deep Half-size Food Pan	02, 03	1 ea
CM1102	15.24 cm Deep Third-size Food Pan	02, 03	1 ea
CM1103	15.24 cm Deep Third-size Divided Food Pan	02, 03	1 ea
CM1104	15.24 cm Deep Sixth-size Food Pan	02, 03	1 ea
CM1105	15.24 cm Deep High Capacity Sixth-size Food Pan	02, 03	1 ea
CM1125	Full-size Coldmaster Lid	07	2 ea
CM1126	Half-size Coldmaster Lid	07	2 ea
CM1127	Third-size Coldmaster Lid	07	2 ea
CM1128	Sixth-size Coldmaster Lid	07	2 ea



COLDMASTER®

Coldmaster EZ Access Lids



- Snug fit ensures they won't pop off, even when leveling a measure miser on the sidewall
- Innovative design includes lipped notches that allow the lid to be opened with a simple flick of the wrist or serving utensil
- Raised design allows maximum fill of your food pan
- Convenient hang hole for easy storage when not in use



Prod No	Description	Color	Pack
CM10238Z	1/2 Size Lid	07 (Clear)	2 ea
CM10239Z	1/2 Size Lid with Notch	07 (Clear)	2 ea
CM10240Z	1/2 Size Lid with 2 Notches	07 (Clear)	2 ea
CM10278Z	1/3 Size Lid	07 (Clear)	2 ea
CM10279Z	1/3 Size Lid with Notch	07 (Clear)	2 ea
CM10280Z	1/3 Size Lid with 2 Notches	07 (Clear)	2 ea
CM10318Z	1/6 Size Lid	07 (Clear)	2 ea
CM10319Z	1/6 Size Lid with Notch	07 (Clear)	2 ea



CM1049

Coldmaster Coldpans



- Designed with the same capacity as traditional style food pans
- Holds and keeps standard food pans cold
- CM1049 Pan Organizer is a 15.24 cm deep full size coldpan designed to hold (9) ninth-size food pans for easy organization





Prod No	Description	Color	Pack
COLDMASTER COLDPANS			
CM1042	15.24 cm Deep Full-size Coldpan (will hold full, third or half size pans)	02, 03	1 ea
CM1040	10.16 cm Deep Full-size Coldpan (will hold full, third or half size pans)	02	1 ea
CM1042LP	Full Size Coldpan Lid (fits CM1040, CM1042 and CM1049)	02	1 ea
CM1043	15.24 cm Deep Half-size Long Coldpan (will hold 1 half-long pan)	02	1 ea
CM1045	15.24 cm Deep Third-size Coldpan (will hold third, sixth or ninth size pans)	02	1 ea
CM1046	15.24 cm Deep Two-Thirds size Coldpan (will hold two-third or third size pans)	02	1 ea
COLDMASTER PAN/ORGANIZER			
CM1049	15.24 cm Deep Full-size Coldpan with Organizer (does not include food pans)	02	1 ea



DESIGNER COLDMASTER®

- High-impact ABS material
- Holds food temperatures at or below the ServSafe®** temperature of 4°C for up to four hours†
- Keeps salads fresh and crisp for hours



Designer Coldmaster  







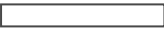

Prod No	Description	Color	Pack
DESIGNER COLDMASTER – STOCKED			
CM1400	0.95 L Flared Square	02, 03, 440, 444	1 ea
CM1401	1.89 L Flared Square	02, 03, 440, 444	1 ea
CM1402	4.73 L Oval	02, 03, 440, 444	1 ea
DESIGNER COLDMASTER – SPECIAL ORDER*			
CM1400	0.95 L Flared Square	439, 441, 442, 443	1 ea
CM1401	1.89 L Flared Square	439, 441, 442, 443	1 ea
CM1402	4.73 L Oval	439, 441, 442, 443	1 ea
DESIGNER COLDMASTER LIDS			
CM1403	0.95 L Lid Solid (fits CM1400)	07 (Clear)	1 ea
CM1404	0.95 L Lid Notched (fits CM1400)	07 (Clear)	1 ea
CM1405	1.89 L Lid Solid (fits CM1401)	07 (Clear)	1 ea
CM1406	1.89 L Lid Notched (fits CM1401)	07 (Clear)	1 ea
CM1407	4.73 L Lid Solid (fits CM1402)	07 (Clear)	1 ea
CM1408	4.73 L Lid Notched (fits CM1402)	07 (Clear)	1 ea

Ice Cream Servers

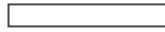

Prod No	Description	Color	Pack
CM1012	11.36 L Coldmaster Ice Cream Server	02, 03	1 ea
CM1013	Lid for Coldmaster Ice Cream Server	07 (Clear)	1 ea
38655	Coldmaster Ice Cream Shroud	—	1 ea



				
White/White(02)	Black/Black(03)	Clear(07) Lids Only	White/Pewter(440)	Black/Charcoal(444)
				
White/Champagne(439)*	White/Charcoal(441)*	Black/Champagne(442)*	Black/Pewter(443)*	

*Special order colors require a MOQ of 400 pieces and 3 weeks lead time for production.

**ServSafe® is a registered trademark of the National Restaurant Association

† Temperature retention is based on Coldmaster being pre-frozen for a minimum of eight hours, then filled directly with pre-chilled foods. Testing was conducted under ambient room temperatures of 76°F

CROCKS

- Translucent snap-on lids included

Classic Crock



- Thick-walled, heavy-weight design; made of SAN
- Chemical resistance to food acids and dressings
- High-gloss finish is extremely scuff-resistant
- -18°C to 82°C temperature range

Prod No	Description	Color	Pack
0300	0.57 L Classic Crock with Lid	03	12 ea
0301	1.14 L Classic Crock with Lid	01, 02, 03, 06, 07	12 ea
0316	1.42 L Classic Crock with Lid	01, 03, 06, 07	6 ea
0302	2.56 L Classic Crock with Lid	01, 02, 03, 06, 07	6 ea
0304	3.79 L Classic Crock with Lid	03	6 ea



Poly-Tuf™ Crock



- Optimum wall design gives greater break-resistance
- Glossy-finish crocks resist chipping and cracking
- Withstands temperatures from 0°C to 82°C

Prod No	Description	Color	Pack
POLY-TUF CROCKS			
0341	1.14 L Poly-Tuf Crock with Lid	01, 03, 06	12 ea
0343	1.42 L Poly-Tuf Crock with Lid	01, 03, 06	6 ea
0342	2.56 L Poly-Tuf Crock with Lid	01, 03, 06	6 ea

Replacement Lids



- For Classic & Poly-Tuf Crock

Prod No	Description	Color	Pack
0311	Lid - 0.57/1.14 L (fits 0300, 0301, 0341)	30	12 ea
0202	Lid - 1.42/2.56 L (fits 0302, 0316, 0342, 0343)	30	6 ea
0602	Lid - 3.79 L (fits 0304)	30	12 ea



TONGS

Carly® Tongs



- Carries a two-year limited warranty
- Withstands heat up to 100°C

Prod No	Description	Color	Pack
4606	15.24 cm Carly Salad Tong	01, 02, 03, 05, 06	12 ea
4609	22.86 cm Carly Salad Tong	01, 02, 03, 05, 06, 08	12 ea
4709	22.86 cm Carly Utility Tong	01, 02, 03, 05, 06, 08	12 ea
4712	30.48 cm Carly Utility Tong	01, 02, 03, 05, 06	12 ea
4806	15.24 cm Carly Pom Tong	01, 03, 06	12 ea
4006	15.24 cm Clear Carly Salad Tong	07	12 ea
4009	22.86 cm Clear Carly Salad Tong	07	12 ea
4109	22.86 cm Clear Carly Utility Tong	07	12 ea
4206	15.24 cm Clear Carly Pom Tong	07	12 ea



SERVING UTENSILS

Carly and Standard Ladles



- Two-year limited warranty
- Carly Ladle: 28.35 grams, oval-shaped bowl allows pouring from both sides
- Standard Ladle: 21.26 grams bowl with spouts on each side for easy pouring

Prod No	Description	Color	Pack
0295	24.13 cm Carly Ladle	01, 02, 03, 05, 06, 07	12 ea
0296	34.29 cm Carly Ladle	03	12 ea
0287*	24.13 cm Carly Ladle (Assorted Imprinted)	03	1 set
0240	26.67 cm Standard Ladle	03, 07	48 ea
0261*	26.67 cm Standard Ladle (Assorted Imprinted)	03	1 set



Serving Spoons, Buffet Spoons & Pasta Forks



- Two-year limited warranty
- Recommended for temperatures up to 100°C
- Withstands dry heat up to 132°C
- Serving Spoons have notch in handle so spoon can rest on edge of food pan

Prod No	Description	Color	Pack
4410	27.94 cm Solid Serving Spoon	02, 03, 05, 06, 07, 08	12 ea
4411	27.94 cm Perforated Serving Spoon	03, 07	12 ea
4420	33.02 cm Solid Serving Spoon	02, 03, 05, 06, 07	12 ea
4421	33.02 cm Perforated Serving Spoon	03	12 ea
4430	38.1 cm Solid Serving Spoon	03, 07	12 ea
4431	38.1 cm Perforated Serving Spoon	03	12 ea
4450	37 ml, 20.32 cm Solid Buffet Spoon	03, 06, 07	12 ea
4460	15 ml, 20.32 cm Solid Buffet Spoon	01, 02, 03, 05, 06, 07, 08	12 ea
4470	21 ml, 25.4 cm Solid Buffet Spoon	01, 03, 05, 06, 07	12 ea
4471	21 ml, 25.4 cm Perforated Buffet Spoon	01, 03, 06	12 ea
4355	24.13 cm Pasta Fork	03	12 ea



Salad Spoons



- Large flat edge for easy scooping
- 18.42 cm handle for easy reach
- Durable SAN material

Prod No	Description	Color	Pack
509	27.94 cm Salad Spoon	01, 03	48 ea



CUP & LID DISPENSERS



Adjustable Cup Dispensers

- One dispenser to fit all standard sizes of foam, paper or plastic drink cups from 226.8 to 1360.78 ml
- Vertical Cabinet Models are made of rugged stainless steel
- Spring-loaded with silicone release gaskets
- Comes with four interchangeable gaskets per tube (small, medium, large and extra large)
- No tools required; ready to use

Prod No	Description	Pack
38882G	0.48 L Dispenser, Vertical Cabinet Model	1 ea
38883G	0.72 L Dispenser, Vertical Cabinet Model	1 ea
38884G	0.96 L Dispenser, Vertical Cabinet Model	1 ea
38850GEW	Cup Dispenser only	1 ea

Gravity Feed Cup Dispensers

- Adjusts easily to fit various sizes of foam, paper or plastic cups
- Mounts on walls and includes 2-piece quick-release side mount bracket

Prod No	Description	Pack
38820C	Small Cup Dispenser, holds 170.1-312 ml, 6.35 - 8.74 cm cups	1 ea
38830C	Large Cup Dispenser, holds 340.19-680 ml, 8.59 – 9.86 cm cups	1 ea

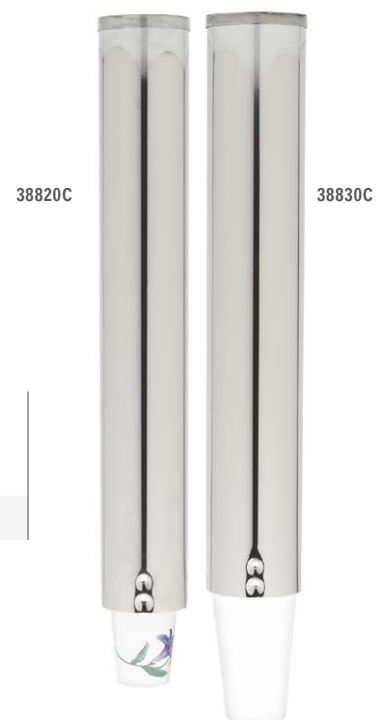



Lid & Condiment Organizer

- Stainless Steel Organizer mounts on top of Vertical Cup Dispenser Cabinets or can be used on counter tops
- Rubber feet prevent slipping and protect counter
- Includes 946.35 ml & 1.89 L plastic inserts

Prod No	Description	Pack
38800GLC*	Lid/Condiment Organizer	1 ea

Counter Top Lid & Straw Dispenser

- Dividers adjust to accommodate all standard size lids
- Straw panel is removable for additional lid storage
- Rubber feet protect counter tops
- Dispenser can be wall mounted on two standard key-lock holes



Prod No	Description	Pack
388804L	4 Station Counter Dispenser	1 ea



CARLISLE
FOODSERVICE PRODUCTS



BAR SUPPLIES

MAXIMIZER™ PORTABLE BAR

- Maximizer offers all the style and features you expect in a premium bar at a very affordable price
- Large 142 cm serving area keeps condiment caddies within reach without blocking prep area
- Ergonomic 2-step bar and countertop is designed for ease of drink preparation and serving
- Durable solidly molded countertop is easy to clean and includes a convenient molded-in bar mat well
- Sturdy 12 cm non-marking swivel casters with locking brake on each end hold the bar securely in place during use
- 3.7 L ice bin features an integrated drain and water trap
- Ice bin includes a standard dust cover for sanitary storage and transport
- Fully assembled, no tools necessary
- Find replacement parts at www.carlislefsp.com/replacement-parts

Prod No	Description	Color	Pack
7550	Maximizer Portable Bar	03, 44, 094	1 ea



Maximizer Portable Bar Cover

- Protective 8 gauge vinyl cover keeps bar clean and dry when not in use
- Double vented back secures with hook and loop tape for a custom fit
- Tape fastening allows easy access to bar storage area without removing cover

Prod No	Description	Color	Pack
7555	Maximizer Portable Bar Cover	80	1 ea



Designed by bartenders, Maximizer Portable Bar's upscale styling fits in any setting to enable profitable, efficient bar offerings that delight your guests with their favorite libations.



Maximizer Portable Bar's upscale styling is at home in any setting



Built in cutting board for easy condiment preparation; can be removed for thorough cleaning



Storage compartment includes mold-in rails; use with StorPlus™ 30 cm x 45 cm Food Storage Boxes



Includes standard 56 cm Stainless Steel Speed-Rak™; holds 6 bottles or 6 Store 'N Pour® 0.95 liter containers



Unique sliding storage drawer accommodates mixers, sodas or standard bus boxes and can be removed for more versatile storage



Large storage area under the drawer is perfect for staging glassware using our OptiClean™ Glass Racks



Durable Maximizer Portable Bar is perfect for outdoor service

STORE 'N POUR®

Store'N Pour

- Enjoy the benefits of the most efficient storing and pouring system for the bar, kitchen or dining room
- Pour a perfect 2-1 drink every time with the patented vented spout design
- Two-piece spout and neck design for easy cleaning
- Made of high density, break-resistant polyethylene
- Easy clean containers have straight wall design with no sharp interior edges that can collect food or bacteria
- Unique stacking ridge on 0.95 liter and 1/2 liter caps make storage on shelf in refrigerator easy and secure
- Color-coordinated spouts and caps for easy product identification
- Lids snap on exclusive, recessed base of 1/2 liter and 0.95 liter to prevent loss
- Assorted cap colors promote color-coding

Prod No	Description	Color	Pack
3042	Speed Spout	07 (Clear)	24 ea

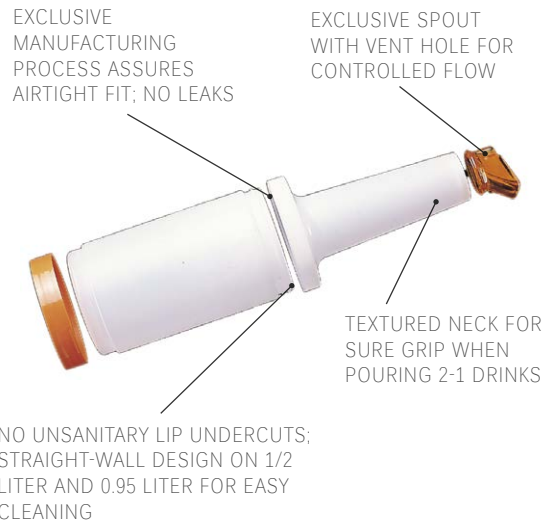

PourPlus Complete

- Unit includes container, lid and spout

Prod No	Description	Color	Pack
PS601NC	0.95 Liter Complete	Assorted (00), White (02)	12 ea

PourPlus Spout

- Fits all Store 'N Pour containers
- Integrated neck and spout designed for fast, free flowing pouring and easy clean-up
- Textured neck provides sure grip—even when wet
- Necks are color-coded

Prod No	Description	Color	Pack
PS204	PourPlus Spout	02 (White) 03 (Black)	12 ea
PS204AST*	PourPlus Spout, Assorted	00 (Assorted)	1 set

*Assorted PourPlus 0.95 liter packs include 2 each of all colors; 1.9 liter and 3.8 liter assorted packs includes 1 each of all colors



Store 'N Pour Versatility



Store 'N Pour Complete Units & Backups



- Complete unit includes neck and container plus color-coordinated pouring spout and cap
- Backup unit includes cap and container



Prod No	Description		
PS501N	1/2 Liter Complete	00	12 ea
PS502N	1/2 Liter Backup	00	12 ea
PS601N	0.95 Liter Complete	00, 01, 02, 04, 05, 09, 24	12 ea
PS602N	0.95 Liter Backup	00, 02, 04, 05, 09, 24	12 ea
PS701B	1.9 Liter Complete	00	6 ea
PS702	1.9 Liter Backup	00	6 ea
PS801B	3.8 Liter Complete	00	6 ea
PS802	3.8 Liter Backup	00	6 ea
PS103	Spouts, Specify Color	01, 04, 05, 07, 24	12 ea
PS103AT	Spout Assortment, 2 ea color	00	12 ea
PS203	Necks	02	12 ea
PS304	Caps, Specify Color	01, 02, 03, 04, 05, 24	12 ea
PS304AT	Caps, Assortment 2 ea color	00	12 ea
PS603N	0.95 Liter, Container Only	02	12 ea



Store 'N Pour Speed Spout

- No-drip spout is vented to promote faster, more even flow

Prod No	Description	Color	Pack
3042	Speed Spout	07 (Clear)	24 ea

Store 'N Pour Bar Service Pack

- Includes six 0.95 liter complete units (container, neck and color-coordinated spout and cap), 18-0.95 liter backup units (container and cap) and 3.8 liter backup unit (container with cap) for mixing

Prod No	Description	Color	Pack
PS6012	Store 'N Pour Bar Service Pack	00 (Assorted)	1 set



BAR ACCESSORIES

Glass Rimmers

- Two-tier unit provides consistent and even coat of salt
- Three-tier unit allows for application of either salt or sugar

Prod No	Description	Color	Pack
GR09	3-Tier Glass Rimmer	03 (Black)	12 ea
GR10	2-Tier Glass Rimmer	03 (Black)	12 ea



Portion Pour®

- Portion Pour dispenses exact shots of liquor from 1 to 1.5 ounce
- Also available in 20ml metric size
- Dispenses exact shots of liquor

Prod No	Description	Color	Pack
EP214	29.57 ml Portion Pour with Red Base	00 (Standard)	12 ea
EP216	36.97 ml Portion Pour with Clear Base	00 (Standard)	12 ea
EP217	44.36 ml Portion Pour with Yellow Base	00 (Standard)	12 ea

Pour Free®

- Economical Pour Free for free-flow pouring

Prod No	Description	Color	Pack
OP305	Fluorescent Red Pour Free	00 (Standard)	12 ea
OP316	Black Pour Free	00	12 ea
OP371	Chrome/Black Collar Pour Free	00	12 ea





Free Flowing Metal Liquor Pourers

- Sturdy metal construction and choice of three flow rates
- Chrome plated for attractive appearance and longer life
- Sanitary screen on WPM25

Prod No	Description	Color	Pack
WPM25	Chrome Tapered with Screen	38	12 ea
WPM85	Chrome Tapered, Medium Flow	38	12 ea
WPM45	Chrome Angled, Super Fast Flow	38	12 ea

Chrome(38)



Ice Scoops



- 606106 scoop is made of 18-8 rust-free mirror polished stainless steel
- 4306 is made of durable polycarbonate material for long lasting use
- Tapered for easy pouring of ice into glasses
- Both feature a hole for hanging or tying to a container
- Made of durable polycarbonate material for long-lasting use

Prod No	Description	Color	Pack
606106	177.44 ml Stainless Steel Bar Scoop	—	24 ea
4306	177.44 ml Polycarbonate Scoop	07 (Clear)	12 ea



CARLISLE
FOODSERVICE PRODUCTS



FOODSERVICE TRAYS

FIBERGLASS TRAYS

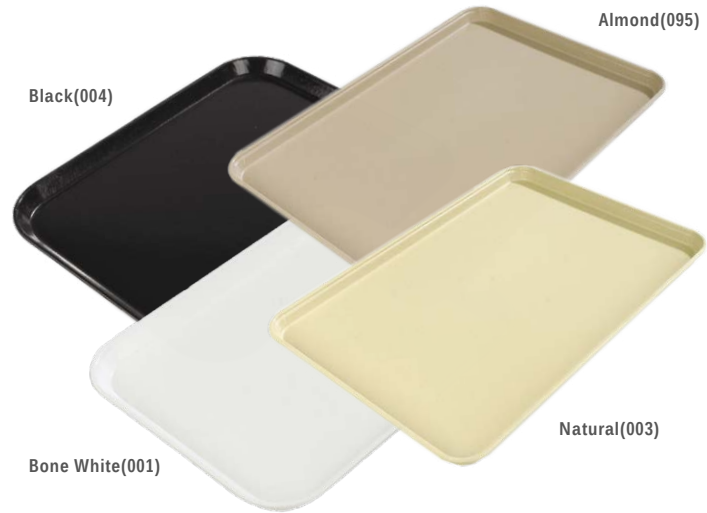

Glasteel™ Trays



- Engineered to be the most durable fiberglass trays available
- Metal reinforcing rods provide extra strength and eliminate warping
- Two thick, reinforcing fiberglass core mats add strength and provide increased chemical resistance
- Air flow corner reinforcements and stacking lugs make Glasteel trays your best choice for stability and drying when stacked
- Unique design permits air flow to all surfaces of stacked trays, reducing drying time

Fiberglass Trays are available in full cases only.

There is a NO-RETURN POLICY on Customized Fiberglass Trays.

Prod No			Description	Pack
Solid Color	Decorative Pattern	Wood Grain		
RECTANGULAR				
1410FG	1410DFG	1410WFG	34.93/26.97/1.91 cm	12 ea
1612FG	1612DFG	1612WFG	41.58/30.48/1.91 cm	12 ea
1814FG	1814DFG	1814WFG	45.72/35.56/1.91 cm	12 ea
2015FG	2015DFG	2015WFG	51.44/38.1/1.91 cm	12 ea
2216FGQ	—	2216WFGQ	56.18/40.64/2.67 cm	6 ea
LOW EDGE				
1216LFG	1216LDFG	1216LWFG	41.58/30.48/1.57 cm	12 ea
1418LFG	1418LDFG	—	45.72/35.56/1.57 cm	12 ea
1219LFG	1219LDFG	1219LWFG	19.00/30.48/1.57 cm	12 ea
1520LFG	1520LDFG	1520LWFG*	20.25/15.00/1.57 cm	12 ea
1222LFG	1222LDFG	1222LWFG	21.06/12.06/2.03 cm	12 ea
DISPLAY/BAKERY				
269FG	269DFG	269WFG	22.23/64.77/2.84 cm	12 ea
1318FG	1318DFG		45.09/32.39/2.54 cm	12 ea
2618FGQ	2618DFGQ	2618WFGQ	45.39/65.07/3.18 cm	6 ea
Trapezoid				
1713FG	1713DFG	1713WFG	45.72/35.56/2.16 cm	12 ea
2214FG	2214DFG	2214WFG	55.88/35.71/2.24 cm	12 ea
METRIC				
2310FG	2310DFG	2310WFG	589/238/16 mm	12 ea
1220FG	1220DFG	1220WFG	530/325/16 mm	12 ea
1212FG	—	1212WFG	325/265/16 mm	12 ea
2115FG	2115DFG	2115WFG	530/375/16 mm	12 ea
1419FG	1419DFG	1419WFG	500/385/16 mm	12 ea



SPECIALTY TRAYS

Café Trays



- Feature skid-resistant surface and drying/stacking lugs
- Economical & light-weight polypropylene



Prod No	Description	Color	Pack
CT1014	13.87/10.75/0.79 Standard Tray	03, 05, 06, 08, 09, 14, 15, 23, 24, 61, 69	24 ea
CT1216	16.31/12.06/0.70 Standard Tray	03, 05, 06, 08, 09, 14, 15, 23, 24, 31, 59, 61, 69	24 ea
CT1418	45.39/35.56/0.98 Standard Tray	03, 05, 06, 08, 09, 14, 15, 23, 24, 31, 59, 61, 69	12 ea
CT1713TR	45.72/35.56/0.81 Trapezoid Tray	03, 06, 14, 23, 69	12 ea
CT1217	16.93/12.06/0.60 Handled Tray	03, 05, 14, 69	24 ea

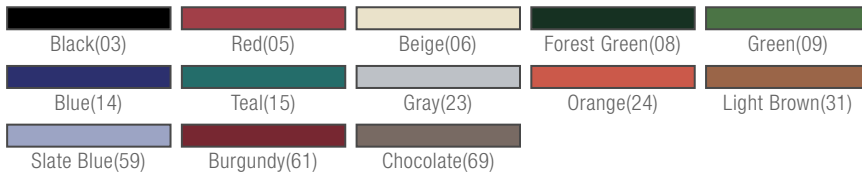

Bistro™ Trays

- Unique trays offer a great look at an economical price
- Durability and economy of our Café Trays with stylish curved handles foreasy handling and added strength
- Scratch-resistant, textured design reduces slipping, helps prevent spills
- Drying and stacking lugs

Prod No	Description	Color	Pack
1217BT	30.48 x 43.18 cm Bistro Tray	Black (03)	12 ea
1319BT	33.02 x 48.26 cm Bistro Tray	Black (03)	12 ea

COMPARTMENT TRAYS

6-Compartment Trays



- The 6-compartment trays hold government Type A* lunch
- Carlisle offers the largest variety of sizes and compartment combinations available
- All materials are FDA approved



Melamine

- Melamine is a heavy, rigid material with the look and feel of china
- It is very scratch- and break-resistant
- Fast drying melamine is highly resistant to chemicals and food acids with a temperature range of -18° to 100°C

Polycarbonate

- Money saving trays carry a five-year warranty against breakage
- Highly break-resistant; perfect choice for correctional facilities
- Polycarbonate offers good scratch- and chemical-resistance with a temperature range of -40° to 100°C

Polypropylene

- Economical, durable choice
- Good chemical resistance
- Temperature range of -1° to 82°C
- Handwashing is recommended

ABS

- Break- & scratch-resistant
- Excellent choice for general use
- Highly resistant to chemicals and food acids with a temperature range of -18° to 82°C

Prod No	Description	Color	Pack
RIGHT-HAND TRAYS			
43988	Heavy-weight Melamine Tray	05, 08, 25, 34, 35, 50, 59, 85, 87	12 ea
43989	Heavy-weight Sandshades/ Rose Granite Melamine	00*, 92	12 ea
614R	ABS Tray	03, 05, 09, 25, 59	24 ea
P614R	Polypropylene Tray	05, 09, 14, 25	24 ea
SPACE-SAVER RIGHT-HAND TRAY			
43982	Space-Saver Melamine Tray	05, 08, 50, 59	12 ea
43983	Space-Saver Sandshades Melamine Tray	92	12 ea
LEFT-HAND TRAYS			
43980	Heavy-weight Melamine Tray	05, 08, 25, 35, 50, 59, 85, 87	12 ea
43981	Heavy-weight Sandshades/Rose Granite Melamine	00*, 92, 93	12 ea
614PC	Polycarbonate Tray	25	24 ea
614	ABS Tray	03	24 ea
P614	Polypropylene Tray	05, 25	24 ea
HANDLED ECONOMY MELAMINE LEFT-HAND TRAY			
5865	Handled Economy Melamine Tray, Variegated	00*	12 ea
SPACE-SAVER OMNI-DIRECTIONAL TRAY			
615**	Space-Saver ABS Tray	03, 05, 14, 25	24 ea

**615 is a licensed product under U.S. Patent D292,768

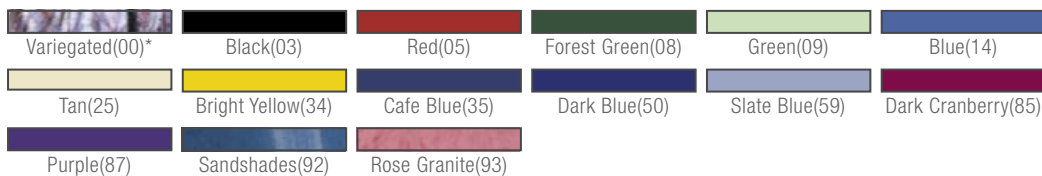

Polycarbonate Compartment Trays



5-COMPARTMENT TRAYS

- 5-year warranty against breakage
- Inside compartments have a textured surface for greater scratch resistance
- 5-year limited warranty

4-COMPARTMENT TRAYS

- Smaller size trays are perfect for elementary schools and lunch menus
- Omni-directional KL444 and 43986 trays feature two-way stacking
- 5-year limited warranty



Prod No	Description	Color	Pack
5-COMPARTMENT TRAYS			
PCD801	5-Compartment Tray, 29.21/26.67/2.54 cm	25	24 ea
4-COMPARTMENT TRAYS			
43984	4-Compartment Tray, Right-Hand, 25.68/24.87/1.30 cm	05, 22, 50	48 ea
43986	4-Compartment Server Tray, 26.16/24.33/2.16 cm	25, 35	36 ea
KL444	4-Compartment Tray, 27.81/22.02/1.57 cm	08, 85	12 ea



Compartment Tray Cover



- Help maintain food temperatures and protect food from contamination and spills



Prod No	Description	Color	Pack
10145	Cover Fits Non-Handled Right and Left Handed 6-Compartment Trays	White (02)	12 ea

Pastry Tray Covers

- Clear covers offer best visibility in bakeries, delis and convenience stores
- Sanitary covers help preserve taste and quality
- Rust-proof stainless steel hinges and screws provide long life



Prod No	Description	Color	Pack
SC25	66.04 x 45.72 x 10.16 cm Cover	Clear (07)	1 ea
SC26	66.04 x 45.72 x 10.16 cm Hinged Cover	Clear (07)	1 ea
SC27	50.80 x 30.48 x 10.16 cm Cover	Clear (07)	3 ea
SC29	50.80 x 30.48 x 10.16 cm Hinged Cover	Clear (07)	3 ea
SC40	45.72 x 33.02 x 10.16 cm Cover	Clear (07)	1 ea

SERVICE TRAYS

Griptite™ 2    **TOP SELLER**

- Griptite 2 trays non-skid surface is designed to grip drinks and plates better than any existing tray
- Heavy-duty fiberglass construction eliminates warping and breakage
- Trays are stain and odor resistant
- 5-year limited warranty



Prod No	Description	Color	Pack
1100GR2	Griptite 2 Round Tray 29.85 cm	004, 076	12 ea
1400GR2	Griptite 2 Round Tray 37.47 cm	004, 076	12 ea
1600GR2	Griptite 2 Round Tray 40.64 cm	004, 076	12 ea
1814GR2	Griptite 2 Rectangular Tray 45.72 x 37.80 cm	004, 076	12 ea
1826GR2Q	Griptite 2 Rectangular Tray 45.72 x 65.41 cm	004, 076	6 ea
2015GR2	Griptite 2 Rectangular Tray 51.44 x 38.10 cm	004, 076	12 ea
2216GR2Q	Griptite 2 Rectangular Tray 55.88 x 40.64 cm	004, 076	6 ea
2500GR2	Griptite 2 Oval Tray 60.96 x 48.90 cm	004, 076	6 ea
2700GR2	Griptite 2 Oval Tray 68.58 x 56.67 cm	004, 076	6 ea
3100GR2	Griptite 2 Oval Tray 80.01 x 59.69 cm	004, 076	6 ea
3253GR2	Griptite 2 Rectangular Tray 82.27 x 53.04 cm	004	12 ea

GripLite® Polypropylene

- Economical alternative
- Made of a high density polypropylene co-polymer
- Molded-in, rubber liner prevents slipping and sliding of glasses and dinnerware
- A more sanitary alternative to cork trays
- Stain and odor resistant



Prod No	Description	Color	Pack
1100GL	28.58/1.93 cm Round Tray	004, 076	12 ea
1400GL	37.16/1.93 cm Round Tray	004, 076	12 ea
1600GL	41.76/1.85 cm Round Tray	004, 076	12 ea



TRAY STANDS



Tray Stands

- Cross supports provide superior rigidity and strength
- Durable and easy to clean
- Available in 3 forms: Steel, Wood & Plastic
- Capped legs on steel tray stands prevent slipping and marring of floors
- Extra tall steel tray stand (C3625T) reduces need for bending and stooping; additional height makes transferring heavy loads easier
- Plastic stands have sanitary, non-porous and non-corrosive finish that is easy to clean with a damp cloth

Prod No	Description	Color	Pack
C3625T	91.44 cm Tall Steel Stand	38	6 ea
C3620W	76.2 cm Wood Stand	11	6 ea
C3630W	77.47 cm Plastic Stand	11	6 ea





CARLISLE
FOODSERVICE PRODUCTS



CATERING EQUIPMENT

CATERAIDE™



IT400



IT410

4 rotating wheels give this dolly unmatched maneuverability



IT140



Flat top design can be used as a prep surface when space is limited



Button-hole latch design offers convenient one hand operation



Exclusive double hinge opens 270°

Cateraide IT End & Top Loader



- Holds six 6.3 cm deep food pans
- Heavy foam insulation holds temperatures in the safe zone for over 6 hours
- Secure stacking for easy transport and storage
- Sure-grip handles promote a safe, stable, two-person lift for easy loading and unloading
- Exclusive, low-profile, double hinge opens 132°C for easy loading and unloading; lies flat to save space and makes it less likely to break
- Field adjustable latches ensure a secure seal for the life of the carrier
- Door hinge can be removed for easy, thorough cleaning
- Built-in seal eliminates gaskets on end & top loaders
- Use with CaterCooler to help keep foods at ServeSafe® temps longer
- *ServeSafe® is a registered trademark of the National Restaurant Association*

Prod No	Description	Color	Case Pack
IT400	End Loader (six pan capacity)	03, 43, 62*	1 ea
IT140	10 cm Top Loader (holds one full size pan up to 10 cm deep)	03, 43	1 ea
IT160	15 cm Top Loader (holds one full size pan up to 15 cm deep)	03, 43	1 ea
IT180	20 cm Top Loader (holds one full size pan up to 20 cm deep)	03, 43	1 ea
IT410	End Loader Dolly with Casters	03	1 ea

*Colors available by special order only





PC660

CaterCooler shown with PC300N End Loader

CaterCooler™

- Freeze CaterCooler overnight or for eight hours and it will keep food at or below the ServSafe® guidelines of 4°C for up to eight hours without ice*
- Designed to slide into a Cateraide End Loader, Double End Loader or place on top of food pans in a Top Loader
- Durable polyethylene shell

ServSafe® is a registered trademark of the National Restaurant Association

*Temperature retention is based on CaterCooler being pre-frozen for a minimum of eight hours, then placed directly into Cateraide pan carrier. Pan Carrier unit is then filled with pre-chilled food pans. Testing was conducted under ambient room temperatures of 24°C.

Prod No	Description	Color	Case Pack
PC660	CaterCooler	14	1 ea

Blue(14)

Pan Carriers



- Cateraide construction made of rugged, stain- and scratch-resistant polyethylene
- Filled with extra thick foam insulation for maximum temperature retention
- Exclusive automatic self-venting system eliminates unsanitary vent openings and easily lost vent caps
- Heat resistant to 93°C
- Individual track for each food pan
- PC300N end loader holds five 6.3 cm deep pans
- PC600N has twice the capacity of the PC300N
- PC600N's separate compartments enable you to put hot food in one; cold in the other
- Use with CaterCooler (shown above) to help keep foods at ServeSafe® temps longer
- Find replacement parts at www.carlislefsp.com/replacement-parts



PC300N

PC600N

Prod No	Description	Color	Case Pack
PC300N	End Loader	01, 03, 08, 59, 95	1 ea
PC600N	Double End Loader	01, 03, 08, 59	1 ea

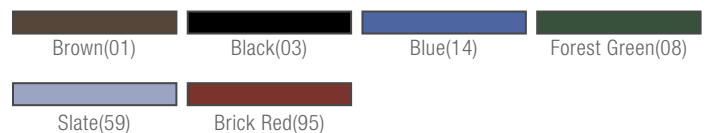

CATERAIDE™ DOLLIES - INDUSTRY LEADER

Polyethylene Dollies



- 10 cm heavy-duty, quiet and non-marking swivel casters
- Rolls easily on carpeted floors
- DL300R holds up to two Cateraide End Loaders (PC300N) or any Cateraide Top Loader
- XDL3000 holds up to two Slide 'N Seal End Loaders (XT3000R) when stacked

Prod No	Description	Color	Case Pack
XDL3000H	51.7 x 73.0 cm Dolly with Handle	03	1 ea
DL300R	51.7 x 67.9 cm Dolly	03	1 ea



PC300 with DL300R

Aluminum Dollies

- Made of sturdy, light-weight, no-rust aluminum
- Plastic coated corner bumpers protect against marring furnishings
- 10 cm heavy-duty, quiet and non-marking swivel casters
- Rolls easily on carpeted floors
- DL300 holds up to two stacked Cateraide End Loaders
- DL1826 holds up to three stacked Sheet Pan Carriers

Prod No	Description	Color	Case Pack
DL300	59.0 x 42.8 cm Dolly	23	1 ea
DL1826	72.7 x 55.8 cm Dolly	23	1 ea



CATERAIDE™ INSULATED ICE CADDIES

- CATERAIDE construction made of rugged, stain- and scratch-resistant polyethylene
- Filled with extra thick foam insulation for maximum temperature retention
- Rounded inside corners and removable lid for thorough cleaning
- Stainless steel, reinforced hinges prevent rusting
- Easy rolling, heavy-duty 12.7 cm casters
- Find replacement parts at www.carlislefsp.com/replacement-parts



IC2220

90 Kg Caddy

- Lid opens and lays flat against side of unit to conserve space
- Front faucet for fast drainage and easy cleanup; inside has sloped base for complete drainage
- Includes convenient shelf; allows water to drain away from ice
- Dual handles for easy maneuverability
- 25.4 cm" non-marking back wheels roll easily over rough surfaces

Prod No	Description	Color	Case Pack
IC2220	90 Kg Ice Caddy with Ice Caddy Shelf; 24.5 cm Wheels, 2 Swivel casters (one with brake)	01, 03, 08*, 59*	1 ea

*Colors available by special order only



IC2250T

IC2254

56 Kg Caddy



- Nylex™ latches eliminate sharp edges; won't rust, bend or dent
- Ice Caddies IC2250 and IC2254 are only 73 cm high for smaller, more compact space requirements
- IC2250T Ice Caddy is 92.7 cm high to reduce back bending motion
- IC2250T Ice Caddy has 20.3 cm non-marking back wheels for easy maneuvering over rough surfaces

Prod No	Description	Color	Case Pack
IC2250	56 Kg Ice Caddy; 2 Rigid Casters, 2 Swivel Casters (one brake)	01*, 03	1 ea
IC2254	56 Kg Ice Caddy; 4 Swivel Casters (one with brake)	01*, 03	1 ea
IC2250T	56 Kg Tall Ice Caddy; 20.3 cm Wheels; 2 Swivel Casters (one with brake)	03	1 ea

*Colors available by special order only





CARLISLE
FOODSERVICE PRODUCTS



KITCHEN ACCESSORIES

HEAT LAMPS

Flexiglow™

- Spun aluminum shade with flared rim for added strength
- Shade is drilled for increased heat dissipation
- Optional NSF Listed maple cutting board and drip pan is perfect for a front-of-the-house carving station
- Rated UL recognized



Prod No	Description	Color	Pack
HL8285	Dual Arm Flexiglow, Aluminum, 60.96 cm Arm	00	1 ea
HL8285G	Dual Arm Flexiglow, Gold, 60.96 cm Arm	21	1 ea
HL8285B**	Dual Arm Flexiglow with Board & Pan, Aluminum, 60.96 cm Arm	00	1 ea
HL8285GB**	Dual Arm Flexiglow with Board & Pan, Gold, 60.96 cm Arm	21	1 ea
HL8185	Flexiglow, Aluminum, 60.96 cm Arm	00	1 ea
HL8185G	Flexiglow, Gold, 60.96 cm Arm	00*	1 ea
HL8185C	Flexiglow, Aluminum, 60.96 cm Arm, Includes Clamp	00	1 ea
HL8185GC	Flexiglow, Gold, 60.96 cm Arm, Includes Clamp	00*	1 ea
HL8185B**	Flexiglow with Board & Pan, Aluminum, 60.96 cm Arm	00	1 ea
HL8185GB**	Flexiglow with Board & Pan, Gold, 60.96 cm Arm	21	1 ea
HLA20	Flexiglow Clamp (8100 & 8200 Series)	00*	1 ea
HL8195	Flexiglow Aluminum, 99.06 cm Arm	00	1 ea
HL8195B**	Flexiglow with Board, Aluminum, 99.06 cm Arm	00	1 ea



MEASURES & SERVING ACCESSORIES

Commercial Measures



- Made of durable polycarbonate
- Offers easy measuring of wet ingredients
- Available in 1/4 liter, 1/2 liter, .95 liter, 1.9 liter and 3.8 liter sizes with U.S. and metric measurements
- Oval shape facilitates pouring from non-spouted side
- Family of measures nest for storage



Prod No	Description	Color	Pack
43141	1/4 Liter Size PC Measure	07, AF07	12 ea
43142	1/2 Liter Size PC Measure	07, AF07	6 ea
43143	0.95 Liter Size PC Measure	07, AF07	6 ea
43144	1.9 Liter Size PC Measure	07, AF07	6 ea
43145	3.8 Liter Size PC Measure	07, AF07	6 ea

Measuring Cup



- Durable polycarbonate with 1/4 liter capacity for measuring liquid ingredients
- Withstands temperatures from -40° to 100°C

Prod No	Description	Color	Pack
4315	Measuring Cup	07	6 ea



MEASURES & SERVING ACCESSORIES

- Portion control

Dishers



- Color-coded for easy identification and portion control
- Smooth operating 18-8 stainless steel construction with ribbed plastic handle
- Bowl capacity is stamped on bail
- Number on bail indicates scoops per 0.95 liter



Prod No	Description	Pack
60300-6	132 ml Disher with White Handle	12 ea
60300-8	113 ml Disher with Gray Handle	12 ea
60300-10	106 ml Disher with Ivory Handle	12 ea
60300-12	92 ml Disher with Green Handle	12 ea
60300-16	78 ml Disher with Blue Handle	12 ea
60300-20	57 ml Disher with Yellow Handle	12 ea
60300-24	50 ml Disher with Red Handle	12 ea
60300-30	37 ml Disher with Black handle	12 ea
60300-40	25 ml Disher with Orchid handle	12 ea

Stainless Steel Measure Misers[®]



- Portion control spoons in heavy gauge 18-8 stainless steel with durable one-piece construction
- Feature color-coded Kool-Touch handles and built-in pan edge rest



Prod No	Description	Pack
604360	57 ml Solid SS Measure Miser, Red	12 ea
604361	57 ml Perforated SS Measure Miser, Red	12 ea
604370	85 ml Solid SS Measure Miser, Beige	12 ea
604371	85 ml Perforated SS Measure Miser, Beige	12 ea
604380	113 ml Solid SS Measure Miser, Green	12 ea
604381	113 ml Perforated SS Measure Miser, Green	12 ea
604390	177 ml Solid SS Measure Miser, Black	12 ea
604392	227 ml Solid SS Measure Miser, Blue	12 ea



Measure Misers

- Portion control spoon made of break-resistant polycarbonate
- Spoon's flat bottom easily spreads sauces or toppings
- Long handle measure misers have thumb grip for steady control and a notch for resting on pan rim
- Recommended for temperatures up to 100°C; withstands dry heat up to 132°C
- 2-year limited warranty



Prod No	Description	Color	Pack
SHORT HANDLE			
4322	43 ml, 18.26 cm Solid Measure Miser w/Red Measurements	06	12 ea
4324	57 ml, 18.11 cm Solid Measure Miser w/Red Measurements	06	12 ea
4362	57 ml, 18.11 cm Perforated Measure Miser w/Red Measurements	06	12 ea
4326	85 ml, 20.32 cm Solid Measure Miser w/Blue Measurements	06	12 ea
4328	113 ml, 20.96 cm Solid Measure Miser w/Green Measurements	06	12 ea
4329	113 ml, 20.96 cm Perforated Measure Miser w/Green Measurements	06	12 ea
4330	177 ml, 21.92 cm Solid Measure Miser w/Black Measurements	06	12 ea
STANDARD HANDLE			
4358	43 ml, 30.33 cm Solid Measure Miser w/Maroon Measurements	06	12 ea
4360	57 ml, 30.33 cm Solid Measure Miser w/Red Measurements	06	12 ea
4361	57 ml, 30.33 cm Perforated Measure Miser w/Red Measurements	06	12 ea
4370	85 ml, 32.39 cm Solid Measure Miser w/Blue Measurements	06	12 ea
4371	85 ml, 32.39 cm Perforated Measure Miser w/Blue Measurements	06	12 ea
4380	113 ml, 33.02 cm Solid Measure Miser w/Green Measurements	06	12 ea
4381	113 ml, 33.02 cm Perforated Measure Miser w/Green Measurements	06	12 ea
4390	177 ml, 33.99 cm Solid Measure Miser w/Black Measurements	06	12 ea
4391	177 ml, 33.99 cm Perforated Measure Miser w/Black Measurements	06	12 ea
BLACK MEASURE MISERS*			
4360-5	57 ml, 30.33 cm Solid Measure Miser	03	12 ea
4370-5	85 ml, 32.39 cm Solid Measure Miser	03	12 ea
4380-5	113 ml, 33.02 cm Solid Measure Miser	03	12 ea
4381-5	113 ml, 33.02 cm Perforated Measure Miser	03	12 ea
4390-5	177 ml, 33.99 cm Solid Measure Miser	03	12 ea

*Black Measure Misers do not have color-coding





Color-Coded Measure Misers



- Portion control spoon made of break-resistant acetal material
- Each color represents a different size for easy recognition and consistency
- Spoon's flat bottom easily spreads sauces or toppings
- Long handle measure misers have thumb grip for steady control and a notch for resting on pan rim
- Recommended for temperatures up to 100°C; Withstands dry heat up to 132°C
- 2-year limited warranty

Prod No	Description	Color	Pack	Prod No	Description	Color	Pack
SHORT HANDLE				LONG HANDLE			
4921	30 ml, 16.51 cm Solid Spoon	04, 89	12 ea	3956	30 ml, 29.21 cm Solid Spoon	04, 89	12 ea
4923	30 ml, 16.51 cm Perforated Spoon	04	12 ea	3957	30 ml, 28.58 cm Perforated Spoon	04	12 ea
4932	37 ml, 18.42 cm Solid Spoon	75	12 ea	3958	44 ml, 29.21 cm Solid Spoon	01	12 ea
4965	37 ml, 18.42 cm Perforated Spoon	75	12 ea	3959	44 ml, 29.21 cm Perforated Spoon	01	12 ea
4922	44 ml, 17.78 cm Solid Spoon	01	12 ea	3960	57 ml, 30.23 cm Solid Spoon	05, 89	12 ea
4961	44 ml, 17.78 cm Perforated Spoon	01	12 ea	3961	57 ml, 30.23 cm Perforated Spoon	05	12 ea
4924	57 ml, 18.03 cm Solid Spoon	05, 89	12 ea	3970	85 ml, 29.85 cm Solid Spoon	02	12 ea
4962	57 ml, 18.03 cm Perforated Spoon	05, 89	12 ea	3971	85 ml, 29.85 cm Perforated Spoon	02	12 ea
4925	71 ml, 18.03 cm oz Solid Spoon	24	12 ea	3980	113 ml, 33.02 cm Solid Spoon	08, 89	12 ea
4963	71 ml, 18.03 cm Perforated Spoon	24	12 ea	3981	113 ml, 33.02 cm Perforated Spoon	08, 89	12 ea
4926	85 ml, 20.32 cm Solid Spoon	02, 89	12 ea	3990	177 ml, 34.04 cm Solid Spoon	03	12 ea
4927	85 ml, 20.32 cm Perforated Spoon	02	12 ea	3991	177 ml, 34.04 cm Perforated Spoon	03	12 ea
4928	113 ml, 20.96 cm Solid Spoon	08, 89	12 ea	3992	227 ml, 33.66 cm Solid Spoon	14	12 ea
4929	113 ml, 20.96 cm Perforated Spoon	08	12 ea	3993	227 ml, 33.66 cm Perforated Spoon	14	12 ea
4933	142 ml, 21.89 cm Solid Spoon	06	12 ea				
4966	142 ml, 21.89 cm Perforated Spoon	06	12 ea				
4930	177 ml, 21.89 cm Solid Spoon	03, 89	12 ea				
4967	177 ml, 21.89 cm Perforated Spoon	03	12 ea				
4964	177 ml, 21.89 cm Deep Cup Perforated Spoon	03	12 ea				
4931	227 ml, 21.89 cm Solid Spoon	14	12 ea				
4968	227 ml, 21.89 cm Perforated Spoon	14	12 ea				

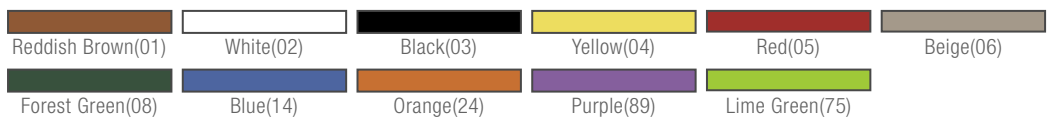

DREDGES

Metal Dredge

- Heavy-duty seamless dredges in aluminum
- 18-8 mirror polish stainless with wide screw tops for easy filling

Prod No	Description	Pack
6031	Alumilite Dredge with Handle	12 ea



6031



Shaker/Dredge

- Durable break-resistant polycarbonate shaker can be customized with your logo
- Call Customer Service at 1-800-654-8210 for custom imprinting information; also ask about our BPA-free versions available by special order
- Additional lids can be purchased separately to accommodate different toppings
- Different hole sizes available for portioning materials that vary in size



4251

Prod No	Description	Color	Pack
4250	Dredge with Medium Ground, Rose Lid	55	12 ea
4260	Dredge with Cheese, Yellow Lid	04	12 ea
4270	Dredge with Salt & Pepper, Beige Lid	06	12 ea
4230	Dredge with Translucent Parsley Lid	30	12 ea
4231	Translucent Parsley Lid	30	12 ea
4251	Rose Medium Ground Lid	55	12 ea
4261	Yellow Cheese Lid	04	12 ea
4271	Beige Salt & Pepper Lid	06	12 ea



SPATULAS & SCRAPERS

Sparta® Color-Coded Spatulas & Paddle Scrapers

- Spatulas are perfect for general mixing and stirring
- Standard Nylon (149°C) or soft flexible Polyethylene (66°C) blades will sharpen and contour to your specific application with usage
- Smooth finished, water-proof construction for easy clean-up
- Replacement blades are available for this product



40352C

Prod No	Description	Color	Pack
40350C	Sparta Scraper with Plastic Handle, 34.29 cm L	04, 05, 09, 14	6 ea
40352C	Sparta Paddle Scraper with Plastic Handle, 101.6 cm L	04, 05, 09, 14	6 ea
40353C	Sparta Paddle Scraper with Plastic Handle, 121.92 cm L	04, 05, 09, 14	6 ea
40361C	Sparta Standard Nylon Replacement Blade, 19.05 cm x 11.43 cm L	04, 05, 09, 14	6 ea



High Heat Serving Spoons & Turner

- High heat material withstands temperatures from -40°C to 191°C without melting or transferring heat
- Helps prevent scratching on coated surfaces
- Notched handle with hole for hanging



Prod No	Description	Color	Pack
4415	27.94 cm Solid High Heat Serving Spoon	03	12 ea
4416	27.94 cm Perforated High Heat Serving Spoon	03	12 ea
4425	33.02 cm Solid High Heat Serving Spoon	03	12 ea
4426	33.02 cm Perforated High Heat Serving Spoon	03	12 ea
4900	33.02 cm Slotted Turner	03, 13	12 ea



SCOOPS

Metal Scoops



- Heavy-duty scoops have easy to hold pistol-grip handles with clearly marked capacities

Prod No	Description	Color	Pack
606040	1077 ml Solid Cast Aluminum Scoop	—	12 ea
606055	1644 ml Solid Cast Aluminum Scoop	—	12 ea
606086	2409 ml Solid Cast Aluminum Scoop	—	12 ea
4306	177 ml Polycarbonate Scoop	07 (Clear)	12 ea
4332	907 ml Polycarbonate Scoop	07 (Clear)	12 ea
4364	1814 ml Polycarbonate Scoop	07 (Clear)	6 ea



Polycarbonate Scoops

- Easy-grip plastic handle doesn't transfer cold
- Features a hole for hanging or tying to a container
- Durable polycarbonate material

Prod No	Description	Color	Pack
606040	1077 ml Solid Cast Aluminum Scoop	—	12 ea
606055	1644 ml Solid Cast Aluminum Scoop	—	12 ea
606086	2409 ml Solid Cast Aluminum Scoop	—	12 ea
4306	177 ml Polycarbonate Scoop	07 (Clear)	12 ea
4332	907 ml Polycarbonate Scoop	07 (Clear)	12 ea
4364	1814 ml Polycarbonate Scoop	07 (Clear)	6 ea





STORAGE & HANDLING

STORPLUS™ FOOD PANS AND LIDS



Polycarbonate Food Pans & Lids



- Reinforced corners prevent chips and cracks, stand up to drops and use day after day
- Universally stackable with all food pan products on the market
- Spoonable bottoms allow easy removal of contents and reduction of food waste
- Polycarbonate containers can withstand temperatures from -40°C to 100°C



Prod No	Description	Color	Pack
FULL-SIZE – 52.71 CM X 32.39 CM			
10200B	Pan – 6.35 cm (7.19 L)	03, 07	6 ea
10201B	Pan – 10.16 cm (12.02 L)	03, 07	6 ea
10202B	Pan – 15.24 cm (18.36 L)	03, 07	6 ea
10203B	Pan – 20.32 cm (24.51 L)	03, 07	6 ea
10215	Drain Shelf	07	6 ea
LIDS – FITS ALL FULL-SIZE PANS			
10212B	Smart Lid, Unnotched	60	6 ea
10210U	Handled Lid, Unnotched	07	6 ea
10211U	Handled Lid, Single Notched	07	6 ea
10216U	Flat Lid, Unnotched	07	6 ea
10217U	Flat Lid, Single Notched	07	6 ea
ONE-HALF SIZE – 32.39 CM X 26.37 CM			
10220B	Pan – 6.35 cm (3.41 L)	03, 07	6 ea
10221B	Pan – 10.16 cm (5.3 L)	03, 07	6 ea
10222B*	Pan – 15.24 cm (8.23 L)	03, 07	6 ea
10223B	Pan – 20.32 cm (10.79 L)	07	6 ea
10235	Drain Shelf	07	6 ea
LIDS – FITS ALL ONE-HALF SIZE PANS			
10232B	Smart Lid, Unnotched	60	6 ea
10230U	Handled Lid, Unnotched	07	6 ea
10231U	Handled Lid, Single Notched	07	6 ea
10236U	Flat Lid, Unnotched	07	6 ea
ONE-HALF LONG SIZE – 52.71 CM X 15.88 CM			
10240B	Pan – 6.35 cm (2.74 L)	03, 07	6 ea
10241B	Pan – 10.16 cm (4.83 L)	03, 07	6 ea
LIDS – FITS ALL ONE-HALF LONG SIZE PANS			
10250U	Handled Lid, Unnotched	07	6 ea
10256U	Flat Lid, Unnotched	07	6 ea
ONE-THIRD SIZE – 32.39 CM X 17.78 CM			
30660	Pan – 6.35 cm (2.27 L)	03, 07	6 ea
30661	Pan – 10.16 cm (3.6 L)	03, 07	6 ea
30662	Pan – 15.24 cm (5.39 L)	03, 07	6 ea
30669	Pan – 20.32 cm (6.91 L)	03, 07	6 ea
30670	Drain Shelf	07	6 ea
LIDS – FITS ALL ONE-THIRD SIZE PANS			
30580	Smart Lid, Unnotched	60	6 ea
10270U	Handled Lid, Unnotched	07	6 ea
10271U	Handled Lid, Single Notched	07	6 ea
10276U	Flat Lid, Unnotched	07	6 ea

Prod No	Description	Color	Pack
10277U	Flat Lid, Single Notched	07	6 ea
ONE-QUARTER SIZE – 26.04 CM X 16.21 CM			
30680	Pan – 6.35 cm (1.61 L)	03, 07	6 ea
30681	Pan – 10.16 cm (2.65 L)	03, 07	6 ea
30682	Pan – 15.24 cm (3.79 L)	03, 07	6 ea
30695	Drain Shelf	07	6 ea
LIDS – FITS ALL ONE-QUARTER SIZE PANS			
30581	Smart Lid, Unnotched	60	6 ea
10290U	Handled Lid, Unnotched	07	6 ea
10291U	Handled Lid, Single Notched	07	6 ea
10296U	Flat Lid, Unnotched	07	6 ea
10297U	Flat Lid, Single Notched	07	6 ea
ONE-SIXTH SIZE – 17.15 CM X 16.21 CM			
30683	Pan – 6.35 cm (1.04 L)	03, 07	6 ea
30684	Pan – 10.16 cm (1.61 L)	03, 07	6 ea
30685	Pan – 15.24 cm (2.37 L)	03, 07	6 ea
30689	Drain Shelf	07	6 ea
LIDS – FITS ALL ONE-SIXTH SIZE PANS			
30582	Smart Lid, Unnotched	60	6 ea
10310U	Handled Lid, Unnotched	07	6 ea
10311U	Handled Notched Lid	07	6 ea
10316U	Flat Lid, Unnotched	07	6 ea
10317U	Flat Lid, Single Notched	07	6 ea
ONE-NINTH SIZE – 17.15 CM X 10.8 CM			
30686	Pan – 6.35 cm (0.66 L)	03, 07	6 ea
30687	Pan – 10.16 cm (0.95 L)	03, 07	6 ea
30688	Pan – 15.24 cm (1.32 L)	03, 07	6 ea
10335	Drain Shelf	07	6 ea
LIDS – FITS ALL ONE-NINTH SIZE PANS			
30583	Smart Lid, Unnotched	60	6 ea
10336U	Flat Lid, Unnotched	07	6 ea
10337U	Flat Lid, Single Notched	07	6 ea



Smart Lid's unique inside seal design provides superior leak-resistance; protects against spills



EZ Access Lids



- 50% to 60% larger opening improves hand and utensil access; reduces foodwaste
- Snug lid stays in place during routine opening; never flips off
- Clean design eliminates dangerous food traps found on other hinged lid designs
- Compliment your Coldmaster and CoolCheck pans

Prod No	Description	Color	Pack
EZ ACCESS LIDS – ONE HALF SIZE			
10238Z	Handled Lid, Unnotched	07	6 ea
10239Z	Handled Lid, Single Notched	07	6 ea
10240Z	Handled Lid, Double Notched	07	6 ea
EZ ACCESS LIDS – ONE THIRD SIZE			
10278Z	Handled Lid, Unnotched	07	6 ea
10279Z	Handled Lid, Single Notched	07	6 ea
10280Z	Handled Lid, Double Notched	07	6 ea
EZ ACCESS LIDS – ONE SIXTH SIZE			
10318Z	Handled Lid, Unnotched	07	6 ea
10319Z	Handled Lid, Single Notched	07	6 ea
EZ ACCESS LIDS – ONE NINTH SIZE			
10338Z	Handled Lid, Unnotched	07	6 ea
10339Z	Handled Lid, Single Notched	07	6 ea



High Heat Food Pans & Lids

- High heat pans excel in high temperature applications (-40°C to 191°C)
- For a leak-resistant seal use Smart Lids

Prod No	Description	Color	Pack
FULL-SIZE – 52.71 CM X 32.39 CM			
10400B	Pan – 6.35 cm (7.19 L)	03, 13	6 ea
10401B	Pan – 10.16 cm (12.02 L)	03, 13	6 ea
10402B	Pan – 15.24 cm (18.36 L)	03, 13	6 ea
10415	Drain Shelf	13	6 ea
LIDS – FITS ALL FULL-SIZE PANS			
10212B	Smart Lid, Unnotched	60	6 ea
10410U	Handled Lid, Unnotched	13	6 ea
10411U	Handled Lid, Single Notched	13	6 ea
10416U	Flat Lid, Unnotched	13	6 ea
10417U	Flat Notched Lid	13	6 ea
ONE-HALF SIZE – 32.39 CM X 26.37 CM			
10420B	Pan – 6.35 cm (3.41 L)	03, 13	6 ea
10421B	Pan – 10.16 cm (5.3 L)	03, 13	6 ea
10422B	Pan – 15.24 cm (8.23 L)	03, 13	6 ea
10423B	Pan – 20.32 cm (10.79 L)	03, 13	6 ea
10435	Drain Shelf	13	6 ea
LIDS – FITS ALL ONE-HALF SIZE PANS			
10232B	Smart Lid, Unnotched	60	6 ea
10430U	Handled Lid, Unnotched	13	6 ea
10431U	Handled Lid, Single Notched	13	6 ea
10436U	Flat Lid, Unnotched	13	6 ea
10437U	Flat Lid, Single Notched	13	6 ea
ONE-HALF LONG SIZE – 52.71 CM X 15.88 CM			
10440B	Pan – 6.35 cm (2.74 L)	03, 13	6 ea
10441B	Pan – 10.16 cm (4.83 L)	03, 13*	6 ea
LIDS – FITS ALL ONE-HALF LONG SIZE PANS			
10450U	Handled Lid, Unnotched	13	6 ea
ONE-THIRD SIZE – 32.39 CM X 17.78 CM			
30860	Pan – 6.35 cm (2.27 L)	03, 13	6 ea
30861	Pan – 10.16 cm (3.6 L)	03, 13	6 ea
30862	Pan – 15.24 cm (5.39 L)	03, 13	6 ea
30869	Pan – 20.32 cm (6.91 L)	03, 13	6 ea
30870	Drain Shelf	13	6 ea

Prod No	Description	Color	Pack
LIDS – FITS ALL ONE-THIRD SIZE PANS			
30580	Smart Lid, Unnotched	60	6 ea
10470U	Handled Lid, Unnotched	13	6 ea
10471U	Handled Lid, Single Notched	13	6 ea
10476U	Flat Lid, Unnotched	13	6 ea
10477U	Flat Lid, Single Notched	13	6 ea
ONE-QUARTER SIZE – 26.04 CM X 16.21 CM			
30880	Pan – 6.35 cm (1.61 L)	03, 13	6 ea
30881	Pan – 10.16 cm (2.65 L)	03, 13	6 ea
30882	Pan – 15.24 cm (3.79 L)	03, 13	6 ea
30895	Drain Shelf	13	6 ea
LIDS – FITS ALL ONE-QUARTER SIZE PANS			
30581	Smart Lid, Unnotched	60	6 ea
10490U	Handled Lid, Unnotched	13	6 ea
10491U	Handled Lid, Single Notched	13	6 ea
10496U	Flat Lid, Unnotched	13	6 ea
ONE-SIXTH SIZE – 17.15 CM X 16.21 CM			
30883	Pan – 6.35 cm (1.04 L)	03, 13	6 ea
30884	Pan – 10.16 cm (1.61 L)	03, 13	6 ea
30885	Pan – 15.24 cm (2.37 L)	03, 13	6 ea
30896	Drain Shelf	13	6 ea
LIDS – FITS ALL ONE-SIXTH SIZE PANS			
30582	Smart Lid, Unnotched	60	6 ea
10510U	Handled Lid, Unnotched	13	6 ea
10511U	Handled Lid, Single Notched	13	6 ea
10516U	Flat Lid, Unnotched	13	6 ea
ONE-NINTH SIZE – 17.15 CM X 10.8 CM			
30886	Pan – 6.35 cm (0.66 L)	03, 13	6 ea
30887	Pan – 10.16 cm (0.95 L)	03, 13	6 ea
30888	Pan – 15.24 cm (1.32 L)	03, 13	6 ea
10535	Drain Shelf	13	6 ea
LIDS – FITS ALL ONE-NINTH SIZE PANS			
30583	Smart Lid, Unnotched	60	6 ea
10536U	Flat Lid, Unnotched	13	6 ea
10537U	Flat Lid, Single Notched	13	6 ea





EZ Access Lids for High Heat Food Pans



Prod No	Description	Color	Pack
ONE HALF SIZE			
10438Z	EZ Access Lid, Unnotched	13	6 ea
10439Z	EZ Access Lid, Single Notched	13	6 ea
10440Z	EZ Access Lid, Double Notched	13	6 ea
ONE THIRD SIZE			
10478Z	EZ Access Lid, Unnotched	13	6 ea
10479Z	EZ Access Lid, Single Notched	13	6 ea
10480Z	EZ Access Lid, Double Notched	13	6 ea
ONE HALF SIZE			
10518Z	EZ Access Lid, Unnotched	13	6 ea
10519Z	EZ Access Lid Notched	13	6 ea
ONE NINTH SIZE			
10538Z	EZ Access Lid, Unnotched	13	6 ea
10539Z	EZ Access Lid, Single Notched	13	6 ea

Specialty High Heat Handled Pans



- Transports food safely from the oven to the warming unit
- Double handled pan is perfect for restaurants with "pass through" warming units
- Stain-, heat- and impact- resistant high heat material
- Available in 6.35 cm and 10.16 cm depths

Prod No	Description	Color	Pack
30860H	1/3 Size 6.35 cm Deep with 1 Handle	13	6 ea
30860HH	1/3 Size 6.35 cm Deep with 2 Handles	13	6 ea
30861H	1/3 Size 10.16 cm Deep with 1 Handle	13	6 ea
30861HH	1/3 Size 10.16 cm Deep with 2 Handles	13	6 ea
30871	1/6 Size 6.35 cm Deep Pan Divider	13	8 ea



Amber(13)

STORPLUS™ STORAGE BOXES



Food Storage Boxes



- Reinforced top and bottom corners on both box and lid, help prevent chipping and cracking
- StorPlus boxes stack easily for efficient storage, fit standard carts and racks and with other boxes on the market
- "Lock-Tight" lids can be reversed and used as bun pan or tray
- Polycarbonate boxes provide easy visibility, superior resistance to food acids and oils and withstands temperatures from -40°C to 100°C
- Polyethylene boxes offers economical storage and transport and with stands temperatures from -40°C to 82°C

Color-Coded Storage Boxes

- Prevent cross-contamination and help meet standards as part of a complete HACCP Program
- RimGlow™ technology gives the boxes and lids a distinct, yet transparent color to segregate them by usage

Prod No	Color	Prod No	Color	Description	Pack
CLEAR POLYCARBONATE*		COLOR-CODED POLYCARBONATE			
10610	07			7.6 Liter 30 x 45 x 8.8 cm Box	6 ea
10611	07	10611C	05, 09, 14, 22	13 Liter 30 x 45 x 15.24 cm Box	6 ea
10612	07	10612C	05, 09, 14, 22	18.9 Liter 30 x 45 x 22.8 cm Box	6 ea
10617	07	10617C	05, 09, 14, 22	30 x 45 cm Lid	6 ea
10620	07	—		18.9 Liter 45 x 66 x 8.8 cm Box	6 ea
10621	07	10621C	05, 09, 14, 22, 89	32 Liter 45 x 66 x 15.24 cm Box	6 ea
10622	07	10622C	05, 09, 14, 22, 89	47 Liter 45 x 66 x 22.9 cm Box	4 ea
10623	07	10623C	05, 09, 14, 22	62.8 Liter 45 x 66 x 30 cm Box	3 ea
10624	07	10624C	05, 09, 14, 22	81.4 Liter 45 x 66 x 38.1 cm Box	3 ea
10627	07	10627C	05, 09, 14, 22, 89	45 x 66 cm Lid	6 ea
10628	07	—		45 x 66 x 12.7 cm Colander	6 ea
10629	07	—		45 x 66 cm Drain Grate	6 ea



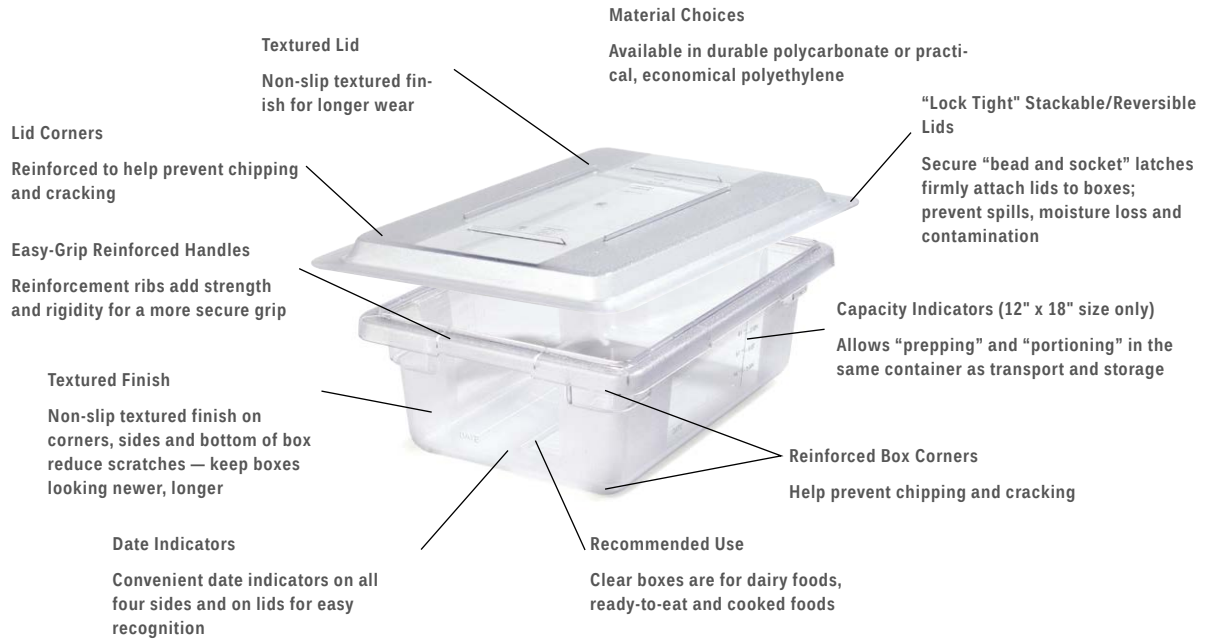

Lids are reversible, stackable and make great serving trays for catering



Square Food Storage Containers



- Stacking lugs add rigidity and eliminate jamming
- Wide handles and drain holes available on all sizes for easy-grip and quick drying
- Color-coded, textured snap-on lids fit both polycarbonate and polyethylene containers
- Spoonable bottom prevents food waste and makes clean-up easy
- Clear polycarbonate containers provide exceptional durability and can withstand temperatures from -40°F to 100°C
- Economical white polyethylene containers withstand temperatures from -40°C to 82°C



Prod No	Description	Color	Pack
STORPLUS SQUARE POLYCARBONATE FOOD STORAGE CONTAINERS			
10720	1.9 Liter, 18.11 cm Sq x 9.7 cm H Polycarbonate Container	07, AF07	6 ea
10721	3.8 Liter, 18.11 cm Sq x 18.6 cm H Polycarbonate Container	07, AF07	6 ea
10722	5.7 Liter, 22 cm Sq x 18.6 cm H Polycarbonate Container	07, AF07	6 ea
10723	7.8 Liter, 22 cm Sq x 22.9 cm H Polycarbonate Container	07, AF07	6 ea
10724	11.4 Liter, 28.3 cm Sq x 20.96 cm H Polycarbonate Container	07, AF07	6 ea
10725	17 Liter, 28.3 cm Sq x 32 cm H Polycarbonate Container	07, AF07	6 ea
10726	21 Liter, 28.3 cm Sq x 40 cm H Polycarbonate Container	07, AF07	6 ea
STORPLUS SQUARE POLYETHYLENE FOOD STORAGE CONTAINERS			
10730	1.9 Liter, 18.11 cm Sq x 9.7 cm H Polyethylene Container	02	6 ea
10731	3.8 Liter, 18.11 cm Sq x 18.6 cm H Polyethylene Container	02	6 ea
10732	5.7 Liter, 22 cm Sq x 18.6 cm H Polyethylene Container	02	6 ea
10733	7.8 Liter, 22 cm Sq x 22.9 cm H Polyethylene Container	02	6 ea
10734	11.4 Liter, 28.3 cm Sq x 20.96 cm H Polyethylene Container	02	6 ea
10735	17 Liter, 28.3 cm Sq x 32 cm H Polyethylene Container	02	6 ea
10736	21 Liter, 28.3 cm Sq x 40 cm H Polyethylene Container	02	6 ea
STORPLUS SQUARE CONTAINER LIDS			
10740	1.9-3.8 Liter, 18.6 cm Sq Lid	08, 89	6 ea
10741	5.7-7.8 Liter, 22.9 cm Sq Lid	05, 89	6 ea
10742	11.4-17-21 Liter, 29 cm Sq Lid	60, 89	6 ea
STORPLUS 3-PACK SQUARE CONTAINERS (INCLUDES LIDS)			
10720-307	1.9 Liter, 18.11 cm Sq x 9.7 cm H Polycarbonate Container	07 / 08	3 ea
10721-307	3.8 Liter, 18.11 cm Sq x 18.6 cm H Polycarbonate Container	07 / 08	3 ea
10730-302	1.9 Liter, 18.11 cm Sq x 9.7 cm H Polyethylene Container	02 / 08	3 ea
10731-302	3.8 Liter, 18.11 cm Sq x 18.6 cm H Polyethylene Container	02 / 08	3 ea
STORPLUS 2-PACK SQUARE CONTAINERS (INCLUDES LIDS)			
10722-207	5.7 Liter, 22 cm Sq x 18.6 cm H Polycarbonate Container	07 / 05	2 ea
10723-207	7.8 Liter, 22 cm Sq x 22.9 cm H Polycarbonate Container	07 / 05	2 ea
10732-202	5.7 Liter, 22 cm Sq x 18.6 cm H Polyethylene Container	02 / 05	2 ea
10733-202	7.8 Liter, 22 cm Sq x 22.9 cm H Polyethylene Container	02 / 05	2 ea





Round Food Storage Containers



- Super-tough, clear polycarbonate for ultimate durability allows easy food content identification at a glance
- StorPlus containers stack with other major brands for convenient storage; stacking shoulder prevents jamming
- Date indicator helps maintain food quality and control inventory turns, interchangeable with other brands
- Exclusive Carlisle spoonable bottom for increased yield and less food waste
- Clear polycarbonate containers can withstand temperatures from -40°F to 100°C

Prod No	Description	Color	Pack
STORPLUS ROUND FOOD STORAGE CONTAINERS			
10761	.95 Liter Round Container	07	12 ea
10763	1.9 Liter Round Container	07	12 ea
10764	3.8 Liter Round Container	07	12 ea
10765	5.7 Liter Round Container	07	12 ea
10766	7.8 Liter Round Container	07	12 ea
10767	11.4 Liter Round Container	07	6 ea
10768	17 Liter Round Container	07	6 ea
10769	21 Liter Round Container	07	6 ea
STORPLUS ROUND CONTAINER LIDS			
10770	.95 Liter Round Lid	30	12 ea
10771	1.9-3.8 Liter Round Lid	08	12 ea
10772	5.7-7.8 Liter Round Lid	05	12 ea
10773	11.4-17-21 Liter Round Lid	60	6 ea





CARLISLE
FOODSERVICE PRODUCTS

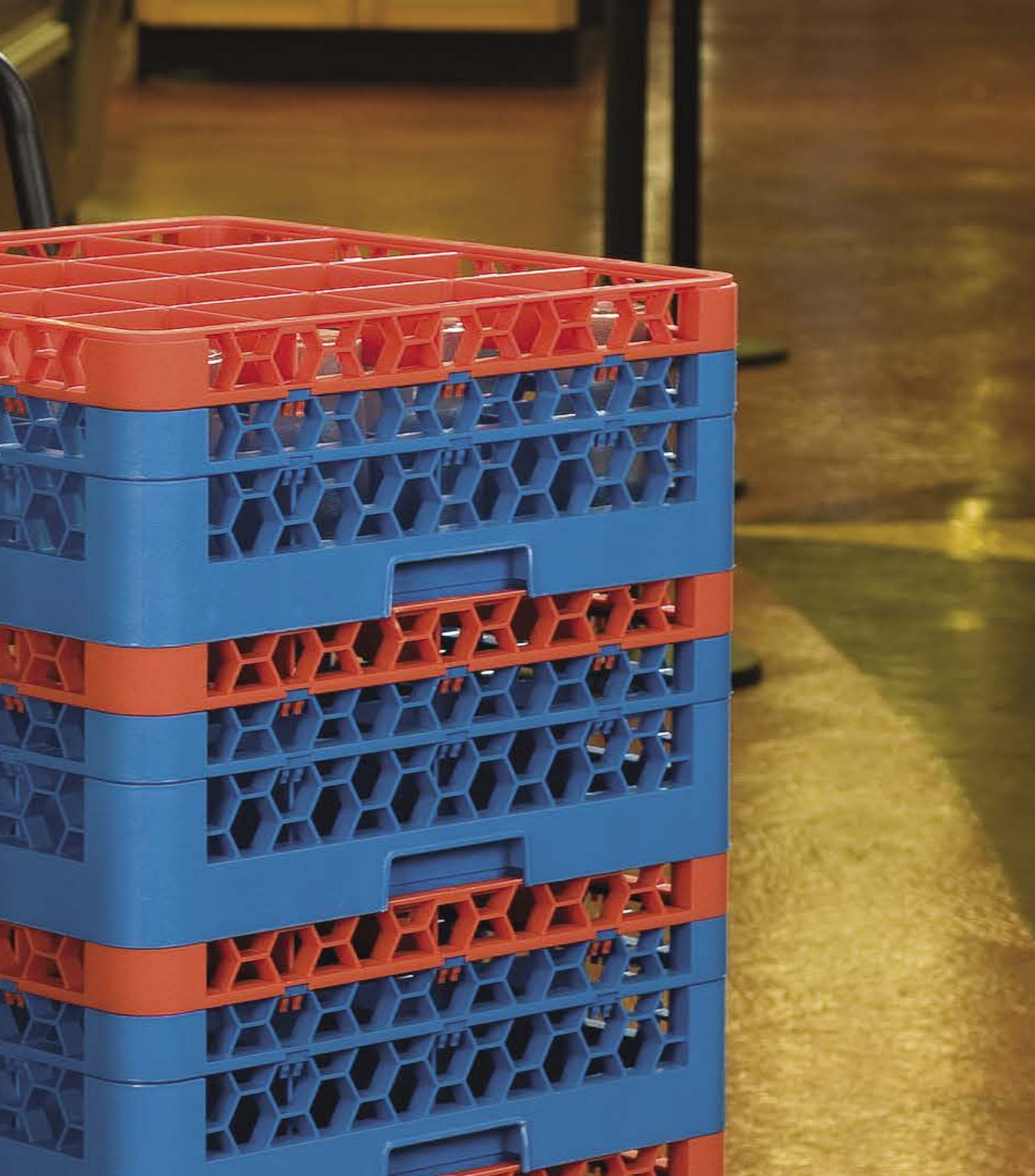

WAREWASHING

HOW TO CREATE THE CORRECT ITEM NUMBER FOR YOUR WASHRACK

- 1** Each item begins with an R for rack
 - 2** Second digit indicates type
 - G - Glass
 - W - NeWave
 - C - Cup
 - P - Peg/Plate*
 - B - Bowl*
 - F - Flatware*
 - SP - Sheet Pan*
 - FP - Food Pan*
 - PC - Plate Cover*
 - TP - Tall Peg*
 - OP - Open Peg*
- *Skip to Step Six
Only available in Blue(14)

- 3** Glass, NeWave (only 20 or 30) & Cup (only 16 or 20) racks have additional digits beginning with number of compartments
 - 9 - Nine Compartment
 - 16 - Sixteen Compartment
 - 20 - Twenty Compartment
 - 25 - Twenty-five Compartment
 - 30 - Thirty Compartment
 - 36 - Thirty-six Compartment
 - 49 - Forty-nine Compartment

- 4** To add extenders, add a dash and the # of extenders*
 - 1 - One Extender
 - 2 - Two Extenders
 - 3 - Three Extenders
 - 4 - Four Extenders
 - 5 - Five Extenders
- * RW racks have a standard integrated extender, therefore an additional extender for each line listed above e.g. RW20-1 includes two extenders.

- 5** If you want color-coded extenders, add a C — Otherwise, skip this step

- 6** Lastly, add the color-code
 - 410 - Red/Blue
 - 411 - Yellow/Blue
 - 412 - Orange/Blue
 - 413 - Green/Blue
 - 414 - Lavender/Blue
 - 14 - Blue

- 7** This order is for a glass rack with 25 compartments, 3 extenders and the top extender is red.

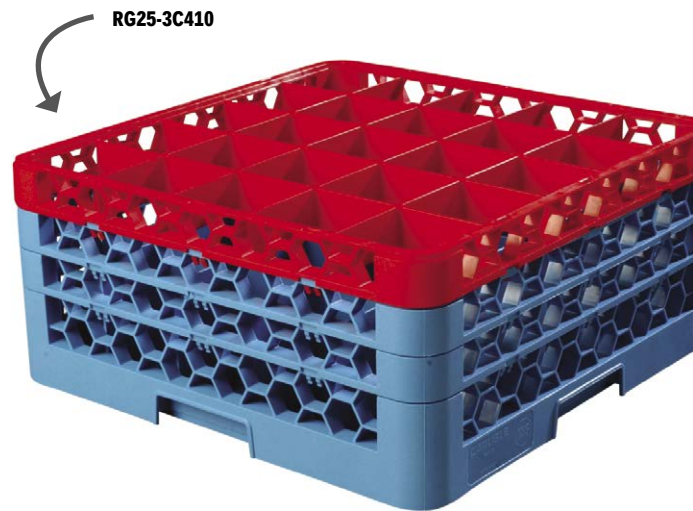

EXTENDER HEIGHTS

No Extender	79 mm
1 Extender	117 mm
2 Extenders	155 mm
3 Extenders	193 mm
4 Extenders	231 mm
5 Extenders	269 mm

- Extenders are available in multiple colors including Blue(14), Yellow(04), Red(05), Green(09), Orange(24), Lavender(89)
- Additional accessories can be found at the web address below

WASHRACK SIZING

Rack No	Description	Min Dia	Max Dia	Dia for Handles
STANDARD				
RG49	49 Compartment Glass Rack	51 mm	60 mm	73 mm
RG36	36 Compartment Glass Rack	60 mm	70 mm	92 mm
RG25	25 Compartment Glass Rack	70 mm	86 mm	111 mm
RG16	16 Compartment Glass Rack	86 mm	111 mm	142 mm
RG9	9 Compartment Glass Rack	111 mm	149 mm	196 mm
NUWAVE				
RW30	Glass Rack w/ Integrated Extender 30 Compartment	67 mm	76 mm	
RW20	Glass Rack w/ Integrated Extender 20 Compartment	76 mm	95 mm	
TILTED CUP				
RC20	Tilted Cup Rack 20 Compartment	67 mm	108 mm	130 mm
RC16	Tilted Cup Rack 16 Compartment	108 mm	111 mm	168 mm

Find The Perfect Glass Rack www.carlislefsp.com/FINDRACK

OPTICLEAN GLASS RACKS

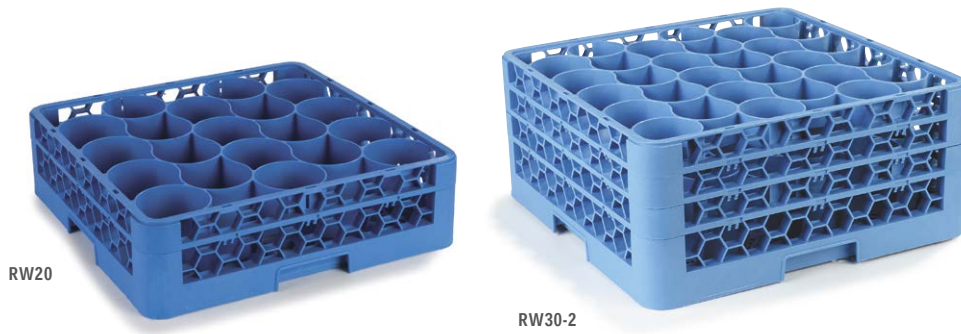

OptiClean NeWave Color-Coded Glass Racks



- Fits 25% more glasses which saves on chemical cost by washing more glasses per cycle
- Honeycomb design allows a free flow of soap and water and balanced weight dispersion when racks are stacked high
- Compatible stacking with standard dish racks ensuring a smooth transition to Carlisle washracks without interrupting workflow
- Color coded extenders allow for convenient identification
- Most durable rack in the market
- NeWave 20-compartment and 30-compartment racks for glasses & tumblers
- REW20S, REW20SC, RW30, REW30S and REW30SC: not NSF listed

Prod No	Description	Glass Dia	Glass Height	Color	Pack
20-COMPARTMENT OPTICLEAN NEWAVE GLASS RACK - COMPARTMENT SIZE 96 MM DIA					
RW20	20-Compartment with Integrated Extender	90.4 mm	120 mm	14	4 ea
RW20-1	20-Compartment with 2 Extenders	90.4 mm	161 mm	14	3 ea
RW20-2	20-Compartment with 3 Extenders	90.4 mm	201 mm	14	2 ea
RW20-3	20-Compartment with 4 Extenders	90.4 mm	241 mm	14	2 ea
REW20S	20-Compartment Extender	90.4 mm	38 mm	14	6 ea
20-COMPARTMENT COLOR-CODED OPTICLEAN NEWAVE GLASS RACK - COMPARTMENT SIZE 96 MM DIA					
REW20SC	20-Compartment Divided Extender	90.4 mm	38 mm	04, 05, 09, 24, 89	6 ea
RW20-C	20-Compartment with Integrated Extender	90.4 mm	120 mm	410, 411, 412, 413, 414	4 ea
RW20-1C	20-Compartment with 2 Extenders	90.4 mm	161 mm	410, 411, 412, 413, 414	3 ea
RW20-2C	20-Compartment with 3 Extenders	90.4 mm	201 mm	410, 411, 412, 413, 414	2 ea
RW20-3C	20-Compartment with 4 Extenders	90.4 mm	241 mm	410, 411, 412, 413, 414	2 ea
RW20-4C	20-Compartment with 5 Extenders	90.4 mm	281 mm	410, 411, 412, 413, 414	1 ea
30-COMPARTMENT OPTICLEAN NEWAVE GLASS RACK - COMPARTMENT SIZE 79 MM DIA					
RW30	30-Compartment with Integrated Extender	73 mm	120 mm	14	4 ea
RW30-1	30-Compartment with 2 Extenders	73 mm	161 mm	14	3 ea
RW30-2	30-Compartment with 3 Extenders	73 mm	201 mm	14	2 ea
RW30-3	30-Compartment with 4 Extenders	73 mm	241 mm	14	2 ea
REW30S	30-Compartment Extender	73 mm	38 mm	14	6 ea
30-COMPARTMENT COLOR-CODED OPTICLEAN NEWAVE GLASS RACK - COMPARTMENT SIZE 79 MM DIA					
REW30SC	30-Compartment Divided Extender	90.4 mm	38 mm	04, 05, 09, 24, 89	6 ea
RW30-C	30-Compartment with Integrated Extender	73 mm	120 mm	410, 411, 412, 413, 414	4 ea
RW30-1C	30-Compartment with 2 Extenders	73 mm	161 mm	410, 411, 412, 413, 414	3 ea
RW30-2C	30-Compartment with 3 Extenders	73 mm	201 mm	410, 411, 412, 413, 414	2 ea
RW30-3C	30-Compartment with 4 Extenders	73 mm	241 mm	410, 411, 412, 413, 414	2 ea
RW30-4C	30-Compartment with 5 Extenders	73 mm	281 mm	410, 411, 412, 413, 414	1 ea

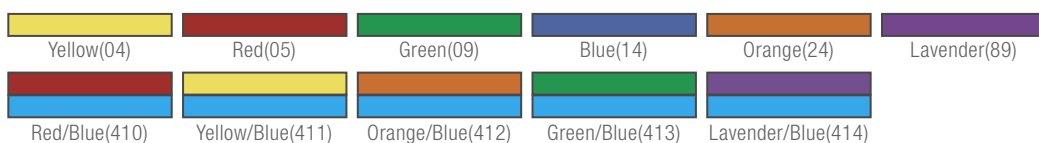

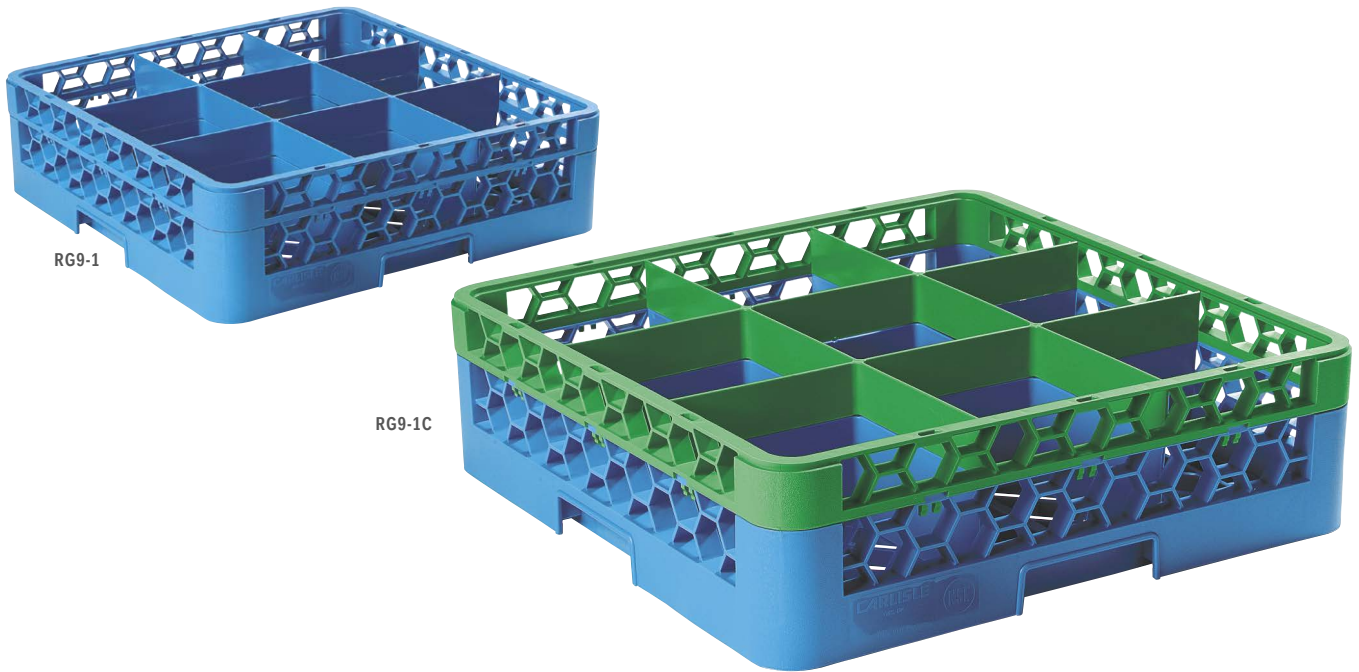

9-Compartment OptiClean Glass Racks

- Use with large brandy snifters, grande margaritas, carafes and other items with a wide diameter
- RE9, RE* and RE9C: not NSF listed

Prod No	Description	Glass Dia	Glass Height	Color	Case Pack
9-COMPARTMENT OPTICLEAN GLASS RACK — COMPARTMENT SIZE 148 MM SQUARE					
RG9	9-Compartment	141 mm	81 mm	14	6 ea
RG9-1	9-Compartment with 1 Extender	141 mm	120 mm	14	4 ea
RG9-2	9-Compartment with 2 Extenders	141 mm	161 mm	14	3 ea
RG9-3	9-Compartment with 3 Extenders	141 mm	201 mm	14	2 ea
RG9-4	9-Compartment with 4 Extenders	141 mm	241 mm	14	2 ea
RG9-5	9-Compartment with 5 Extenders	141 mm	281 mm	14	2 ea
RE9	9-Compartment Divided Extender	141 mm	241 mm	14	6 ea
RE*	Open Extender	—	38 mm	14	6 ea
9-COMPARTMENT OPTICLEAN COLOR-CODED GLASS RACK — COMPARTMENT SIZE 148 MM SQUARE					
RG9-1C	9-Compartment with 1 Extender	141 mm	120 mm	410, 411, 412, 413, 414	4 ea
RG9-2C	9-Compartment with 2 Extenders	141 mm	161 mm	410, 411, 412, 413, 414	3 ea
RG9-3C	9-Compartment with 3 Extenders	141 mm	201 mm	410, 411, 412, 413, 414	2 ea
RG9-4C	9-Compartment with 4 Extenders	141 mm	241 mm	410, 411, 412, 413, 414	2 ea
RG9-5C	9-Compartment with 5 Extenders	141 mm	281 mm	410, 411, 412, 413, 414	2 ea
RE9C	9-Compartment Divided Extender	141 mm	38 mm	04, 05, 09, 24, 89	6 ea
RE*	Open Extender	—	38 mm	14	6 ea

*Note: The RE Open Extender can be used with any OptiClean Glass or Dish Rack

**Dimensions shown are for the recommended maximum glass size for the compartment

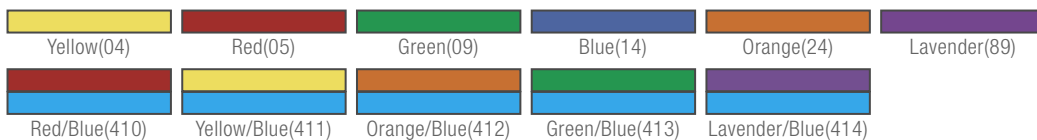

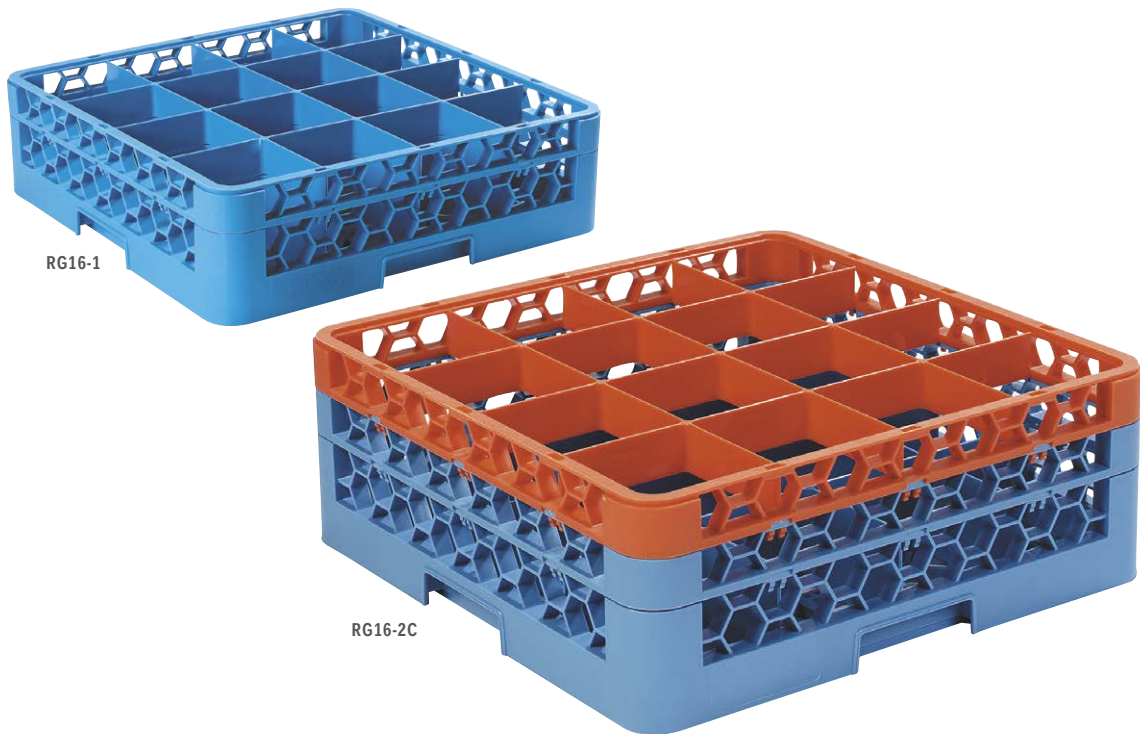

16-Compartment OptiClean Glass Racks

- Perfect for large cocktail glasses and delicate wine stems with oversize bowls
- RE16, RE* and RE16C: not NSF listed

Prod No	Description	Glass Dia	Glass Height	Color	Case Pack
16-COMPARTMENT OPTICLEAN GLASS RACK — COMPARTMENT SIZE 113 MM SQUARE					
RG16	16-Compartment	106 mm	81 mm	14	6 ea
RG16-1	16-Compartment with 1 Extender	106 mm	120 mm	14	4 ea
RG16-2	16-Compartment with 2 Extenders	106 mm	161 mm	14	3 ea
RG16-3	16-Compartment with 3 Extenders	106 mm	201 mm	14	2 ea
RG16-4	16-Compartment with 4 Extenders	106 mm	241 mm	14	2 ea
RG16-5	16-Compartment with 5 Extenders	106 mm	281 mm	14	2 ea
RE16	16-Compartment Divided Extender	106 mm	38 mm	14	6 ea
RE*	Open Extender	—	38 mm	14	6 ea
16-COMPARTMENT COLOR-CODED GLASS RACK — COMPARTMENT SIZE 113 MM SQUARE					
RG16-1C	16-Compartment with 1 Extender	106 mm	120 mm	410, 411, 412, 413, 414	4 ea
RG16-2C	16-Compartment with 2 Extenders	106 mm	161 mm	410, 411, 412, 413, 414	3 ea
RG16-3C	16-Compartment with 3 Extenders	106 mm	201 mm	410, 411, 412, 413, 414	2 ea
RG16-4C	16-Compartment with 4 Extenders	106 mm	241 mm	410, 411, 412, 413, 414	2 ea
RG16-5C	16-Compartment with 5 Extenders	106 mm	281 mm	410, 411, 412, 413, 414	2 ea
RE16C	16-Compartment Divided Extender	106 mm	38 mm	04, 05, 09, 24, 89	6 ea
RE*	Open Extender	—	38 mm	14	6 ea

*Note: The RE Open Extender can be used with any OptiClean Glass or Dish Rack

**Dimensions shown are for the recommended maximum glass size for the compartment

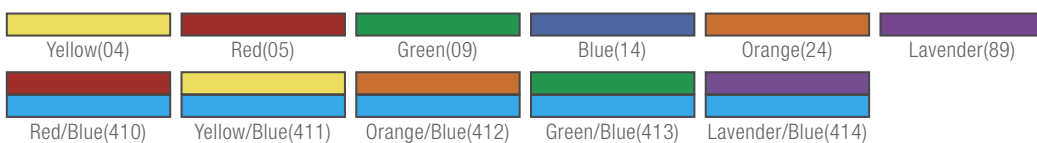



RG25-1

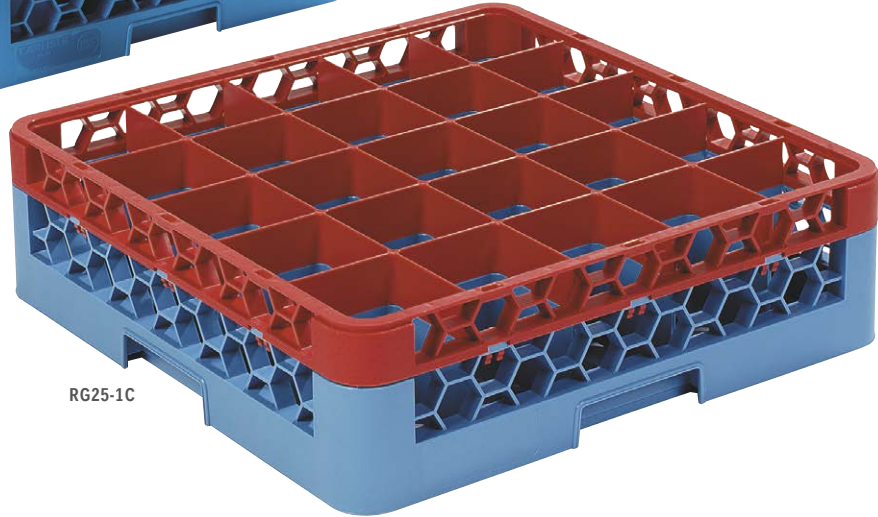

RG25-1C

25-Compartment OptiClean Glass Racks

- Use for large diameter beverage glasses, red wine stems, goblets and most rocks glasses
- RE25, RE* and RE25C: not NSF listed

Prod No	Description	Glass Dia	Glass Height	Color	Case Pack
25-COMPARTMENT OPTICLEAN GLASS RACK — COMPARTMENT SIZE 89 MM SQUARE					
RG25	25-Compartment	82 mm	81 mm	14	6 ea
RG25-1	25-Compartment with 1 Extender	82 mm	120 mm	14	4 ea
RG25-2	25-Compartment with 2 Extenders	82 mm	161 mm	14	3 ea
RG25-3	25-Compartment with 3 Extenders	82 mm	201 mm	14	2 ea
RG25-4	25-Compartment with 4 Extenders	82 mm	241 mm	14	2 ea
RG25-5	25-Compartment with 5 Extenders	82 mm	281 mm	14	2 ea
RE25	25-Compartment Divided Extender	82 mm	38 mm	14	6 ea
RE*	Open Extender	—	38 mm	14	6 ea
25-COMPARTMENT OPTICLEAN COLOR-CODED GLASS RACK — COMPARTMENT SIZE 89 MM SQUARE					
RG25-1C	25-Compartment with 1 Extender	82 mm	120 mm	410, 411, 412, 413, 414	4 ea
RG25-2C	25-Compartment with 2 Extenders	82 mm	161 mm	410, 411, 412, 413, 414	3 ea
RG25-3C	25-Compartment with 3 Extenders	82 mm	201 mm	410, 411, 412, 413, 414	2 ea
RG25-4C	25-Compartment with 4 Extenders	82 mm	241 mm	410, 411, 412, 413, 414	2 ea
RG25-5C	25-Compartment with 5 Extenders	82 mm	281 mm	410, 411, 412, 413, 414	2 ea
RE25C	25-Compartment Divided Extender	82 mm	38 mm	04, 05, 09, 24, 89	6 ea
RE*	Open Extender	—	38 mm	14	6 ea

*Note: The RE Open Extender can be used with any OptiClean Glass or Dish Rack

**Dimensions shown are for the recommended maximum glass size for the compartment

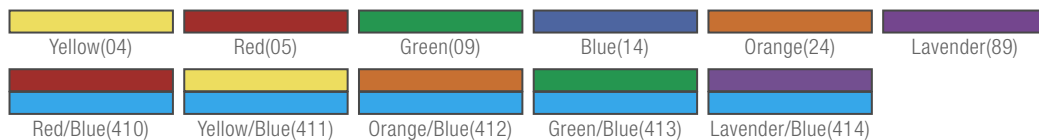

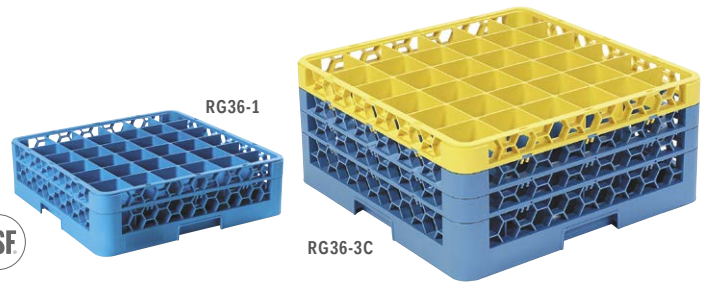

36-Compartment OptiClean Glass Racks



- Use with tumblers, white wine glasses and other narrow bowl stems
- RE36, RE* and RE36C: not NSF listed

Prod No	Description	Glass Dia	Glass Height	Color	Case Pack
36-COMPARTMENT OPTICLEAN GLASS RACK — COMPARTMENT SIZE 74 MM SQUARE					
RG36	36-Compartment	68 mm	81 mm	14	6 ea
RG36-1	36-Compartment with 1 Extender	68 mm	120 mm	14	4 ea
RG36-2	36-Compartment with 2 Extenders	68 mm	161 mm	14	3 ea
RG36-3	36-Compartment with 3 Extenders	68 mm	201 mm	14	2 ea
RG36-4	36-Compartment with 4 Extenders	68 mm	241 mm	14	2 ea
RG36-5	36-Compartment with 5 Extenders	68 mm	281 mm	14	2 ea
RE36	36-Compartment Divided Extender	68 mm	38 mm	14	6 ea
RE*	Open Extender	—	38 mm	14	6 ea
36-COMPARTMENT OPTICLEAN COLOR-CODED GLASS RACK — COMPARTMENT SIZE 74 MM SQUARE					
RG36-1C	36-Compartment with 1 Extender	68 mm	120 mm	410, 411, 412, 413, 414	4 ea
RG36-2C	36-Compartment with 2 Extenders	68 mm	161 mm	410, 411, 412, 413, 414	3 ea
RG36-3C	36-Compartment with 3 Extenders	68 mm	201 mm	410, 411, 412, 413, 414	2 ea
RG36-4C	36-Compartment with 4 Extenders	68 mm	241 mm	410, 411, 412, 413, 414	2 ea
RG36-5C	36-Compartment with 5 Extenders	68 mm	281 mm	410, 412, 413, 414	2 ea
RE36C	36-Compartment Divided Extender	68 mm	38 mm	04, 05, 09, 24, 89	6 ea

*Note: The RE Open Extender can be used with any OptiClean Glass or Dish Rack

**Dimensions shown are for the recommended maximum glass size for the compartment



49-Compartment OptiClean Glass Racks



- Ideal for juice glasses, narrow champagne flutes, cordials and shot glasses
- RE49, RE* and RE49C: not NSF listed

Prod No	Description	Glass Dia	Glass Height	Color	Case Pack
49-COMPARTMENT OPTICLEAN GLASS RACK — COMPARTMENT SIZE 73 MM SQUARE					
RG49	49-Compartment	54 mm	81 mm	14	6 ea
RG49-1	49-Compartment with 1 Extender	54 mm	120 mm	14	4 ea
RG49-2	49-Compartment with 2 Extenders	54 mm	161 mm	14	3 ea
RG49-3	49-Compartment with 3 Extenders	54 mm	201 mm	14	2 ea
RG49-4	49-Compartment with 4 Extenders	54 mm	241 mm	14	2 ea
RE49	49-Compartment Divided Extender	54 mm	38 mm	14	6 ea
RE*	Open Extender	—	38 mm	14	6 ea
49-COMPARTMENT OPTICLEAN COLOR-CODED GLASS RACK — COMPARTMENT SIZE 73 MM SQUARE					
RG49-1C	49-Compartment with 1 Extender	54 mm	120 mm	410, 411, 412, 413, 414	4 ea
RG49-2C	49-Compartment with 2 Extenders	54 mm	161 mm	410, 411, 412, 413, 414	3 ea
RG49-3C	49-Compartment with 3 Extenders	54 mm	201 mm	410, 411, 412, 413, 414	2 ea
RG49-4C	49-Compartment with 4 Extenders	54 mm	241 mm	410, 411, 412, 413, 414	2 ea
RG49-5C	49-Compartment with 5 Extenders	54 mm	281 mm	410, 411, 412, 413, 414	2 ea
RE49C	49-Compartment Divided Extender	54 mm	38 mm	04, 05, 09, 24, 89	6 ea

*Note: The RE Open Extender can be used with any OptiClean Glass or Dish Rack

**Dimensions shown are for the recommended maximum glass size for the compartment

OPTICLEAN DISH RACKS

- Offer the safest and most sanitary cleaning choices for everything from the most fragile tableware to heavy-duty kitchen items
- Offer all the same great features as the rest of Carlisle's wash racks
- Sturdy, double wall construction
- Comfort Curve™ Handles molded into all four sides



RTP

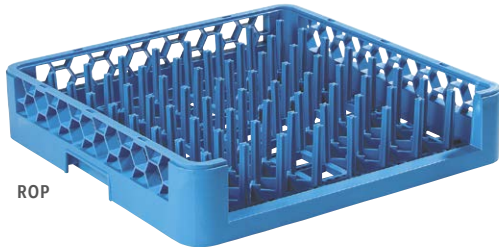

ROP

Peg Racks & Extender NSF

- Holds plates, trays and platters at the best angle to take full advantage of today's multiple spray, high-pressure dishwashers
- Plate locks hold dishes firmly in place to protect delicate rims, reduce chipping and breakage
- Use with additional Open Extenders (RE) to create the perfect rack for irregular or oversize drinkware
- Extra tall 7.5 cm pegs are ideal for charger plates, pasta bowls, large platters and trays
- Tall 7.5 cm pegs with open ended design hold all types of trays, standard size baking sheets and other long items
- RP and RE*: not NSF listed

Prod No	Description	Color	Case Pack
RP	All-Purpose Plate & Tray Rack	14	6 ea
RTP	Tall Peg Plate & Tray Rack	14	6 ea
ROP	Open End Peg Rack	14	6 ea
RE*	Open Extender	14	6 ea

*Note: The RE Open Extender can be used with any OptiClean Glass or Dish Rack

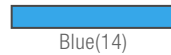

Blue(14)

Open/Bowl Rack & Extender NSF

- Sturdy open bottom rack is ideal for all large bowls, containers, brushes, cookware and cutlery
- RE*: not NSF listed

Prod No	Description	Color	Case Pack
RB	Open/Bowl Rack	14	6 ea
RE*	Open Extender	14	6 ea

*Note: The RE Open Extender can be used with any OptiClean Glass or Dish Rack

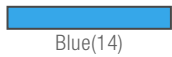

Blue(14)



RB

Combination/Flatware Rack

- Bottom grid allows for free flow of water and air
- Keeps flatware in place for thorough washing and drying
- Perfect for ramekins and other small items
- RE*: not NSF listed

Prod No	Description	Color	Case Pack
RF	Combination/Flatware Rack	14	6 ea
RE*	Open Extender	14	6 ea

*Note: The RE Open Extender can be used with any OptiClean Glass or Dish Rack



Blue(14)



RF

Cup Racks

- Tilted design promotes thorough washing of rims and interiors
- Encourages concaved bases to drain more efficiently, eliminating pooling water
- 16-Compartment holds larger diameter cups and mugs in tilted position; compartment size: 110 x 110 mm
- 20-Compartment works with most standard size cups; compartment size: 110 x 86 mm



RC20-1

Prod No	Description	Color	Case Pack
RC16	16-Compartment Cup Rack	14	6 ea
RC16-1	16-Compartment Cup Rack with 1 Open Extender	14	4 ea
RC20	20-Compartment Cup Rack	14	6 ea
RC20-1	20-Compartment Cup Rack with 1 Open Extender	14	4 ea

 Blue(14)

Bakery Tray & Sheet Pan Rack

- Rack securely holds sheet or bun pans low enough to fit standard height dish machine openings
- Contents are angled to take full advantage of multiple spray arms

Prod No	Description	Color	Case Pack
RSP	Bakery Tray & Sheet Pan Rack	14	3 ea

 Blue(14)



Food Pan/Insulated Meal Delivery Tray Rack

- Accommodates all sizes of 63 mm deep food pans and standard steam table inserts
- Racks are angled for thorough cleaning
- Perfect for health care or correctional facilities using insulated meal delivery compartment trays



Prod No	Description	Color	Case Pack
RFP	Food Pan/Insulated Meal Delivery Tray Rack	14	3 ea

 Blue(14)

Plate Cover Rack

- Use with plate covers, dishwasher safe insulated dome covers or dishwasher safe pellet bases
- Specially designed insert keeps contents separated during washing

Prod No	Description	Color	Case Pack
RPC	Plate Cover Rack	14	3 ea

 Blue(14)



OPTICLEAN ACCESSORIES

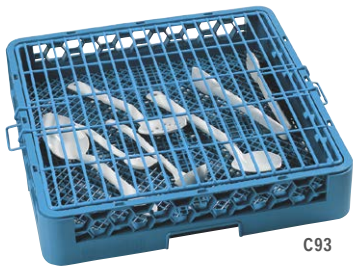

C93

Hold Down Grid

- Use with small, light-weight or delicate items to prevent them from being displaced by high pressure sprayers
- Snaps down securely and fits all OptiClean Glass & Dish Racks

Prod No	Description	Glass Height	Color	Case Pack
C93	Vinyl Coated Wire Grid	—	14	6 ea



Blue(14)

Half Size Stack-All™ Racks

- Compact 254 x 501 mm size will work in any 501 mm dishwasher
- Sturdy single wall construction
- Open design for superior water and air circulation
- Made of high impact polypropylene

Prod No	Description	Glass Height	Color	Case Pack
C135	Open Bowl/Cup/ Glass Rack	114 mm	14	6 ea
C111	Flatware Rack	114 mm	14	6 ea



Blue(14)

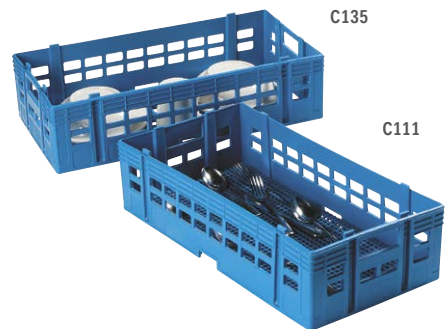

C135

C111

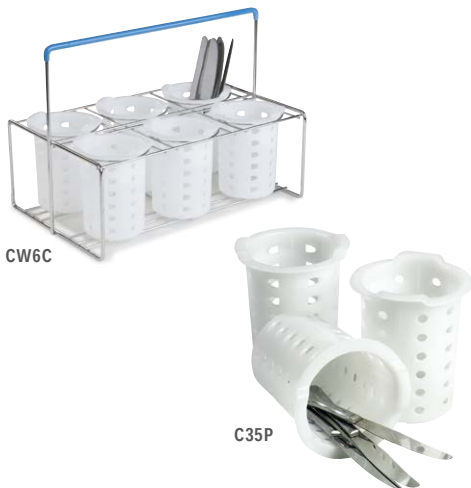

CW6C

C35P

Perma-Sil™ Cylinders & Carriers

- Cylinder has meshed bottom and open sides are best for the dispersion of water and air; ideal for washing or storing flatware
- Carrier has heavy gauge wire construction is chrome plated
- Carrier has vinyl-coated insulated handle

Prod No	Description	Color	Case Pack
C35P	Poly Cylinder	02	12 ea
CW6C	6-Compartment Portable Carrier	38	6 ea



White(02)

Chrome(38)

Perma-San™ Flatware Washing Baskets

- Open design for easy cleaning of vertically stored flatware
- Use with RF Flatware Rack or RB Open/Bowl Rack as part of a complete flatware sanitizing system
- Tough polypropylene material resists grease and detergents

Prod No	Description	Color	Case Pack
C32P1	Flatware Basket without Handles	14	6 ea
C32P2	Flatware Basket with Handles	14	6 ea



Blue(14)

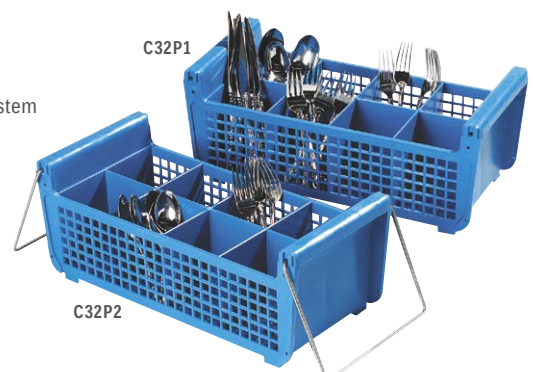

C32P1

C32P2

E-Z GLIDE™ RACK DOLLIES

Aluminum Dollies

- Hold and transport any 501 mm square stack of glass racks
- Large 101 mm ball bearing swivel casters with non-marking rubber wheels
- 136 kg weight capacity

Prod No	Description	Color	Case Pack
C2220A	Open Aluminum Dolly, No Handle	14	1 ea
C2222A	Open Aluminum Dolly with Handle	14	1 ea



Blue(14)

Polypropylene Dollies

- Injection molded dollies squared corners are designed to hold any standard 501 mm racks including older style square racks
- 158 kg weight capacity
- Dollies trap water from wet racks; convenient drain feature underneath the dolly makes emptying water easy

Prod No	Description	Color	Case Pack
C2236	Warewashing Rack Dolly, No Handle	03, 14	1 ea
C2236H	Warewashing Rack Dolly with Handle	03, 14	1 ea
C2237	Handle for C2236 & C2236H	03	1 ea
C2222C	Replacement Caster for C2220A & C2222A	00	1 ea
C2222HD	Handle for C2220A & C2222A	38	1 ea

Standard(00) Black(03) Blue(14) Chrome(38)

Rack Cover

- Hard cover protects rack contents during storage

Prod No	Description	Color	Case Pack
RHC	Rack Cover	02	1 ea

White(02)



Dust Covers

- Heavy-duty vinyl covers keep tableware clean during storage
- Easily converts warewashing racks into storage racks
- Combine with E-Z Glide Dollies and Rack Covers (shown left) for a complete storage system

Prod No	Description	Color	Case Pack
RDC	91 cm Long Rack Dust Cover	07	3 ea
RDC1	121 cm Long Rack Dust Cover	07	3 ea

Clear(07)



CARLISLE
FOODSERVICE PRODUCTS



FLOOR CARE

DUSTPANS AND SWEEPERS

- Lobby pans and brooms with sectional handles to give you over 50% reduction in carton size; lower cube saves warehouse space and shipping costs
- The lobby pans pivot and lock into place during use and release for easy carrying or emptying
- Handles feature a pivoting hanging hole at top for storage



361415

Duo-Pan™ Lobby Pan & Duo-Sweep Broom Combo



- Serrated edge allows you to comb the broom's bristles and drop debris into the pan
- Handy clip to attach broom for convenient storage
- 76.2 cm two-piece handle made from vinyl coated steel

Prod No	Description	Material	Style	Color	Pack
361415	Duo-Pan™ Lobby Pan & Duo-Sweep Broom Combo	Plastic	Lobby	03 (Black)	1 ea
361412	Broom Handle Clip for 361415	—	—	03 (Black)	12 ea

Duo-Pan™ II Lobby Pan & Broom Combo

- Adjustable position head for more functional use in corners and under counters or tables
- 3 piece, 76.2 cm handle
- Handy clip to attach broom for convenient storage
- Shelf-friendly packaging

Prod No	Description	Material	Style	Color	Pack
361416	Duo-Pan™ II Lobby Pan & Broom Combo	Plastic	Lobby	03 (Black)	4 ea



361416

FLOOR SQUEEGEES

- For uneven or smooth surfaces



Double Moss Foam Rubber with Metal Frame

- Moss Foam squeegee is designed for uneven, grouted and smooth surface floors

Prod No	Description	Handle	Color	Pack
366318	45 cm Soft Black Foam Rubber	2.4 cm Tapered	00	10 ea
366324	55.88 cm Soft Black Foam Rubber	2.4 cm Tapered	00	10 ea
366824	55.88 cm Soft Black Heavy-Duty Foam Rubber	Threaded	00	10 ea
366330	76.2 cm Reinforced Soft Black Foam Rubber	2.4 cm Tapered	00	10 ea



Double Foam Rubber Squeegee with Plastic Frame

- All plastic construction will not rust or bend and helps prevent hazard sparks when cleaning-up flammable fluids
- Available in colors to support HACCP compliance

Prod No	Description	Handle	Color	Pack
41567	45 cm Double Foam Rubber Floor Squeegee	Threaded	02, 04, 05, 09, 14, 24, 68	6 ea
41568	60.96 cm Double Foam Rubber Floor Squeegee	Threaded	02, 04, 05, 09, 14, 24, 68	6 ea

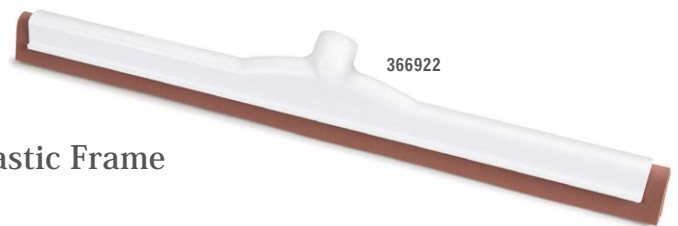

Double Moss Foam Rubber Squeegee with Plastic Frame

- Soft, double foam is fat and oil resistant
- All plastic construction will not rust or bend and helps prevent hazard sparks when cleaning-up flammable fluids

Prod No	Description	Handle	Color	Pack
366918	45 cm Red Foam Rubber	94" Threaded	00	10 ea
366922	55.88 cm Red Foam Rubber	94" Threaded	00	10 ea

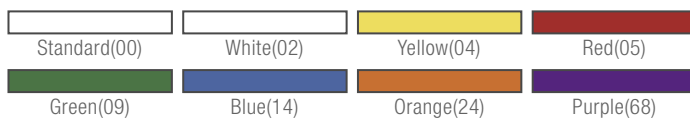

HANDLES SOLD SEPARATELY; SEE THE NEXT PAGE FOR OPTIONS!

HANDLES

- Durable for heavy usage



Color-Coded Fiberglass Handles

- For use with push brooms, sweeps, squeegees and floor scrubs
- Fiberglass handles are available in threaded, tapered/threaded and telescoping
- Self-Locking Flex-Tip Handle offers greater flexibility and reduces handle stress

Prod No	Description	Diameter	Style	Color	Pack
41226	183 cm Fiberglass Handle with Self-Locking Flex-Tip	25.4 mm	Threaded	00	12 ea
41225	121.92 cm Fiberglass Handle with Self-Locking Flex-Tip	25.4 mm	Threaded	00, 04, 05, 09, 14	12 ea
41291	91.44 cm Fiberglass Handle with Self-Locking Flex-Tip	25.4 mm	Threaded	00	12 ea
40225	152.4 cm Fiberglass Handle with Self-Locking Flex-Tip	25.4 mm	Threaded	01, 02, 03, 04, 05, 09, 14, 24, 25, 68	12 ea
40227	152.4 cm Solid Foam Filled Fiberglass Handle with Self-Locking Flex-Tip	25.4 mm	Tapered/Threaded	02, 04, 05, 09, 14	12 ea
40220	152.4 cm Fiberglass Handle	25.4 mm	Tapered/Threaded	01, 02, 04, 05, 09, 14	12 ea
40210	152.4 cm Economy Fiberglass Handle	23.876 mm	Female Threaded	02, 04, 05, 09, 14	12 ea
41020	137 to 244 cm Threaded Telescoping Fiberglass Handle	25.4 mm	Threaded Telescoping	01*, 02, 04, 05, 09, 14	12 ea

Color-Coded Stainless Steel Handle

- Color-Coded grip aligns with food safety (HACCP)
- Provide rigid stability
- Highly chemical resistant
- Standard threaded end

41199C - Stainless steel, available in 152.4 cm



Prod No	Description	Diameter	Style	Color	Pack
41199C	152 cm Stainless Steel Handle with Grip	25.4 mm	Threaded	02, 04, 05, 09, 14	6 ea

*Color available by special order only

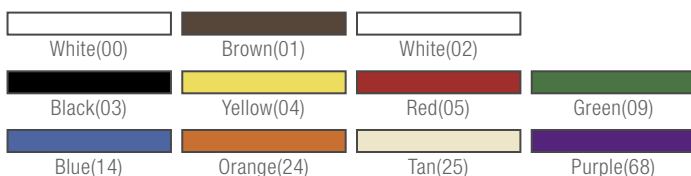

MOP BUCKETS & SIGNS

- Durable for heavy usage

Bucket & Wringer Combos

- Made of durable, corrosion resistant polyethylene
- Non-marking casters
- Available in 24.6 liter or 33 liter sizes

Prod No	Description	Color	Pack
36908	24.6 Liter Bucket with Side Press Wringer	04, 05, 09, 14, 69	1 ea
36904	33 Liter Bucket with Side Press Wringer	04, 05, 09, 14, 69	1 ea
36908W	Side Press Wringer for 24.6 and 33 Liter Mop Bucket	04, 05, 09, 14, 69	1 ea
36905	33 Liter Bucket with Down Press Wringer	04	1 ea
36908C	7.6 cm Swivel Casters for all Mop Buckets	00	2 ea



Wet Floor Signs

- Durable polypropylene
- Specially designed feet protect floor finishes
- 36900 locks into place to prevent collapsing
- Compact for easy storage

Prod No	Description	Color	Pack
36900	Floor Sign (English/Spanish)	00	6 ea
36909	Economy Wet Floor Sign (English/Spanish/German)	04	6 ea



Freestanding Caution Cone and Pop Up Caution Cone

- 360° visibility
- Caution message appears in English, Spanish and French
- Pop up Cone case can be mounted to wall for easy access

Prod No	Description	Color	Pack
36941	91.44 cm Caution Cone	04	3 ea
36942	50.8 cm Pop Up Caution Cone	04	12 ea





CARLISLE
FOODSERVICE PRODUCTS



TRANSPORTATION

CARTS

Fold 'N Go® Carts

- Folds up to store easily behind doors, between counters or back of delivery vans
- Solid legs and sturdy shelves hold up to 158.8 kg
- Cart ships fully assembled; no tools or complicated latches required
- Collapses to 22.86 cm width and 26.67 cm width
- 10.16 cm heavy-duty, non-marking swivel casters with molded-in metal reinforcement plates are permanently staked to 1.91 cm solid aluminum legs for longer life and added strength and rigidity



Prod No	Description	Weight Capacity	Color	Pack
SBC1521	38.1 cm x 53 cm Fold 'N Go Cart	158.8 kg	03, 23	1 ea
SBC2031	50.8 cm x 78.7 cm Fold 'N Go Cart	158.8 kg	03, 23	1 ea
SBCC240	Fold 'N Go Cart Replacement Caster, Swivel	—	00	1 ea
SBCC245	Fold 'N Go Cart Replacement Caster, Swivel with Brake	—	00	1 ea
SBCA30000	Fold 'N Go Cart Replacement Slide Bracket Assembly	—	—	1 ea
SBCRKIT	Fold 'N Go Hardware Replacement Kit (includes 2 casters)	—	—	1 ea

Licensed Product under U.S. Patent No. 5806864

Bussing Carts

- Durable construction stands up to the toughest use
- Molded on handles that will not come apart when rolling over bumps and uneven surfaces
- Raised edges on shelves for quick loading and protect from spills and accidents

Prod No	Description	Weight Capacity	Color	Pack
CC2243	42" x 23" Large Bussing Cart	136 kg	03	1 ea
CC2036	45 x 91.44 cm Bussing Cart	136 kg	03	1 ea
CC2036DP	45 x 91.44 cm Bussing Cart with Doors and Back Panels	136 kg	03	1 ea
CC2036P	45 x 91.44 cm Bussing Cart with Back Panels	136 kg	03	1 set
CD2036	45 x 91.44 cm Doors and Back Panels Only	—	03	1 set
CP2036	45 x 91.44 cm Back Panels Only	—	03	1 set
CC11SH	Accessory Bin for Bussing Cart	—	03	1 ea
CC11TH	Trash Bin for Bussing Cart	—	03	1 ea

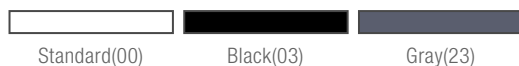

JANITORIAL CARTS & ACCESSORIES

- Rugged polypropylene resists cracking, peeling and corrosion
- Three durable shelves with raised edges keep items organized
- Platform base holds a Bucket/Wringer or 87 liter TrimLine™ Waste Container
- Includes a 95 liter nylon bag for waste or laundry collection
- 76.2 mm standard Carlisle non-marking swivel casters in front; large
- 203.2 mm non-marking rear wheels



Integrated tool holders, shelves and hooks keep everything organized including unwieldy handles.



Front hooks hold most standard Wet Floor Signs. Built-in hanger holds multiple spray bottles.



Structurally reinforced base and heavy-duty casters/wheels withstand rough use - holds up to 136 kg



Tough 95 liter nylon bag easily attaches to cart arm. Hooks on top of arm to hold trash liners in place. Arm swings up for more compact storage when not in use.



JC1945S

Janitorial Carts and Accessories

Prod No	Description	Weight Capacity	Color	Pack
JC1945S	114.3 L x 48.3 W x 99.06 cm H Short Platform Janitorial Cart	136 kg	23	1 ea
JC1945L	124.4 L x 48.3 W x 99.1 cm H Long Platform Janitorial Cart	136 kg	23	1 ea
JC1946	Replacement Bag for JC1945S & JC1945L	—	14	1 ea
36908C	76.2 mm Replacement Casters	—	00	2 ea

Tool Caddy

- Handled caddy fits in the top compartment of the JC1945 cart series
- Deep compartments prevent spills
- Made of durable polypropylene

Prod No	Description	Color	Pack
JC1945CB	Tool Caddy for Janitorial Cart	23	1 ea



JC1945CB



DISH DOLLIES

Optimizer Adjustable Dish Dolly Guide

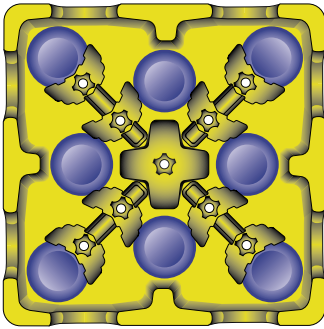

ADS8 Layout for 13.9 cm round plates

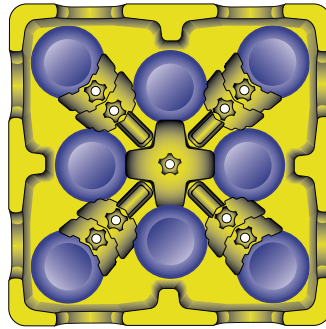

ADS8 Layout for 16.51 cm round plates

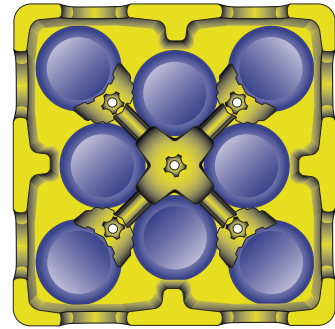

ADS4 Layout for 19.05 cm round plates and 15.24 cm square plates

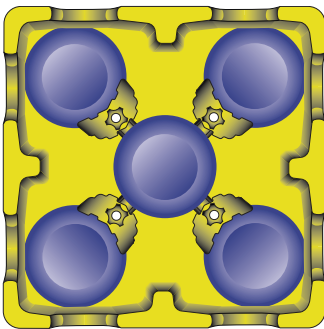

ADS4 Layout for 22.9 cm round plates

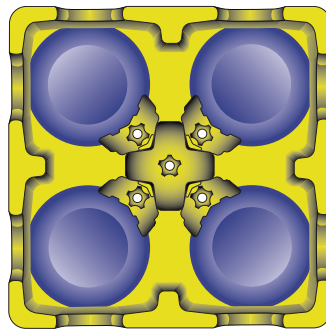

ADS4 Layout for 27.94 cm round plates and 21.6 cm square plates

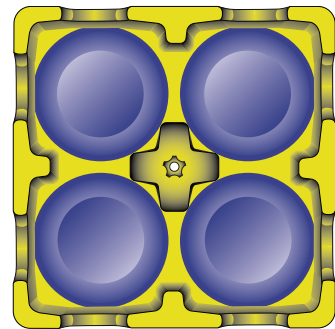

ADS4 Layout for 30 cm round plates

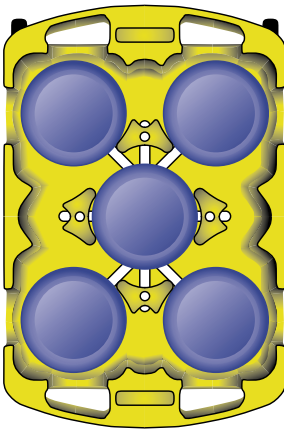

ADD4 Layout for 25.1 cm to 28.58 cm round plates

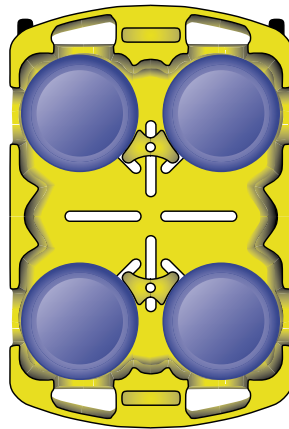

ADD4 Layout for 29 cm to 31.75 cm round plates, 21.6 cm to 26.7 cm square plates and 34.29 cm by 26.7 cm platters

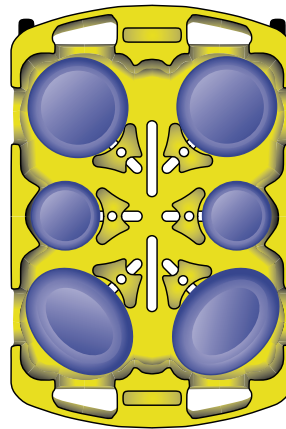

ADD6 Layout for 30 cm by 22.9 cm to 24 cm by 18.42 cm platters, 13.9 cm to 20.3 cm and 13.9 cm to 30 cm round plates

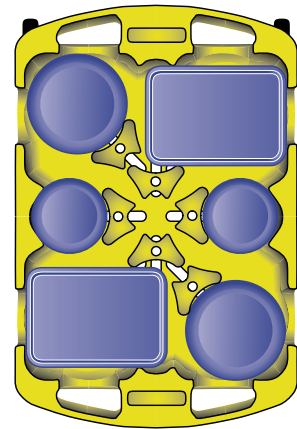

ADD6 Layout for 25.4 cm by 36.8 cm trays and 19.05 cm and 25.4 cm round plates

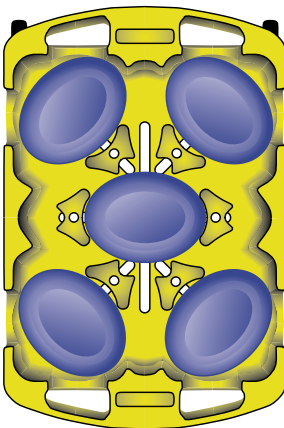

ADD6 Layout for 30 cm by 23.5 cm to 24 cm by 18.42 cm platters

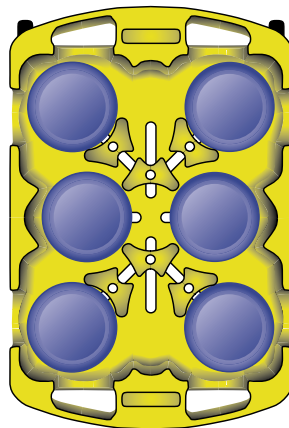

ADD6 Layout for 21.3 cm to 24.8 cm round plates

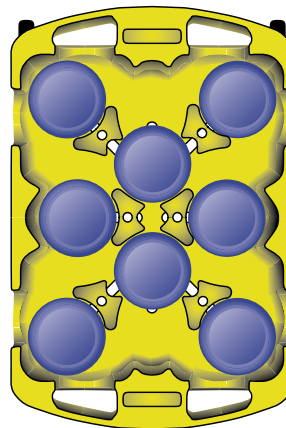

ADD6 Layout for 20.3 cm to 20.96 cm round plates

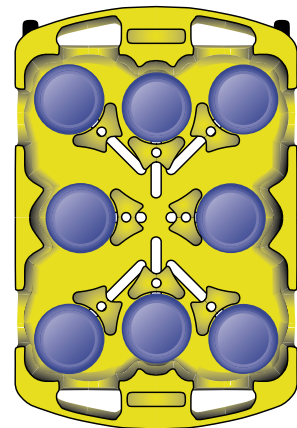

ADD6 Layout with 2 Additional Dividers for 13.9 cm to 20 cm round plates



ADD4



ADS4

Optimizer™ Adjustable Dish Dollies NSF

- Adjustable dividers eliminate the need for individually sized dollies
- Dollies hold plates from 13.97 cm to 31.75 cm
- Polyethylene dividers and walls help prevent dish edge chipping
- Two-handed access to all plates reduces breakage
- Non-marking casters (2 locking, 2 non-locking) for easy transport of loaded dollies
- Includes vinyl cover with easy-opening hook & loop side included for sanitary storage

Prod No	Description	Color	Pack
NSF			
OPTIMIZER STANDARD			
ADD4	Optimizer Dish Dolly with 4 Dividers	01*, 03	1 ea
ADD6	Optimizer Dish Dolly with 6 Dividers	01*, 03	1 ea
ADD	Optimizer Replacement Dividers (Set of 2)	01, 03	2 ea
OPTIMIZER SMALL			
ADS4	Optimizer Small Dish Dolly and 4 Adjustable Dividers	03	1 ea
ADS8	Optimizer Small Dish Dolly and 8 Adjustable Dividers	03	1 ea
ADSD	Optimizer Replacement Dividers (Set of 4)	03	1 ea

Note: ADD4, ADD6, ADS4, ADS8 cannot ship UPS/FedEx

*Color available by special order only



ADDC Vinyl Cover with ADD6

Optimizer Vinyl Replacement Covers

Prod No	Description	Color	Pack
ADDC	Vinyl Replacement Cover for Optimizer STANDARD (for ADD4 or ADD6)	07	1 ea
ADSC	Vinyl Replacement Cover for Optimizer SMALL (for ADS4 or ADS8)	07	1 ea

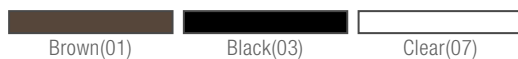





WASTE MANAGEMENT

WASTE CONTAINERS & LIDS

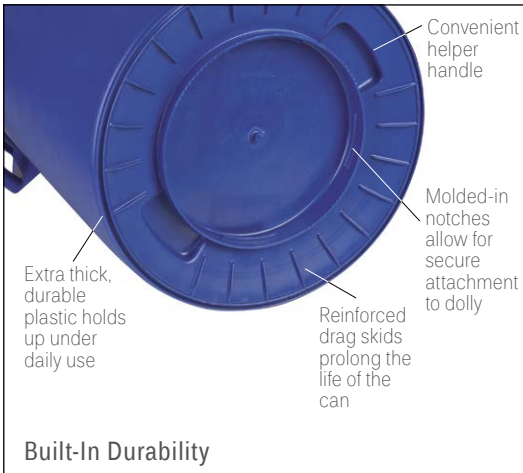

Bronco™  

- Heavy-duty construction with double-reinforced stress ribs; drag skids for durability
- Comfort Curve™ handles provide easy handling
- Helper handles on base for controlled tipping or overhead lifting
- Reinforced lids have snap down tab locks with a simple press & pull release system for easy removal
- NSF Std 21 – meets the criteria for thermoplastic refuse containers
- NSF Std 2 – meets the criteria for food contact and cleanability
- 341034, 341035 and 341057: not NSF listed

Prod No	Description	Color	Case Pack
341010	37.8 L Waste Container, 40.9 x 43.1 cm	02, 03, 04, 05, 09, 14, 23, 24, 89*	6 ea
341011	37.8 Lid, 40.9 x 5 cm	02, 03, 04, 05, 09, 14, 23, 24, 89	6 ea
341020	75.7 L Waste Container, 50.8 x 58.4 cm	02, 03, 04, 05, 09, 14, 23, 24, 89*	6 ea
341021	75.7 L Lid, 50.8 x 5.4 cm	02, 03, 04, 05, 09, 14, 23, 24, 89*	6 ea
341032	121.1 L Waste Container, 56.8 x 70.4 cm	02, 03, 04, 05, 09, 14, 23, 24, 89	4 ea
341033	121.1 L Lid, 60.9 x 5.4 cm	02, 03, 04, 05, 09, 14, 23, 24, 89	4 ea
341034	121.1 L Dome Lid	03	1 ea
341035	121.1 L Funnel Lid	03	4 ea
341044	166.5 L Waste Container, 68.2 x 79.7 cm	02, 03, 04, 05, 09, 14, 23, 24, 89	3 ea
341045	166.5 L Lid, 68.2 x 5.7 cm	02, 03, 04, 05, 09, 14, 23, 24, 89	3 ea
341055	208.1 L Waste Container, 67.3 x 83.8 cm	02, 03, 04, 05, 09, 14, 23, 89*	2 ea
341056	208.1 L Lid, 67.3 x 8.7 cm	02, 03, 04, 05, 09, 14, 23, 89*	2 ea
341057	166.5/208.1 L Dome Lid	03	1 ea
341132	121.1 L Container with Dolly, 56.8 x 97.1 cm	02, 04, 05, 09, 14, 23	4 ea
341144	166.5 L Container with Dolly, 68.2 x 95.8 cm	02, 04, 05, 09, 14, 23	3 ea

* Color available by special order only

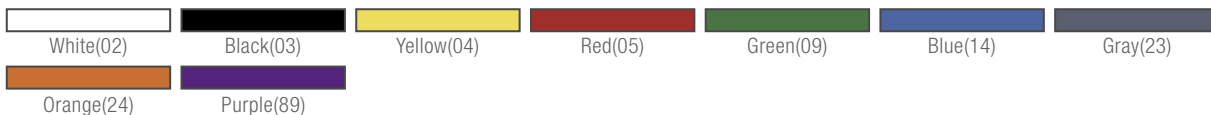

Carlisle Dollies

- Dollies fit our 75.7, 121.1, 166.5 and 208.1 liter containers for safe transport of heavy loads
- Simple twist-to-lock feature securely attaches dolly to containers
- Dollies include standard Carlisle non-marking 76.2 mm swivel casters
- NSF Std 2—meets the criteria for food contact and cleanability
- 3672231: not NSF listed

Prod No	Description	Color	Pack
36911	Standard Round Container Dolly, 45 x 15.2 cm	03 (Black)	2 ea
36910	Round Container Dolly with Replaceable Casters	03 (Black)	2 ea
3672231	76.2 mm Replacement Caster for 36910 Dolly	—	1 ea



189.2 L Roll-Away Container

- Super heavy-duty axle and oversize traction wheels make hauling heavy loads easy
- Unique handle design gives positive grip even when wet
- Sturdy hinged lid flips open 132°C and snaps shut tight
- NSF Std 21 – meets the criteria for thermoplastic refuse containers
- NSF Std 2 – meets the criteria for food contact and cleanability

Prod No	Description	Color	Pack
345050	189.2 L Rolling Container, 53.3 x 53.3 x 97.1 cm	14, 23	2 ea



INDEX BY PART NUMBER

Prod No	Page No	Prod No	Page No	Prod No	Page No	Prod No	Page No
5CC55PC.....	103	807FB*.....	42	1318FMT.....	111	2512.....	112
5CC118MP-12.....	103	807FBPK.....	42	1319BT.....	135	2618DFGQ.....	134
5CC120MP-12.....	103	810CM15.....	48	1400GL.....	138	2618FGQ.....	134
5CC200PC-12.....	103	810CM17.....	48	1400GR2.....	138	2618FMTQ.....	111
5CCCCLIP-12.....	103	810PM15.....	48	1410DFG.....	134	2618WFGQ.....	134
5CCLCLIP-12.....	103	810PM17.....	48	1410FG.....	134	2700GR2.....	138
0120.....	86	813TM.....	48	1410WFG.....	134	3004.....	112
0132.....	86	813TM-SB.....	48	1418LDFG.....	134	3042.....	128, 129
0240.....	121	817TM.....	48	1418LFG.....	134	3100GR2.....	138
0261.....	121	817TM-BR.....	48	1419DFG.....	134	3253GR2.....	138
269DFG.....	134	817TM-SB.....	48	1419FG.....	134	3956.....	152
269FG.....	134	0820.....	99	1419WFG.....	134	3957.....	152
269FMT.....	111	824TM.....	48	1520LDFG.....	134	3958.....	152
269WFG.....	134	0830.....	99	1520LFG.....	134	3959.....	152
0287.....	121	830FMT.....	111	1520LWFG.....	134	3960.....	152
0295.....	121	0831.....	99	1600GL.....	138	3961.....	152
0296.....	121	0843.....	99	1600GR2.....	138	3970.....	152
0300.....	120	0844.....	99	1612DFG.....	134	3971.....	152
0301.....	120	0845.....	99	1612FG.....	134	3980.....	152
0302.....	120	0852.....	98	1612WFG.....	134	3981.....	152
0304.....	120	0855.....	97	1713DFG.....	134	3990.....	152
0316.....	120	0860.....	96	1713FG.....	134	3991.....	152
0341.....	120	0862.....	96	1713WFG.....	134	3992.....	152
0342.....	120	0864.....	97	1814DFG.....	134	3993.....	152
0343.....	120	0873.....	98	1814FG.....	134	4006.....	120
0362.....	99	0875.....	98	1814GR2.....	138	4008.....	86
410.....	96	0878.....	98	1814WFG.....	134	4009.....	120
412.....	96	1000B.....	106	1826GR2Q.....	138	4010.....	86
414.....	96	1030FMT.....	111	1900.....	79	4012.....	86
0470.....	100	1100GL.....	138	1960.....	79	4016.....	86
0475.....	100	1100GR2.....	138	1965.....	79	4020.....	86
509.....	121	1104.....	86	1987.....	79	4029.....	86
614.....	136	1105.....	86	1989.....	79	4033.....	88
614DVA - WH20.....	55	1108.....	86	1991.....	79	4034.....	88
614PC.....	136	1110.....	86	1992.....	79	4035.....	88
614R.....	136	1112.....	86	1993.....	79	4109.....	120
615.....	136	1116.....	86	1994.....	79	4206.....	120
630FMT.....	111	1212FG.....	134	2015DFG.....	134	4230.....	153
0700.....	101	1212WFG.....	134	2015FG.....	134	4231.....	153
0703.....	101	1216LDFG.....	134	2015GR2.....	138	4250.....	153
0707.....	101	1216LFG.....	134	2015WFG.....	134	4251.....	153
0710.....	101	1216LWFG.....	134	2115DFG.....	134	4260.....	153
0713.....	101	1217BT.....	135	2115FG.....	134	4261.....	153
0717.....	101	1218FMT.....	111	2115WFG.....	134	4270.....	153
800FG13.....	49	1219LDFG.....	134	2214DFG.....	134	4271.....	153
800FG13-BK.....	49	1219LFG.....	134	2214FG.....	134	4306.....	131, 155
800FG15.....	49	1219LWFG.....	134	2214WFG.....	134	4315.....	149
800FG15-BK.....	49	1220FG.....	134	2216FGQ.....	134	4322.....	151
800FG17.....	49	1220WFG.....	134	2216GR2Q.....	138	4324.....	151
800FG17-BK.....	49	1222LDFG.....	134	2216WFGQ.....	134	4326.....	151
800FG24.....	49	1222LFG.....	134	2310DFG.....	134	4328.....	151
800FG24-BK.....	49	1222LWFG.....	134	2310FG.....	134	4329.....	151
801SG13.....	49	1230FMT.....	111	2310WFG.....	134	4330.....	151
801SG15.....	49	1318DFG.....	134	2500.....	99	4332.....	155
801SG17.....	49	1318FG.....	134	2500GR2.....	138	4355.....	121

Prod No	Page No	Prod No	Page No	Prod No	Page No	Prod No	Page No
4358	151	4932	152	5609	82	7920	109
4360	151	4933	152	5610	82	8004	91
4360-5	151	4961	152	5612	82	8104	91
4361	151	4962	152	5614	82	8302FMT	111
4362	151	4963	152	5616	82	8919	109
4364	155	4964	152	5640	82	8920	109
4370	151	4965	152	5641	82	10145	137
4370-5	151	4966	152	5642	82	10200B	158
4371	151	4967	152	5643	82	10201B	158
4380	151	4968	152	5644	82	10202B	158
4380-5	151	5024CE29AF	103	5645	82	10203B	158
4381	151	5024EG29AF	103	5646	82	10210U	158
4381-5	151	5024FW29AF	103	5648	82	10211U	158
4390	151	5105-2	88	5649	82	10212B	158, 160
4390-5	151	5108-2	88	5650	82	10215	158
4391	151	5109-2	88	5651	82	10216U	158
4410	121	5116-2	88	5652	82	10217U	158
4411	121	5120	88	5806	85	10220B	158
4415	154	5212	84	5808	85	10221B	158
4416	154	5212-2	84	5810	85	10222B	158
4420	121	5216	84	5812	85	10223B	158
4421	121	5216-2	84	5814	85	10230U	158
4425	154	5220	84	5816	85	10231U	158
4426	154	5220-2	84	5818	85	10232B	158, 160
4430	121	5224	84	5820	85	10235	158
4431	121	5232	84	5822	85	10236U	158
4450	121	5501	84	5832	85	10238Z	159
4460	121	5501-2	84	5865	136	10239Z	159
4470	121	5505	87	5933	78, 107	10240B	158
4471	121	5506	84	6031	153	10240Z	159
4512	91	5506-2	84	6302FMT	111	10241B	158
4530	78	5508	87	6413	111	10250U	158
4531	78	5509	87	6416	111	10256U	158
4532	78	5512	87	6417	111	10270U	158
4533	78	5517	87	6426	111	10271U	158
4534	78	5519	87	6439	111	10276U	158
4535	78	5526	84	6450	111	10277U	158
4553	98	5526-2	84	6786RMT	50	10278Z	159
4606	120	5529	84	6786RMT-XL	50	10279Z	159
4609	120	5529-2	84	6982	110	10280Z	159
4709	120	5532	84	6982L	110	10290U	158
4712	120	5532-2	84	6984	110	10291U	158
4806	120	5536	92	6984L	110	10296U	158
4900	154	5538	92	6986	110	10297U	158
4921	152	5540	92	6988	110	10302FMT	111
4922	152	5544	92	6990	110	10310U	158
4923	152	5546	92	7000	90	10311U	158
4924	152	5547	92	7550	126	10316U	158
4925	152	5570	93	7555	126	10317U	158
4926	152	5573	93	7910	109	10318Z	159
4927	152	5583	93	7913	109	10319Z	159
4928	152	5587	93	7914	109	10335	158
4929	152	5601	82	7916	109	10336U	158
4930	152	5602	82	7918	109	10337U	158
4931	152	5603	82	7919	109	10338Z	159

INDEX BY PART NUMBER

Prod No	Page No	Prod No	Page No	Prod No	Page No	Prod No	Page No
10339Z	159	10628	162	30687	158	38883G	122
10400B	160	10629	162	30688	158	38884G	122
10401B	160	10720	164	30689	158	40210	182
10402B	160	10720-307	164	30695	158	40220	182
10410U	160	10721	164	30860	160	40225	182
10411U	160	10721-307	164	30860H	161	40227	182
10415	160	10722	164	30860HH	161	40350C	154
10416U	160	10722-207	164	30861	160	40352C	154
10417U	160	10723	164	30861H	161	40353C	154
10420B	160	10723-207	164	30861HH	161	40361C	154
10421B	160	10724	164	30862	160	41020	182
10422B	160	10725	164	30869	160	41199C	182
10423B	160	10726	164	30870	160	41225	182
10430U	160	10730	164	30871	161	41226	182
10431U	160	10730-302	164	30880	160	41291	182
10435	160	10731	164	30881	160	41567	181
10436U	160	10731-302	164	30882	160	41568	181
10437U	160	10732	164	30883	160	43024	108
10438Z	161	10732-202	164	30884	160	43066	91
10439Z	161	10733	164	30885	160	43068	91
10440B	160	10733-202	164	30886	160	43121	99
10440Z	161	10734	164	30887	160	43122	99
10441B	160	10735	164	30888	160	43123	99
10450U	160	10736	164	30895	160	43125	98
10470U	160	10740	164	30896	160	43126	99
10471U	160	10741	164	33302	107	43141	149
10476U	160	10742	164	33310	107	43142	149
10477U	160	10761	165	33312	107	43143	149
10478Z	161	10763	165	33314	107	43144	149
10479Z	161	10764	165	33316	107	43145	149
10480Z	161	10765	165	33318	107	43620	83
10490U	160	10766	165	33320	107	43621	83
10491U	160	10767	165	33322	107	43622	83
10496U	160	10768	165	33324	107	43623	83
10510U	160	10769	165	33326	107	43624	83
10511U	160	10770	165	33360	106	43625	83
10516U	160	10771	165	33362	106	43626	83
10518Z	161	10772	165	33364	106	43627	83
10519Z	161	10773	165	36900	183	43628	83
10535	160	30580	158, 160	36904	183	43629	83
10536U	160	30581	158, 160	36905	183	43630	83
10537U	160	30582	158, 160	36908	183	43631	83
10538Z	161	30583	158, 160	36908C	183, 187	43633	89
10539Z	161	30660	158	36908W	183	43635	89
10610	162	30661	158	36909	183	43636	89
10611	162	30662	158	36910	193	43637	89
10611C	162	30669	158	36911	193	43638	89
10612	162	30670	158	36941	183	43640	89
10617	162	30680	158	36942	183	43647	85
10620	162	30681	158	38655	119	43648	85
10621	162	30682	158	38800GLC	123	43649	85
10622	162	30683	158	38820C	122	43651	85
10623	162	30684	158	38830C	122	43653	85
10624	162	30685	158	38850GEW	122	43655	85
10627	162	30686	158	38882G	122	43662	89

Prod No	Page No	Prod No	Page No	Prod No	Page No	Prod No	Page No
43663.....	89	53004.....	74	60300-8.....	150	361415.....	180
43664.....	89	53005.....	74	60300-10.....	150	361416.....	180
43665.....	89	53006.....	74	60300-12.....	150	366318.....	181
43666.....	89	53007.....	74	60300-16.....	150	366324.....	181
43668.....	89	53008.....	74	60300-20.....	150	366330.....	181
43674.....	89	53009.....	74	60300-24.....	150	366824.....	181
43737.....	107	53010.....	74	60300-30.....	150	366918.....	181
43738.....	107	53011.....	74	60300-40.....	150	366922.....	181
43739.....	107	53101.....	74	64001.....	76	388804L.....	123
43745.....	107	53102.....	74	64002.....	76	602400.....	99
43772.....	107	53103.....	74	64003.....	76	602500.....	99
43800.....	78	53104.....	74	64005.....	76	604360.....	150
43801.....	78	53105.....	74	64007.....	76	604361.....	150
43803.....	78	53106.....	74	64013.....	76	604370.....	150
43806.....	78	53107.....	74	64018.....	76	604371.....	150
43813.....	78	53108.....	74	64020.....	76	604380.....	150
43814.....	78	53109.....	74	64022.....	76	604381.....	150
43822.....	78	53110.....	74	64023.....	76	604390.....	150
43840.....	107	54001.....	76	69844.....	110	604392.....	150
43842.....	107	54002.....	76	69846.....	110	606040.....	155
43937.....	84	54003.....	76	69864.....	110	606055.....	155
43942.....	97	54004.....	76	69866.....	110	606086.....	155
43943.....	97	54005.....	76	70900.....	90	606106.....	131
43944.....	97	54007.....	76	70901.....	90	1178902.....	26
43965.....	91	54018.....	76	70902.....	90	1179944.....	26
43980.....	136	54019.....	76	70903.....	90	3672231.....	193
43981.....	136	55520.....	106	70904.....	90	439945200.....	87
43982.....	136	55522.....	106	70905.....	90		
43983.....	136	55524.....	106	91020.....	79	A	
43984.....	137	55526.....	106	91040.....	79	ADD4.....	189
43986.....	137	55528.....	106	91055.....	79	ADD6.....	189
43988.....	136	55530.....	106	91065.....	79	ADDC.....	189
43989.....	136	55532.....	106	91070.....	79	ADDD.....	189
44400.....	108	55534.....	106	91075.....	79	ADS4.....	189
44402.....	108	55536.....	106	91080.....	79	ADS8.....	189
44404.....	108	55538.....	106	91085.....	79	ADSC.....	189
44406.....	108	55540.....	106	91090.....	79	ADSD.....	189
44410.....	108	55542.....	106	91095.....	79	ARR112.....	107
44410C.....	108	55544.....	106	341010.....	192	ARR120.....	107
44412.....	108	55546.....	106	341011.....	192	ARR240.....	107
44414.....	108	55550.....	106	341020.....	192	ASZ121812SYS.....	27
44414C.....	108	60200.....	113	341021.....	192	ASZTHERMW.....	27
44416.....	108	60201.....	113	341032.....	192		
44418.....	108	60202.....	113	341033.....	192	B	
44420.....	108	60203.....	113	341034.....	192	BD100S.....	40
44422.....	108	60204.....	113	341035.....	192	BD101.....	40
44430.....	108	60205.....	113	341044.....	192	BD102.....	40
44432.....	108	60206.....	113	341045.....	192	BD103.....	40
44432C.....	108	60207.....	113	341055.....	192	BD104.....	40
44460.....	108	60208.....	113	341056.....	192	BD105.....	40
44462.....	108	60209.....	113	341057.....	192	BD106.....	40
53000.....	74	60210.....	113	341132.....	192	BD110.....	40
53001.....	74	60211.....	113	341144.....	192	BD2001.....	39
53002.....	74	60300.....	150	345050.....	193	BD2002.....	39
53003.....	74	60300-6.....	150	361412.....	180	BD2002CAR.....	39

INDEX BY PART NUMBER

Prod No	Page No	Prod	No	Page No	Prod No	Page	No	Prod No	Page No		
BD2003.....	39		C3200EF.....	6			CBG912PR.....	27		CM1101.....	117
BD2004CAL.....	39		C3200EH.....	6			CBG6938BK.....	43		CM1101C14.....	116
BD2004NL.....	39		C3200EV.....	6			CBG6938GN.....	43		CM1102.....	117
BD4003.....	38		C3200P.....	6			CBG6938PR.....	27		CM1102C14.....	116
BD4004.....	38		C3250SS.....	7			CBG6938RD.....	43		CM1103.....	117
BD4005E.....	38		C3260*.....	7			CBG6938WH.....	43		CM1103C14.....	116
BD4005S.....	38		C3400EF.....	6			CBG6938YL.....	43		CM1104.....	117
BD4006S.....	38		C3400EH.....	6			CBG121812*.....	24		CM1104C14.....	116
BD4014.....	38		C3400EV.....	6			CBG121812BL.....	24		CM1105.....	117
BD4023S.....	38		C3400P.....	6			CBG121812BR.....	24		CM1105C14.....	116
BDRX400.....	40		C3450SS.....	7			CBG121812GN.....	24		CM1107.....	117
BDS2203.....	39		C3500EF.....	6			CBG121812PR.....	27		CM1108.....	117
BDS2204NL.....	39		C3500EH.....	6			CBG121812RD.....	24		CM1125.....	117
BDS2401NL.....	39		C3500EV.....	6			CBG121812WH.....	24		CM1126.....	117
BDS2483NL.....	39		C3500P.....	6			CBG121812YL.....	24		CM1127.....	117
BDS4206.....	39		C3604.....	12			CBG152012*.....	24		CM1128.....	117
BDS4266.....	39		C3620.....	12			CBG152012BL.....	24		CM1400.....	119
BDSX100.....	39		C3620W.....	111, 139			CBG152012BR.....	24		CM1401.....	119
			C3625T.....	111, 139			CBG152012GN.....	24		CM1402.....	119
			C3630W.....	111, 139			CBG152012PR.....	27		CM1403.....	119
C			C4150SS.....	7			CBG152012RD.....	24		CM1404.....	119
C22XC.....	8		C4160*.....	7			CBG152012WH.....	24		CM1405.....	119
C24XC.....	8		C4180*.....	7			CBG152012YL.....	24		CM1406.....	119
C32P1.....	176		C5250C.....	10			CBG182412*.....	24		CM1407.....	119
C32P2.....	176		C5250C18.....	10			CBM1016.....	26		CM1408.....	119
C35P.....	176		C5250SM.....	10			CBM1318.....	26		CM10238Z.....	118
C52XC.....	11		C5450C.....	10			CBM1622.....	26		CM10239Z.....	118
C54XC.....	11		C5450C18.....	10			CBMASZ1212.....	27		CM10240Z.....	118
C93.....	176		C5450SM.....	10			CBMASZ2430.....	27		CM10278Z.....	118
C111.....	176		C6200C.....	6			CC11SH.....	186		CM10279Z.....	118
C135.....	176		C6400C.....	6			CC11TH.....	186		CM10280Z.....	118
C2010C.....	8		C6500C.....	6			CC2036.....	186		CM10318Z.....	118
C2210C.....	8		C8003WF.....	12			CC2036DP.....	186		CM10319Z.....	118
C2210C18.....	8		C8003WFS.....	12			CC2036P.....	186		CNCRK.....	26
C2210CBK.....	8		C8005WF.....	12			CC2243.....	186		CP2036.....	186
C2210SM.....	9		C8005WFS.....	12			CD2036.....	186		CSD100.....	14
C2220A.....	177		C8500S.....	12			CK6512A.....	43		CT1014.....	135
C2222A.....	177		C8503WF.....	12			CK6518A.....	43		CT1216.....	135
C2222C.....	177		C8503WFD.....	12			CK6524A.....	43		CT1217.....	135
C2222HD.....	177		C8504WF.....	12			CK6530A.....	43		CT1418.....	135
C2236.....	177		C8504WFD.....	12			CK6536A.....	43		CT1713TR.....	135
C2236H.....	177		C2400350.....	9			CK6544A.....	43		CTC13.....	46
C2237.....	177		C2400363.....	9			CK6548A.....	43		CTC15.....	46
C2410C.....	8		C2400368.....	9			CK6560A.....	43		CTC17.....	46
C2410C18.....	8		C2400413.....	9			CM1012.....	119		CTC24.....	46
C2410CBK.....	8		C2400450.....	9			CM1013.....	119		CTP13.....	46
C2410SM.....	9		CB1218KC.....	25			CM1040.....	118		CTP15.....	46
C2510C.....	8		CB1218QS.....	25, 43			CM1042.....	118		CTP17.....	46
C2852.....	11		CB1520KC.....	25			CM1042LP.....	118		CTP24.....	46
C2853.....	11		CB1520QS.....	25			CM1043.....	118		CW6C.....	176
C2854.....	11		CB1824KC.....	25			CM1045.....	118			
C2951BK.....	11		CB1824QS.....	25			CM1046.....	118			
C2952BK.....	11		CB6912WH.....	43			CM1049.....	118			
C2953BK.....	11		CBB6*.....	26			CM1100.....	117			
C3165*.....	7		CBCWLCTST.....	26			CM1100C14.....	116			
C3165TBL20.....	7										

D

DL300.....	144
DL300R.....	144
DL1826.....	144

Prod No	Page No	Prod No	Page No	Prod No	Page No	Prod No	Page No
E		H2005CLSS	19	HLA20	148	KP196KCBL	30
EAG01	109	H4000TBK	20			KP196KCGN	30
EAG02	109	H4003TBK	20	I		KP196KCRD	30
EAG04	109	H4004TBK	20	IC2220	145	KP196KCYL	30
EAG05	109	H4005CTBK	20	IC2250	145	KP256*	30
EAG06	109	H4005TBK	20	IC2250T	145	KP320*	30
EAG07	109	H4006TBK	20	IC2254	145	KPP97*	31
EAG08	109	H5000*	20	IT140	142	KPP196*	31
EAG09	109	H5000P*	21	IT160	142	KPP256*	31
EAG10	109	H5000S*	21	IT180	142	KPPS97	31
EAG11	109	H5003*	20	IT400	142	KPPS97WM	31
EP214	130	H5003P*	21	IT410	142	KPPS196	31
EP216	130	H5004*	20			KPpS196WM	31
EP217	130	H5004P*	21	J		KPPS256	31
EZK15	46, 47	H5005*	20	JC1945CB	187	KPPS256WM	31
EZK17	46, 47	H5005P*	21	JC1945L	187	KT0112K	46
EZKAPR	55	H5005S*	21	JC1945S	187	KT0115K	46
EZKFS	55	HAL01	75	JC1946	187	KT0118K	46
EZKHP88	51	HAL02	75			KT0124K	46
EZKKIT	55	HAL03	75	K		KT0212	46
EZKSHG	55	HAL04	75	KK401YL	53	KT0215	46
EZKSL	55	HAL05	75	KK403	53	KT0218	46
		HAL06	75	KL102	77	KT0224	46
		HAL09	75	KL108	77		
		HAL10	75	KL115	77	L	
		HAL11	75	KL116	77	L22C2951BK	11
		HAL12	75	KL118	77	L22CS2951BK	11
		HAL13	75	KL119	77	L24C2951BK	11
		HAL14	75	KL121	77	L320C	14
		HAL15	75	KL123	77	L360C	13
		HAL16	75	KL126	77	L2100	13
		HAL17	75	KL127	77	L2150	13
		HAL18	75	KL200	77	L2200C	9
		HAL20	75	KL201	77	L2202	13
		HAL21	75	KL203	77	L2203	13
		HAL22	75	KL204	77	L2204	13
		HAL23	75	KL205	77	L2400C	9
		HAL24	75	KL350	77	L2900	17
		HAL26	75	KL444	137	L2910BK	9
		HAL27	75	KL800	77	L2912BK	9
		HAL28	75	KL805	77	L2913BK	9
		HAL31	75	KL920	77	L2920BK	9
		HAL32	75	KL924	77	L2923BK	9
		HL8185	148	KL928	77	L3200	13
		HL8185B	148	KL928	77	L3400	13
		HL8185C	148	KLC28C	29	L3402	13
		HL8185G	148	KLP200	41	L3500	13
		HL8185GB	148	KLP250	41	L3502	13
		HL8185GC	148	KLRST	26		
		HL8195	148	KM15	47, 51, 53, 55		
		HL8195B	148	KM17	47, 51, 53, 55		
		HL8285	148	KP97*	30	M	
		HL8285B	148	KP97GN	30	MGA515	54
		HL8285G	148	KP97RD	30	MIN5440	83
		HL8285GB	148	KP196*	30	MIN5441	83
						MIN5442	83
						MIN5443	93

INDEX BY PART NUMBER

Prod No	Page No	Prod No	Page No	Prod No	Page No	Prod No	Page No
MIN5449.....	83	PB25.....	42	RCU64V2.....	29	RG36-1.....	173
MKBR901BE.....	52	PBS301.....	54	RCU128V2.....	29	RG36-1C.....	173
MKBR903.....	52	PC300N.....	143	RDC.....	177	RG36-2.....	173
MKBR903BE.....	52	PC600N.....	143	RDC1.....	177	RG36-2C.....	173
MKBR905.....	52	PC660.....	143	RE.....	170, 171, 172, 173, 174	RG36-3.....	173
MKBR905BE.....	52	PCD801.....	137	RE9.....	170	RG36-3C.....	173
MKQUG.....	52	PCL2.....	14	RE9C.....	170	RG36-4.....	173
MKQUGBE.....	52	PCL3ADJ.....	14	RE16.....	171	RG36-4C.....	173
MODBASE.....	17	PS103.....	129	RE16C.....	171	RG36-5.....	173
MODBD2002.....	16	PS103AT.....	129	RE25.....	172	RG36-5C.....	173
MODBD2002KIT.....	16	PS203.....	129	RE25C.....	172	RG49.....	168, 173
MODBD20021.....	16	PS204.....	128	RE36.....	173	RG49-1.....	173
ModBFD.....	16	PS204AST.....	128	RE36C.....	173	RG49-1C.....	173
MODCC100.....	17	PS304.....	129	RE49.....	173	RG49-2.....	173
MODCL100.....	17	PS304AT.....	129	RE49C.....	173	RG49-2C.....	173
MODGH100.....	16	PS501N.....	129	REW20S.....	169	RG49-3.....	173
MODH60030GN.....	17	PS502N.....	129	REW20SC.....	169	RG49-3C.....	173
MODH6003SN.....	17	PS601N.....	129	REW30S.....	169	RG49-4.....	173
MODH60050GN.....	17	PS601NC.....	128	REW30SC.....	169	RG49-4C.....	173
MODH6005SN.....	17	PS602N.....	129	RF.....	174	RG49-5C.....	173
MODL2900KIT.....	15	PS603N.....	129	RFP.....	175	RHC.....	177
MODL29001.....	15	PS701B.....	129	RG9.....	168, 170	ROP.....	174
MODL29002.....	15	PS702.....	129	RG9-1.....	170	RP.....	174
MODMP16.....	16	PS801B.....	129	RG9-1C.....	170	RPC.....	175
ModMP16Kit.....	16	PS802.....	129	RG9-2.....	170	RSP.....	175
MODMP161.....	16	PS6012.....	129	RG9-2C.....	170	RTP.....	174
MODP4900CC.....	17	PSD13CH.....	112	RG9-3.....	170	RW20.....	168, 169
MODP4900CL.....	17	PSD13EH.....	112	RG9-3C.....	170	RW20-1.....	169
MODTRAY.....	17	PSD21CH.....	112	RG9-4.....	170	RW20-1C.....	169
MP12.....	41	PSD21DEH.....	112	RG9-4C.....	170	RW20-2.....	169
MP13.....	41	PSD21EH.....	112	RG9-5.....	170	RW20-2C.....	169
MP14.....	41			RG9-5C.....	170	RW20-3.....	169
MP16.....	41	Q		RG16.....	168, 171	RW20-3C.....	169
MP19.....	41	QSWLCT.....	26	RG16-1.....	171	RW20-4C.....	169
MPL12PR.....	41			RG16-1C.....	171	RW20-C.....	169
MPL13PR.....	41	R		RG16-2.....	171	RW30.....	168, 169
MPL14PR.....	41	R2000TBK.....	68	RG16-2C.....	171	RW30-1.....	169
MPL16PR.....	41	R2000TBL.....	68	RG16-3.....	171	RW30-1C.....	169
MPL19PR.....	41	R2000WH.....	68	RG16-3C.....	171	RW30-2.....	169
		R3600TBK.....	68	RG16-4.....	171	RW30-2C.....	169
O		R3600WH.....	68	RG16-4C.....	171	RW30-3.....	169
OP305.....	130	R3670BKSS.....	68	RG16-5.....	171	RW30-3C.....	169
OP316.....	130	R3670SS.....	68	RG16-5C.....	171	RW30-4C.....	169
OP371.....	130	R3670WHCL.....	68	RG25.....	168, 172	RW30-C.....	169
		R4000TBK.....	68	RG25-1.....	172	RW107 80 1226.....	71
P		R4000TBL.....	68	RG25-1C.....	172	RW107 80 1227.....	71
P614.....	136	R4000WH.....	68	RG25-2.....	172	RW107 80 1228.....	71
P614R.....	136	R4070BKSS.....	68	RG25-2C.....	172	RW107 80 1230.....	71
P4100.....	18	R4070SS.....	68	RG25-3.....	172	RW107 80 1231.....	71
P4100BK.....	18	R4070WHCL.....	68	RG25-3C.....	172	RW107 80 1232.....	71
P4900.....	18	RB.....	174	RG25-4.....	172	RW107 80 1233.....	71
P4900BK.....	18	RC16.....	168, 175	RG25-4C.....	172	RW107 80 1234.....	71
PB17.....	42	RC16-1.....	175	RG25-5.....	172	RW107 80 1255.....	71
PB20-6.....	42	RC20.....	168, 175	RG25-5C.....	172	RW107 80 1256.....	71
PB20-12.....	42	RC20-1.....	175	RG36.....	168, 173	RW107 80 1257.....	71

Prod No	Page No	Prod No	Page No	Prod No	Page No	Prod No	Page No
S							
S30TBK	70	SH970BKSS	69	T1370SS	61	UPM17BK	47, 51
S30TBL	70	SH970SS	69	T1370WHCL	61	V	
S46TBK	70	SH970WHCL	69	T1390	61	VM5280BK	40, 43
S46TBL	70	SHF900TBK	69	T1390TBK	61, 68	VM5280BK-12	40
S275	98	SHF900TBL	69	T1390TBL	61, 68	VM5280CL	40, 43
S277	98	SHF900WH	69	T1400TBK	52, 60, 61, 62	VM5280CL-12	40
S279	98	SHF970BKSS	69	T1400TBKHW	52, 60, 62	VM5280RD	40, 43
S280	98	SHF970SS	69	T1400TBL	52, 60, 61, 62	VM5280RD-12	40
S282	98	SHF970WHCL	69	T1400WH	52, 60, 61, 62	VM5280WN	40, 43
S285	98	SI4550	35	T1470BKSS	52, 60, 61, 62	VM5280WN-12	40
S286	98	SI5000	34	T1470SS	52, 60, 61, 62	W	
S287	98	SI5500	34	T1470WHCL	52, 60, 61, 62	WF107 80 1204	71
S310	96	SI6000	32	T1490TBK	52, 60, 61, 62	WF107 80 1206	71
S312	96	SI6100	32	T1490TBL	52, 60, 61, 62	WP107 80 1202	71
S314	96	SI6150BPAF	32	T1700TBK	65, 66	WP107 80 1203	71
S900TBK	69	SI6500	32	T1700TBL	65, 66	WP9070BKSS	71
S900TBL	69	SI7000	34	T1720	66	WP9070SS	71
S900WH	69	SI7500	34	T1755TBK	65, 66, 68	WP9070WHCL	71
S970	69	SI9000	34, 35	T1755TBL	65, 66, 68	WPM25	131
S1300TBK	69	SI9500	34, 35	T1800	67	WPM45	131
S1300TBL	69	SICART60	33	T1900	67	WPM85	131
S1300WH	69	SICART61	33	T1905	67	WS107 80 1207	71
SBC1521	186	SILD6000	33	T1950	67	WS107 80 1208	71
SBC2031	186	ST250	14	T7000TBK	62	X	
SBCA30000	186	ST250WM	14	T7000TBL	62	X101924	12
SBC240	186	ST500	14	T7000WH	62	X101987	12
SBC245	186	STK1006	29	T7090	62	X102268	33
SBCRKIT	186	STK1006GRL	29	T7400TBK	60	X102273	33
SC25	137	STK1006PRL	29	T7400TBL	60	XC2022	9
SC26	137	STK1006RDL	29	T7470BKSS	60	XC2226	9
SC27	137	STK1006YLL	29	T7470SS	60	XC2226BK	9
SC29	137	STK1008	29	T7470WHCL	60	XC2426	9
SC32	112	STL511	29	T8006BKADA	62	XC2426BK	9
SC40	137	SW12	28	T8008BKUNV	62	XC2526	9
SCDGPC13	43	SW18	28	T8400TBK	61	XDL3000H	144
SF30TBK	70	SW1218	28	T8400TBL	61	U	
SF30TBL	70	SW1218SC	28	T8400WH	61	UCMX13BK	47, 51
SF46TBK	70	SWX100	28	T8400SSADA	62	UCMX15BK	47, 51
SF46TBL	70	T		T8408SSUNV	62	UCMX17BK	47, 51
SF900TBK	69	T12	50	TC7501	25	UHP1010BK	51
SF900TBL	69	T400TBK	63	TC7502	25	UPM15BK	47, 51
SF900WH	69	T400TBL	63	TC7503	25	S	
SF970	69	T451XC	63	TC121812	25	SG10	54
SF1300TBK	69	T850TBK	64, 65	TC121812GV	25	SG10-L	54
SF1300TBL	69	T850TBL	64, 65	TC152012	25	SG10-M	54
SF1300WH	69	T950TBK	64	TC152012GV	25	SG10-S	54
SG10	54	T950TBL	64	TC182412	25	SG10-XL	54
SG10-L	54	T1100TBK	64	TC182412GV	25	SH900TBK	69
SG10-M	54	T1100TBL	64	T			
SG10-S	54	T1100WH	64	T1217	50	SH900TBL	69
SG10-XL	54	T1300TBK	61, 68	T1300TBK	61, 68	SH900WH	69
SH900TBK	69	T1300TBL	61, 68	T1370BKSS	61	U	
SH900TBL	69	T1370BKSS	61	S			
SH900WH	69						

1. Terms and Method of Payment

- a. All orders are subject to approval and acceptance by SELLER. No order accepted by SELLER shall be subject to cancellation, termination, suspension, change, reduction, cutback or other modification except with SELLER'S prior written consent.
- b. Our standard terms of payment are net 30 days from invoice date. The amount of terms of credit, if extended, may be changed or credit withdrawn by SELLER at any time. No orders will be shipped on a COD basis.
- c. Prices do not include federal, state or local taxes, duties or other levies, now or hereafter enacted, applicable to the items deliverable under the sales order or invoice (hereinafter called ITEMS), which taxes, duties, or other levies will be added by SELLER to the sales price and will be paid by BUYER unless BUYER provides SELLER with a proper exemption certificate.
- d. Packaging for commercial shipment is included in the contract price. Any special packaging, crating or shipping instructions must be noted on BUYER'S original order and acknowledged by SELLER.

2. Title and Delivery

The ITEMS shall be delivered F. O. B. SELLER'S plant, and title thereto shall pass to BUYER, upon SELLER'S delivery of the ITEMS to a common carrier for shipment to BUYER. All items from the San Jamar catalog may be combined to obtain prepaid freight, regardless of the shipping point. Freight is prepaid on all orders totaling \$2,000 net or more to one destination within the contiguous 48 United States. Freight on prepaid International Shipments will be paid on normal ground transportation from shipping point to the consignee. When the order qualifies for prepaid freight, Seller shall have the right to select the means of transportation. If Buyer requires a means of transportation other than the one normally selected by Seller, any extra cost incurred by reason of using such other means shall be paid by Buyer. Palletized international orders requiring heat treated pallets will be charged \$4.25 net per pallet. International orders requiring heat treated certified bark-free pallets will be charged \$18.50 net per pallet. Any accessorial charges incurred because of a customer request will be the responsibility of the requester. Any items backordered from a prepaid shipment will be forwarded prepaid. Items backordered from ex works shipments will be forwarded ex works.

3. Inspection and Acceptance

Thoroughly inspect all shipments. Do not accept a damaged or short shipment until exception is noted on the freight bill. BUYER will be held responsible for all shipments with freight bills signed free and clear. If concealed damage is discovered, contact the freight company immediately for inspection. Concealed damage must be reported to the carrier within 7 days of receipt. All damaged goods and shortages that are not properly documented and reported upon receipt become the sole responsibility of the BUYER.

4. Patent Indemnification

SELLER shall protect and indemnify BUYER and its directors, officers, agents and employees against all claims for damages or profits, including all reasonable costs incurred by BUYER in connection therewith, arising from infringement of patents, copyrights, trademarks or misappropriation of designs.

5. Returns and Cancellations

No returns will be accepted without an authorization number from Carlisle Customer Service. An authorization number may be obtained by calling 800 248 9826 and requesting a Return Authorization from Customer Service. All requests for return must occur within 90 days of the original shipment of the product unless special authorization is obtained. Merchandise returned without authorization will be refused and returned to the customer, freight collect.

Any merchandise must be returned freight prepaid, and is subject to a minimum of 20% restocking charge.

All returned goods must reference the original invoice and purchase order. Returned goods must be in original standard packs and in unused salable condition. Special Order Products and discontinued items will not be accepted for exchange or return.

This includes any articles custom imprinted or modified for purchaser.

6. General

- a. All prices are list and subject to change without notice. Orders from authorized accounts will be accepted with the understanding that prices are those in effect at the time of shipment. These prices are exclusive of all sales taxes which may be levied by State, Federal, or City governments.
- b. Orders less than \$100.00 net will be charged a \$10.00 handling fee. The initial order requirement for a new customer is \$2,000 net, and must be accompanied by a tax exemption certificate.
- c. Orders calling for less than a standard case pack will be charged \$5.00 net each per broken case.
- d. Orders requiring 3rd party freight billing will be assessed a \$5.00 per order processing charge. .
- e. No ITEMS to be furnished hereunder shall be exported by BUYER unless SELLER is first notified in writing of the intention to so export and all applicable regulations and licenses are complied with and obtained by BUYER or its customer.
- f. SELLER hereby certifies that the goods described herein of its manufacture will be produced in compliance with all applicable requirements of Sections 6, 7 and 12 of the Fair Labor Standards Act, as amended, and all order of the United States Department of Labor issued under Section 14 thereof. SELLER further certifies that it is in compliance with the Equal Employment Opportunity clause in Section 202, paragraphs 1 through 7 of Executive Order 11246, as amended, relative to equal employment opportunity and the implementing Rules and Regulations of the Office of Federal Contract Compliance.
- g. SELLER is not responsible for typographical errors made in any of its publications or for stenographic or clerical errors made in preparation of quotations, sales orders, acknowledgments, or invoices. All such errors are subject to correction.
- h. This agreement shall be governed by the laws of the state of Wisconsin.
- i. SELLER'S "Terms and Conditions" as set forth above shall govern all transactions. Any inconsistent terms of BUYER wherever set forth and whether oral or written, shall not be binding upon SELLER unless agreed to by SELLER in writing. No waiver or exception to any of the hereinabove enumerated conditions or any of the special terms and provisions relating to any order shall be binding upon SELLER unless agreed to in writing by SELLER.
- j. SELLER reserves the right to change or discontinue the color, design, component content or price of any ITEMS in SELLER'S catalog or published price lists without prior notice at any time.

The specifications and prices listed in this document are subject to change. San Jamar does not assume responsibility for typographical errors.

San Jamar

555 Koopman Lane
Elkhorn, Wisconsin 53121
USA
T: +1.262.723.6133
F: +1.262.226.8664
info@sanjamar.com
www.sanjamar.com

© Copyright San Jamar, Inc. 2019

Canada

3280 Bloor Street West
Suite 1140
11th Floor, Centre Tower
Toronto, ON M8X 2X3
CANADA
T: +1.262.723.6133
F: +1.262.226.8664
canada@sanjamar.com

Europe

Schoorstraat 26a, bus 1
2220 Heist-op-den-Berg
BELGIUM
T: +32 15 22 81 40
F: +32 15 22 81 48
emea@sanjamar.com

México

Av. Paseo de la Reforma No. 350 - 10
Col. Juárez
Deleg. Cuauhtemoc, CP 06600
MEXICO, D.F.
T: +52 (55) 3626 0772
mexico@sanjamar.com

Carlisle FoodService Products

4711 East Hefner Road
Oklahoma City, OK 73131
T: +1 405.475.5600
F: 800.872.4701
www.carlislefsp.com
www.cfsbrands.com

© Copyright CFS Brands 2019

CFSBRANDS®