

REFRIGERATOR MANUFACTURER
Turbo air
 more durable, efficient, beautiful

4184 E. Conant St.
 Long Beach, CA 90808
 Tel. 310-900-1000
 Fax. 310-900-1077
www.turboairinc.com

Project:	
Model #:	
Item #:	
Available W/H:	Qty:
Approval:	
AIA #:	SIS #:
CSI Section 11400	

Sushi Cases

Display Cases
 Refrigerated Sushi Cases

Model : SAS-70L-N
SAS-70R-N

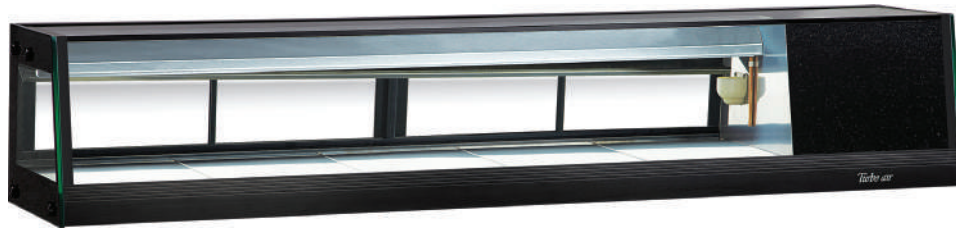

SAS-70R-N

LED interior lighting

LED lighting is energy efficient and illuminates with eight times the clarity and brightness.

Digital temperature display and control

Digital technology provides precise and constant temperatures throughout the cabinet. This allows food products to remain fresh over an extended period of time.

≡ FEATURES & BENEFITS ≡

- **Hydrocarbon refrigerants (R-290)**
 With innovative and eco-friendly technology, Turbo Air brings you hydrocarbon refrigerators designed to meet DOE's Energy Conservation Standards in 2017 and to use EPA's SNAP Program approved HC refrigerants. Hydrocarbon refrigerants do not deplete the ozone layer and have very low contribution to global warming (ODP-0, GWP-3).
- **Ambient temperature range 50°F ~ 80°F, saturation temperature 39°F**
- **Straight front glass for maximum visibility**
- **Slightly inclined bottom for better drainage**
- **Larger interior for optimized display effect**
- **Stainless steel solid food plates**
- **Low-E coated, tempered glass doors with durable plastic door handles at chef side**
- **Side mount compressor makes it easy to be serviced without being moved**
- **Elegant contemporary Euro design enhances any store application**
- **Easy cleaning and excellent durability**
- **Condenser located on left or right from the front view**
- **Refrigerator maintains 35°F ~ 41°F for the best in food preservation**
- **Auto Defrost**
- **Hot Gas Loop & Wicking Pad**



Model	Compressor Location	Sliding Door	CU./FT.	Bottom Shelves	HP	AMPS	Crated Weight (lbs.)	L x D* x H (inches)
SAS-70L-N SAS-70R-N	Left Right	4	2.3	5	1/6	4.6	182	70 7/8 x 14 1/2 x 13 1/2

Model : SAS-70L-N / SAS-70R-N

ELECTRICAL DATA	
Voltage	115/60/1
Plug Type	 NEMA 5-15P
Full Load Amperes	4.6
Compressor HP	1/6
Refrigerant	R-290
Cord Length (ft.)	47/8
DIMENSIONAL DATA	
Net Capacity (cu. ft.)	2.3
Ext. Length Overall (in.†)	70 ⁷ / ₈ (1800mm)
Ext. Depth Overall (in.)	14 ¹ / ₂ (359mm)
Ext. Height Overall (in.)	13 ¹ / ₂ (343mm)
# of Sliding Doors	4
# of Bottom Shelves	5
Shelf Size (L x D) (in.)	11 x 11
Net Weight (lbs.)	160
Gross Weight (lbs.)	182

Design and specifications subject to change without notice.
Actual shipping weight may differ due to extra packing materials for product protection.
* Depth does not include 5/8" for drain.

■ **WARRANTY : 2 Year Parts and Labor Warranty**
Additional 3 Year Warranty on Compressor

■ STANDARD FEATURES

- **Anti-corrosion coated evaporator**
- **Self-contained system**
- **No plumbing required**
- **Simple plug-in installation**
- **Recommended operating conditions**
SAS models are designed to operate in environments where temperature & humidity do not exceed 75°F and 55% relative humidity.

PLAN VIEW

(unit : inch)

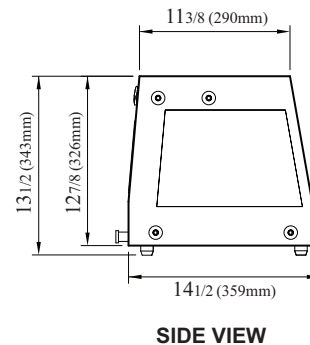
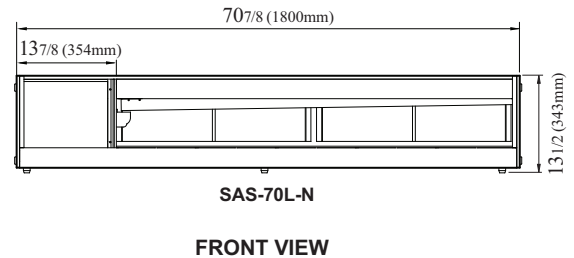
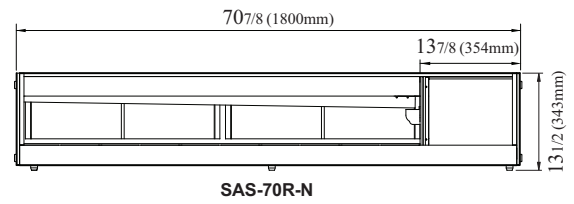
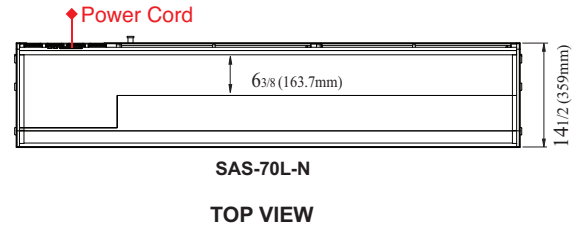
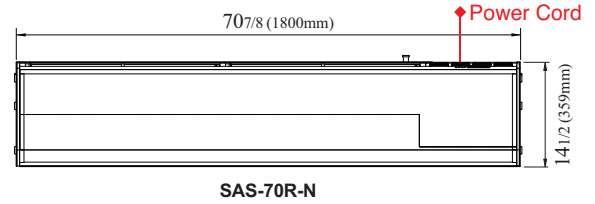

Ver.20211215



■ Turbo Air : 800-627-0032 ■ GK : 800-500-3519
■ Warranty : 800-381-7770 ■ AC : 888-900-1002